



Forti dei nostri cinquant'anni di esperienza nel mondo dell'illuminazione, ci presentiamo con un nuovo e rinnovato approccio comunicativo, riflettendo l'evoluzione continua che ci ha portato ad essere un punto di riferimento nell'industria.

Da un'azienda familiare a una realtà aziendale d'avanguardia, abbiamo abbracciato i nostri valori autentici e li abbiamo trasformati in una risposta unica e personale al presente, con uno sguardo rivolto al futuro. La nostra storia è una fusione di passione artigianale e ricerca tecnologica, creando corpi illuminanti che non solo illuminano gli spazi, ma li trasformano, generando nuove atmosfere e emozioni.

Ogni lampada che produciamo è il risultato di un processo creativo che integra design e ricerca, con un'attenzione ai dettagli che garantisce un impatto estetico forte e duraturo. Il nostro impegno per l'innovazione e la sostenibilità è evidente in ogni fase della produzione.

Oltre alla cura artigianale tipicamente italiana, investiamo in tecnologie all'avanguardia che ci permettono di offrire soluzioni di illuminazione che non solo soddisfano le esigenze funzionali, ma anche quelle emotive e sensoriali degli utenti. Il nostro concetto di "made in Italy" va oltre la semplice produzione: diventa uno stile di vita. Le nostre lampade non sono solo strumenti per illuminare gli spazi, ma elementi essenziali nella progettazione degli ambienti, promettendo di emozionare attraverso il design della luce. Siamo orgogliosi della nostra storia, ma siamo ancora più entusiasti del futuro che ci attende.

Con un occhio attento alle tendenze emergenti e un impegno costante verso l'innovazione e la sostenibilità, continueremo a guidare il settore dell'illuminazione moderna, ispirando e affascinando i nostri clienti in tutto il mondo. Unendo la nostra passione per l'artigianato con la nostra visione tecnologica, illumineremo il futuro con la stessa dedizione e creatività che ci ha portato fino a oggi.

L'illuminazione non è semplicemente una questione di luce; è un modo per trasformare gli spazi, generando emozioni e creando atmosfere uniche. Questo è ciò che ci guida ogni giorno, qui da Cattaneo Illuminazione.

Con una storia di cinquant'anni nel mondo dell'illuminazione, siamo cresciuti da un'azienda familiare a un'organizzazione d'avanguardia, mantenendo sempre saldi i nostri valori autentici. Abbiamo imparato che l'illuminazione non è solo una questione di funzionalità, ma di bellezza e ispirazione. È per questo che ogni nostra lampada è il risultato di un processo creativo che fonde il meglio dell'artigianato italiano con la ricerca tecnologica più innovativa.

Il nostro impegno per l'innovazione e la sostenibilità è al centro di tutto ciò che facciamo. Non solo investiamo in tecnologie all'avanguardia, ma ci assicuriamo che ogni fase della nostra produzione rispetti gli standard più elevati di sostenibilità ambientale. Per noi, il "made in Italy" non è solo un marchio di origine; è un impegno per uno stile di vita che celebra l'eccellenza artigianale e il rispetto per l'ambiente.

Guardiamo al futuro con entusiasmo e determinazione. Continueremo a essere leader nel settore dell'illuminazione moderna, guidati dalla nostra passione per l'artigianato e dalla nostra visione tecnologica. Vogliamo continuare a ispirare e affascinare i nostri clienti in tutto il mondo, illuminando il futuro con la stessa dedizione e creatività che ci ha contraddistinto finora.

Unisciti a noi in questo viaggio verso un futuro luminoso e sostenibile. Con Cattaneo Illuminazione, ogni ambiente diventa un'opera d'arte, illuminata con la nostra passione e la nostra innovazione.

Building on our fifty years of experience in the lighting world, we present ourselves with a new and renewed communicative approach, reflecting the continuous evolution that has led us to be a point of reference in the industry.

From a family business to a cutting-edge company, we have embraced our authentic values and transformed them into a unique and personal response to the present, with an eye to the future. Our story is a fusion of passionate craftsmanship and technological research, creating luminaires that not only illuminate spaces, but transform them, generating new atmospheres and emotions.

Each lamp we produce is the result of a creative process that integrates design and research, with an attention to detail that guarantees a strong and lasting aesthetic impact. Our commitment to innovation and sustainability is evident at every stage of production.

In addition to our typically Italian craftsmanship, we invest in cutting-edge technologies that allow us to offer lighting solutions that not only meet the functional requirements, but also the emotional and sensory needs of users. Our concept of 'made in Italy' goes beyond mere production: it becomes a way of life. Our lamps are not just tools for illuminating spaces, but essential elements in the design of environments, promising to excite through the design of light. We are proud of our history, but we are even more excited about the future that lies ahead.

With a keen eye for emerging trends and an unwavering commitment to innovation and sustainability, we will continue to lead the modern lighting industry, inspiring and captivating our customers around the world. Combining our passion for craftsmanship with our technological vision, we will illuminate the future with the same dedication and creativity that has brought us to this day.

Lighting is not simply a matter of light; it is a way of transforming spaces, generating emotions and creating unique atmospheres. This is what drives us every day here at Cattaneo Illuminazione.

With a history of fifty years in the lighting world, we have grown from a family business to a state-of-the-art organisation, always holding fast to our authentic

values. We have learnt that lighting is not just about functionality, but about beauty and inspiration. That is why each of our lamps is the result of a creative process that fuses the best of Italian craftsmanship with the most innovative technological research.

Our commitment to innovation and sustainability is at the heart of everything we do. Not only do we invest in cutting-edge technology, we ensure that every stage of our production meets the highest standards of environmental sustainability. For us, 'made in Italy' is not just a mark of origin; it is a commitment to a lifestyle that celebrates excellence in craftsmanship and respect for the environment.

We look to the future with enthusiasm and determination. We will continue to be a leader in modern lighting, driven by our passion for craftsmanship and our technological vision. We want to continue to inspire and fascinate our customers around the world, illuminating the future with the same dedication and creativity that has distinguished us so far. Join us on this journey towards a bright and sustainable future. With Cattaneo Illuminazione, every room becomes a work of art, illuminated with our passion and innovation.

Aufbauend auf unserer fünfzigjährigen Erfahrung in der Welt der Beleuchtung präsentieren wir uns mit einem neuen und erneuerten Kommunikationsansatz, der die kontinuierliche Entwicklung widerspiegelt, die uns zu einem Bezugspunkt in der Branche gemacht hat.

Von einem Familienbetrieb zu einem avantgardistischen Unternehmen, haben wir unsere authentischen Werte angenommen und sie in eine einzigartige und persönliche Antwort auf die Gegenwart verwandelt, mit einem Blick in die Zukunft. Unsere Geschichte ist eine Verschmelzung von leidenschaftlicher Handwerkskunst und technologischer Forschung, die Beleuchtungskörper hervorbringt, die Räume nicht nur beleuchten, sondern sie auch verwandeln und neue Atmosphären und Emotionen schaffen.

Jede von uns hergestellte Leuchte ist das Ergebnis eines kreativen Prozesses, der Design und Forschung miteinander verbindet und durch die Liebe zum Detail eine starke und dauerhafte ästhetische Wirkung gewährleistet. Unser Engagement für Innovation und Nachhaltigkeit ist in jeder Phase der Produktion sichtbar.

Neben der typisch italienischen Handwerkskunst investieren wir in Spitzentechnologien, die es uns ermöglichen, Beleuchtungslösungen anzubieten, die nicht nur die funktionalen, sondern auch die emotionalen und sensorischen Bedürfnisse der Nutzer erfüllen. Unser Konzept des "Made in Italy" geht über die reine Produktion hinaus: Es wird zu einer Lebenseinstellung. Unsere Lampen sind nicht nur Werkzeuge, um Räume zu beleuchten, sondern wesentliche Elemente bei der Gestaltung von Umgebungen, die durch das Design von Licht zu begeistern versprechen. Wir sind stolz auf unsere Geschichte, aber wir sind noch begeisterter von der Zukunft, die uns erwartet.

Mit einem scharfen Blick für aufkommende Trends und einem unerschütterlichen Engagement für Innovation und Nachhaltigkeit werden wir auch in Zukunft die moderne Beleuchtungsindustrie anführen und unsere Kunden auf der ganzen Welt inspirieren und faszinieren. Indem wir unsere Leidenschaft für handwerkliches Können mit unserer technologischen Vision verbinden, werden wir die Zukunft mit

demselben Engagement und derselben Kreativität beleuchten, die uns bis zum heutigen Tag gebracht haben.

Beleuchtung ist nicht nur eine Frage des Lichts, sondern auch eine Möglichkeit, Räume zu verwandeln, Emotionen zu wecken und einzigartige Atmosphären zu schaffen. Das ist es, was uns hier bei Cattaneo Illuminazione jeden Tag antreibt.

Mit einer fünfzigjährigen Geschichte in der Welt der Beleuchtung haben wir uns von einem Familienunternehmen zu einer hochmodernen Organisation entwickelt, wobei wir stets an unseren authentischen Werten festhalten. Wir haben gelernt, dass es bei der Beleuchtung nicht nur um Funktionalität, sondern auch um Schönheit und Inspiration geht. Deshalb ist jede unserer Leuchten das Ergebnis eines kreativen Prozesses, der das Beste der italienischen Handwerkskunst mit der innovativsten technologischen Forschung verbindet.

Unser Engagement für Innovation und Nachhaltigkeit steht im Mittelpunkt unseres Handelns. Wir investieren nicht nur in Spitzentechnologie, sondern stellen auch sicher, dass jede Phase unserer Produktion den höchsten Standards der ökologischen Nachhaltigkeit entspricht. Für uns ist "Made in Italy" nicht nur ein Herkunftszeichen, sondern ein Bekenntnis zu einem Lebensstil, der handwerkliche Exzellenz und Respekt für die Umwelt zelebriert.

Wir blicken mit Begeisterung und Entschlossenheit in die Zukunft. Wir werden weiterhin führend in der modernen Beleuchtung sein, angetrieben von unserer Leidenschaft für das Handwerk und unserem technologischen Weitblick. Wir wollen unsere Kunden auf der ganzen Welt weiterhin inspirieren und faszinieren und die Zukunft mit der gleichen Hingabe und Kreativität beleuchten, die uns bisher ausgezeichnet hat.

Begleiten Sie uns auf dieser Reise in eine helle und nachhaltige Zukunft. Mit Cattaneo Illuminazione wird jeder Raum zu einem Kunstwerk, das mit unserer Leidenschaft und Innovation beleuchtet wird.

collection - index



Waterfalls
p 10



Cleo
p 20

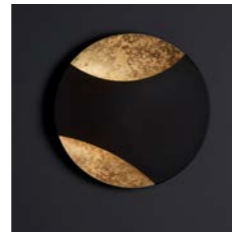

Lunatica
p 30

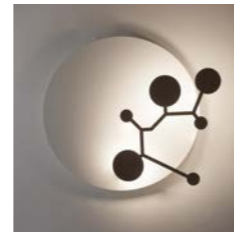

Orione
p 40



Logica
p 68



Kami Up&Down
p 76



Kami
p 82



Katana
p 92



Heron
p 104



Well
p 120



**Olimpia
Olimpia Touch,**
p 126

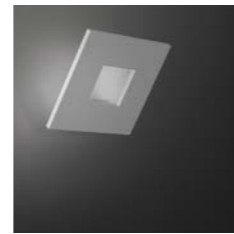

Square
p 142



Rays
p 150



Nassa
p 158



Basalt
p 166



Ninfea
p 172



Mickey
p 178



Biquadro
p 194



Centreline
p 200



Sesamo
p 206

collection - index



Abbraccio
p 214

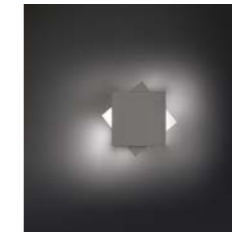

Quadretto
p 220



Cubick
p 226



**Street
Street System**
p 240



Fuorisquadra
p 254



Biscotto
p 260



Plateau
p 266



Tratto
p 272



Bolle
p 284



Adjustable
p 290



Nuvola
p 296



Cloud
p 306

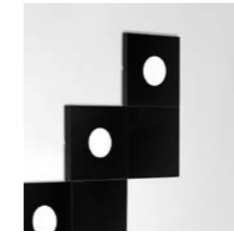

Domino
p 310



Smith
p 318



Vintage
p 330

Lucilla System

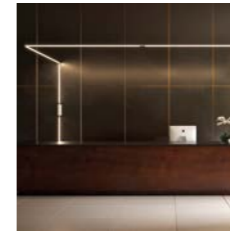

Lucilla System
p 342



Lucilla Floor
p 380



Lucilla Suspension
p 392

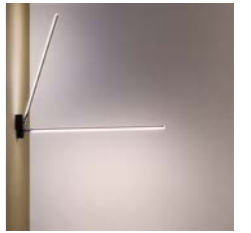

Lucilla Wall/Ceiling
p 398

Easy System



Drop
p.416



Mini Soft
p.424



Time
p.434



Mini Mercury
p.440



Stretch
p 446



E.R.
p 452

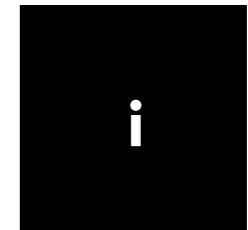

Installation
p 460

Head System



Nuts
p 468



Ball
p 474



Cone
p 478

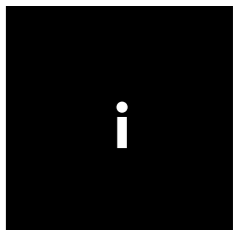

Installation
p 482

Waterfalls

design by C. Cattaneo

La lampada a sospensione Waterfalls incarna l'incontro tra design contemporaneo e personalizzazione senza precedenti. Composta da una serie di moduli LED singolarmente selezionabili, questa lampada consente di creare un'illuminazione unica e su misura per qualsiasi ambiente.

Ora, con l'aggiunta dei nuovi colori oro, bronzo, cromo e nero, la Waterfalls si distingue per la sua versatilità e l'eleganza senza tempo. Sia che tu stia cercando di aggiungere un tocco di lusso alla tua casa o di creare un'atmosfera accattivante in uno spazio commerciale, la Waterfalls si dimostra essere la scelta perfetta per chi ricerca l'illuminazione di qualità superiore con un tocco di personalità.

Rendi il tuo ambiente unico con la Lampada a Sospensione Waterfalls e lascia che la tua creatività si esprima attraverso la luce.

The Waterfalls pendant lamp embodies the meeting of contemporary design and unprecedented customisation. Consisting of a series of individually selectable LED modules, this lamp allows for the creation of unique, customised lighting for any environment.

Now, with the addition of new gold, bronze, chrome and black colours, Waterfalls stands out for its versatility and timeless elegance. Whether you are looking to add a touch of luxury to your home or create an eye-catching atmosphere in a commercial space, Waterfalls proves to be the perfect choice for those seeking premium lighting with a personal touch.

Make your environment unique with Waterfalls Pendant Lamp and let your creativity express itself through light.

Die Waterfalls Pendelleuchte verkörpert das Zusammentreffen von zeitgenössischem Design und beispielloser Individualität. Bestehend aus einer Reihe von individuell auswählbaren LED-Modulen, ermöglicht diese Leuchte die Schaffung einer einzigartigen, individuellen Beleuchtung für jede Umgebung.

Mit den neuen Farben Gold, Bronze, Chrom und Schwarz zeichnet sich die Waterfalls durch ihre Vielseitigkeit und zeitlose Eleganz aus. Ganz gleich, ob Sie Ihrem Zuhause einen Hauch von Luxus verleihen oder eine auffällige Atmosphäre in einem Geschäftsraum schaffen möchten, die Waterfalls erweist sich als die perfekte Wahl für alle, die eine hochwertige Beleuchtung mit persönlicher Note suchen.

Machen Sie Ihre Umgebung mit der Waterfalls Pendelleuchte einzigartig und lassen Sie Ihre Kreativität durch Licht zum Ausdruck kommen.

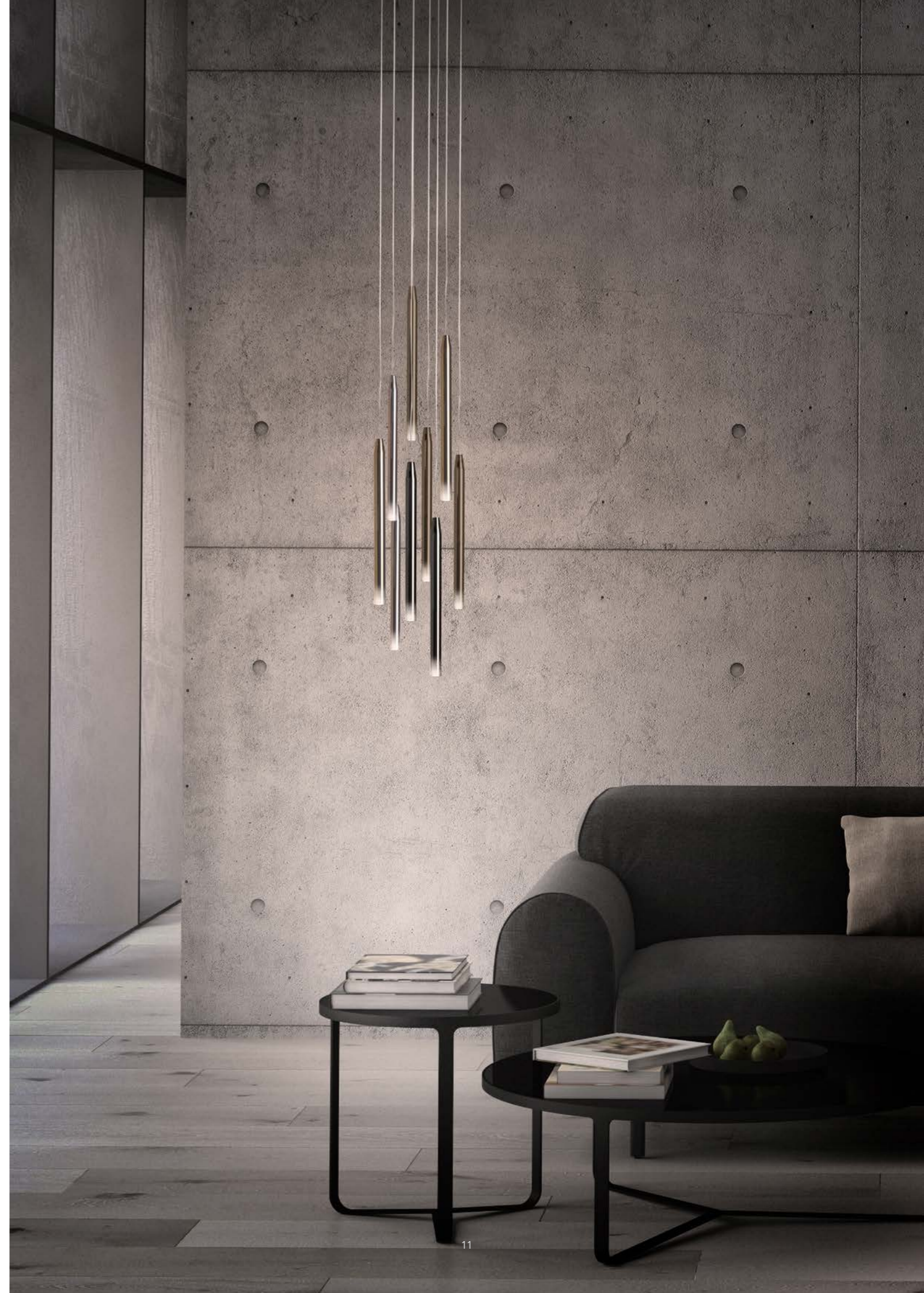



Waterfalls | Suspension



M151 modulo LED
 1x2W LED 700 mA 4000°K
 upon request 3000°K
 Net weight 114gr
 CE IP20



Transparent Satin

M161 modulo LED
 1x2W LED 700 mA 4000°K
 upon request 3000°K
 Net weight 114gr
 CE IP20

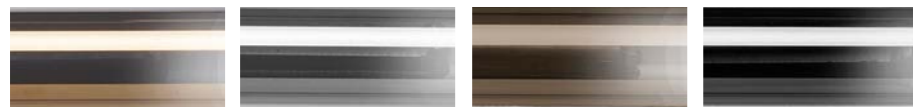

Gold Chrome Bronze Black

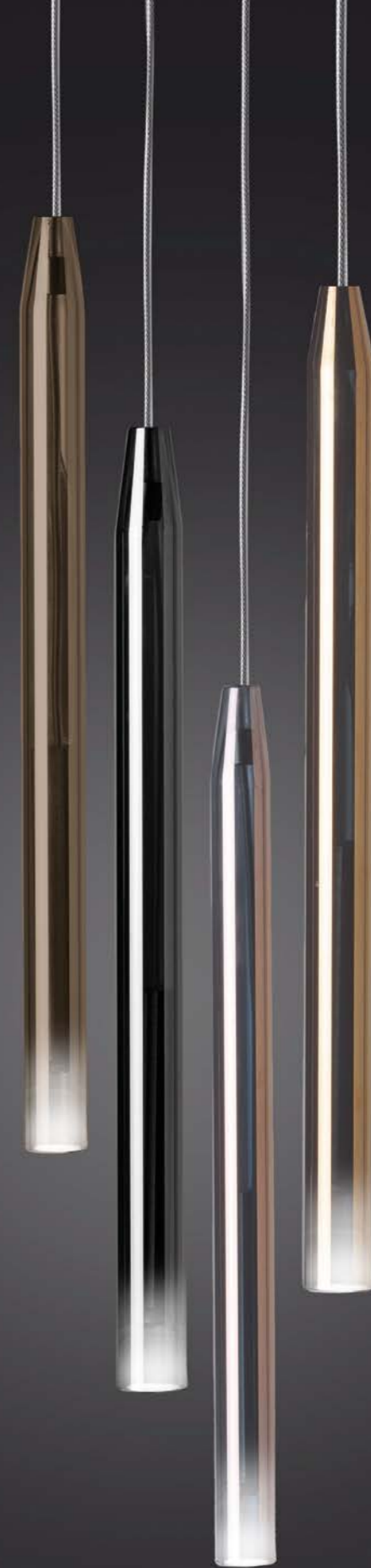
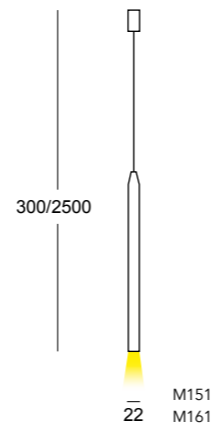



Transparent Satin



Customised lamp composed of:
B151/29 + 6 pcs M151 + D151/7
CE IP20



B 151/10
 up to 2 modules
 Net weight 220gr
 Gross weight 686gr (with 2 Susp.)
 Volume m³ 0,009
 CE IP20

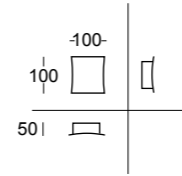

B 152/90
 up to 16 modules
 Net weight 1810gr
 Gross weight 5327gr (with 16 Susp.)
 Volume m³ 0,052
 CE IP20

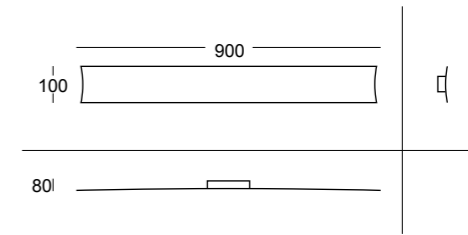

B 151/20
 up to 4 modules
 Net weight 902gr
 Gross weight 1736gr (with 4 Susp.)
 Volume m³ 0,013
 CE IP20

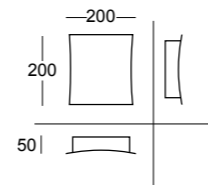

M151 modulo LED
 1x2W LED 700 mA 4000°K
 upon request 3000°K
 Net weight 114gr
 CE IP20

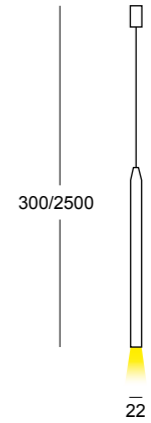

B 151/29
 up to 16 modules
 Net weight 1809gr
 Gross weight 5328gr (with 16 Susp.)
 Volume m³ 0,046
 CE IP20

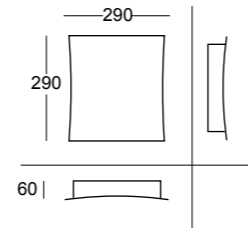

M161 modulo LED
 1x2W LED 700 mA 4000°K
 upon request 3000°K
 Net weight 114gr
 CE IP20

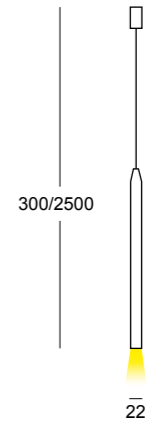

B 151/40
 up to 36 modules
 Net weight 3000gr
 Gross weight 8104gr (with 36 Susp.)
 Volume m³ 0,066
 CE IP20

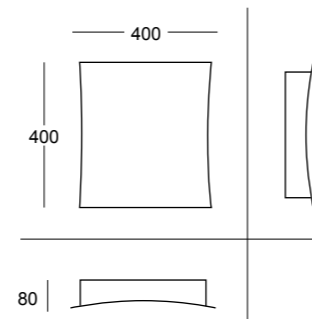

Driver

D151/1 Driver 1/2 LED - Net weight 54gr
 D151/2 Driver 3/8 LED - Net weight 89gr
 D151/3 Driver 9/16 LED - Net weight 223gr

Waterfall lamps

can be customised by combining:
 Base + N°Modules + Power Supply

Cleo

design by C. Cattaneo

La lampada da parete e soffitto Cleo è un'elegante fusione di design contemporaneo e funzionalità sofisticata. Caratterizzata da una lastra di metallo curvata che conferisce un'estetica raffinata, Cleo offre una luce indiretta diffusa, perfetta per creare un'atmosfera accogliente e invitante in qualsiasi ambiente.

Con la sua combinazione di forme eleganti e illuminazione efficiente, Cleo si presenta come un'opzione ideale per chi cerca un'elevata qualità luminosa con un design dal carattere distintivo.

The Cleo wall and ceiling lamp is an elegant fusion of contemporary design and sophisticated functionality. Featuring a curved metal plate that lends a refined aesthetic, Cleo offers diffuse direct light, perfect for creating a welcoming and inviting atmosphere in any room.

With its combination of elegant shapes and efficient lighting, Cleo is an ideal option for those seeking high lighting quality with a distinctive design.

Die Wand - und Deckenleuchte Cleo ist eine elegante Verschmelzung von zeitgenössischem Design und anspruchsvoller Funktionalität. Mit ihrer geschwungenen Metallplatte, die ihr eine raffinierte Ästhetik verleiht, bietet Cleo ein diffuses, indirektes Licht, das perfekt ist, um in jedem Raum eine einladende Atmosphäre zu schaffen.

Mit ihrer Kombination aus eleganten Formen und effizienter Beleuchtung ist Cleo die ideale Wahl für alle, die eine hohe Beleuchtungsqualität und ein unverwechselbares Design suchen.

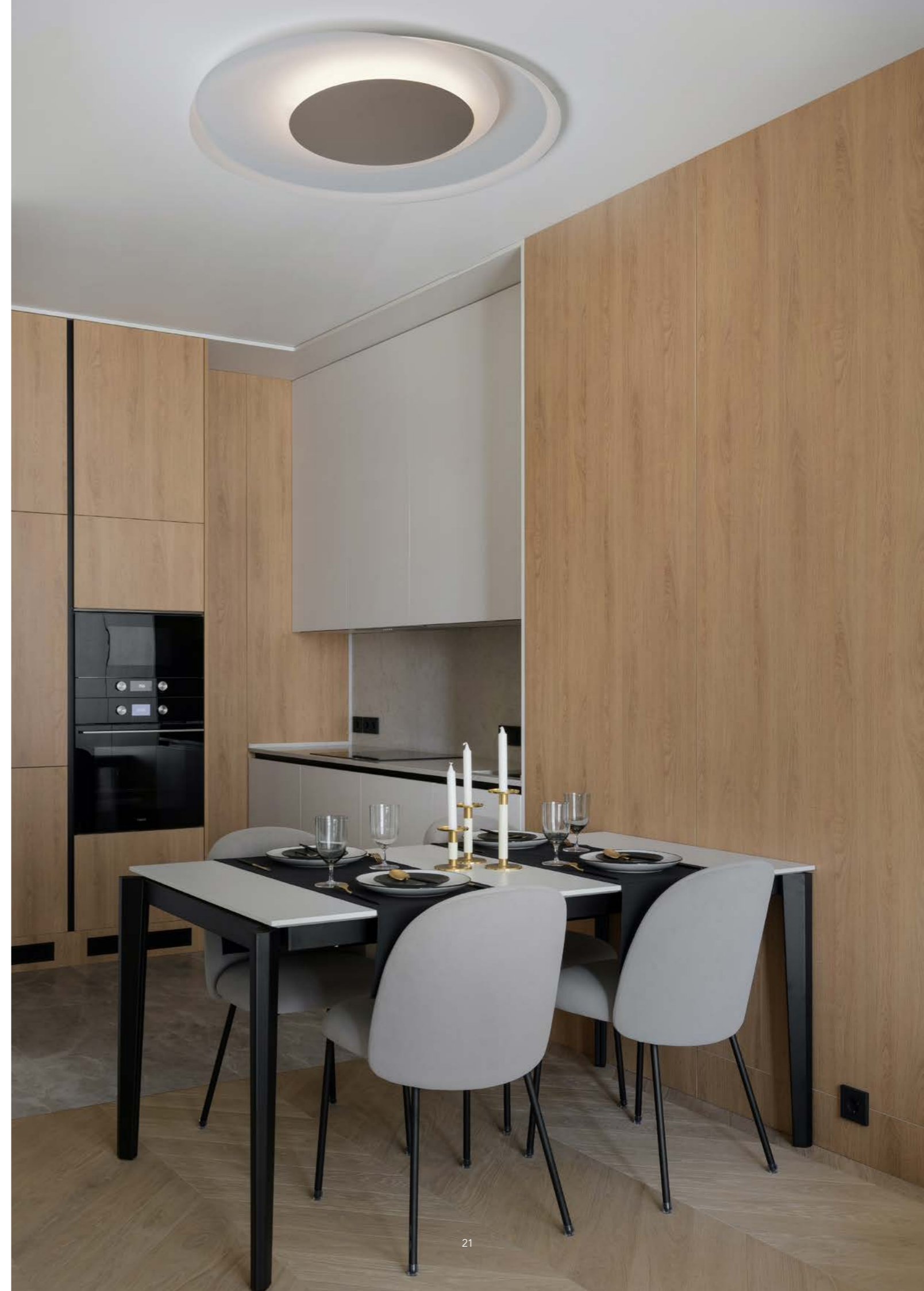



Cleo | Wall - Ceiling

796/50 PA

LED 27W 24V Dc 220 - 240V
2700lm 3000°K upon request 2700°/4000°K
Net weight 4200gr - Gross weight 5400gr
Volume m³ 0.047
CE IP20

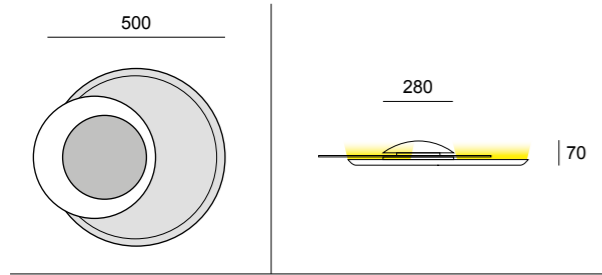

796/60 PA

LED 45W 24V Dc 220 - 240V
4500lm 3000°K upon request 2700°/4000°K
Net weight 4900gr - Gross weight 6100gr
Volume m³ 0.077
CE IP20

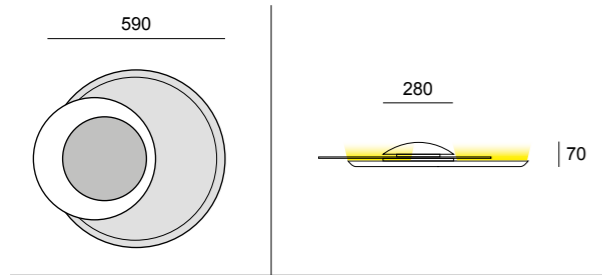

796/80 PA

LED 60W 24V Dc 220 - 240V
6000lm 3000°K upon request 2700°/4000°K
Net weight 6200gr - Gross weight 8000gr
Volume m³ 0.18
CE IP20

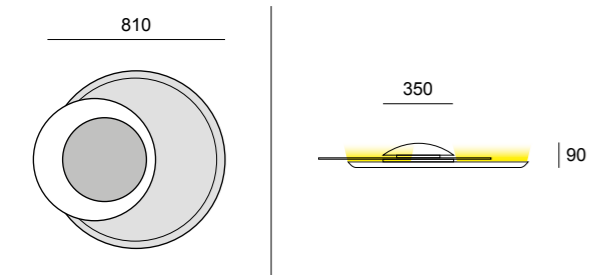

Cleo | Wall - Ceiling

Standard colours

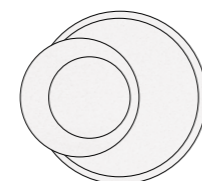

White/White

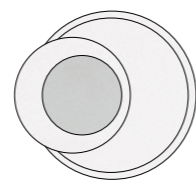

White/Grey

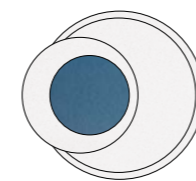

White/Blue

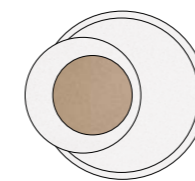

White/Sandy

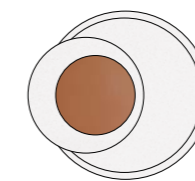

White/Oxide

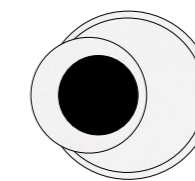

White/Black

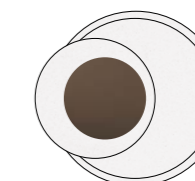

White/Bronze



Cleo | Wall - Ceiling

797/50 PA

LED 27W 24V Dc 220 - 240V
2700lm 3000°K upon request 2700°/4000°K
Net weight 4200gr - Gross weight 5400gr
Volume m³ 0.047
CE IP20

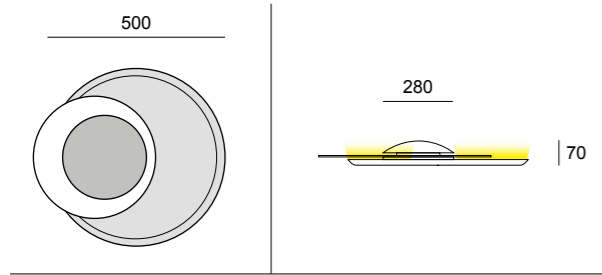

797/60 PA

LED 45W 24V Dc 220 - 240V
4500lm 3000°K upon request 2700°/4000°K
Net weight 4900gr - Gross weight 6100gr
Volume m³ 0.077
CE IP20

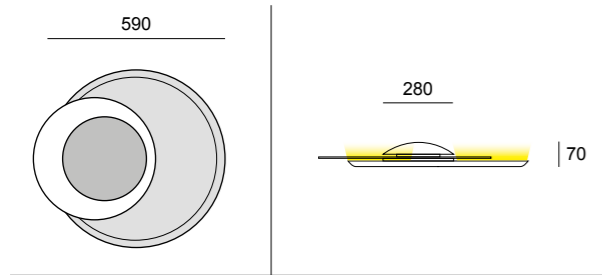

797/80 PA

LED 60W 24V Dc 220 - 240V
6000lm 3000°K upon request 2700°/4000°K
Net weight 6200gr - Gross weight 8000gr
Volume m³ 0.18
CE IP20

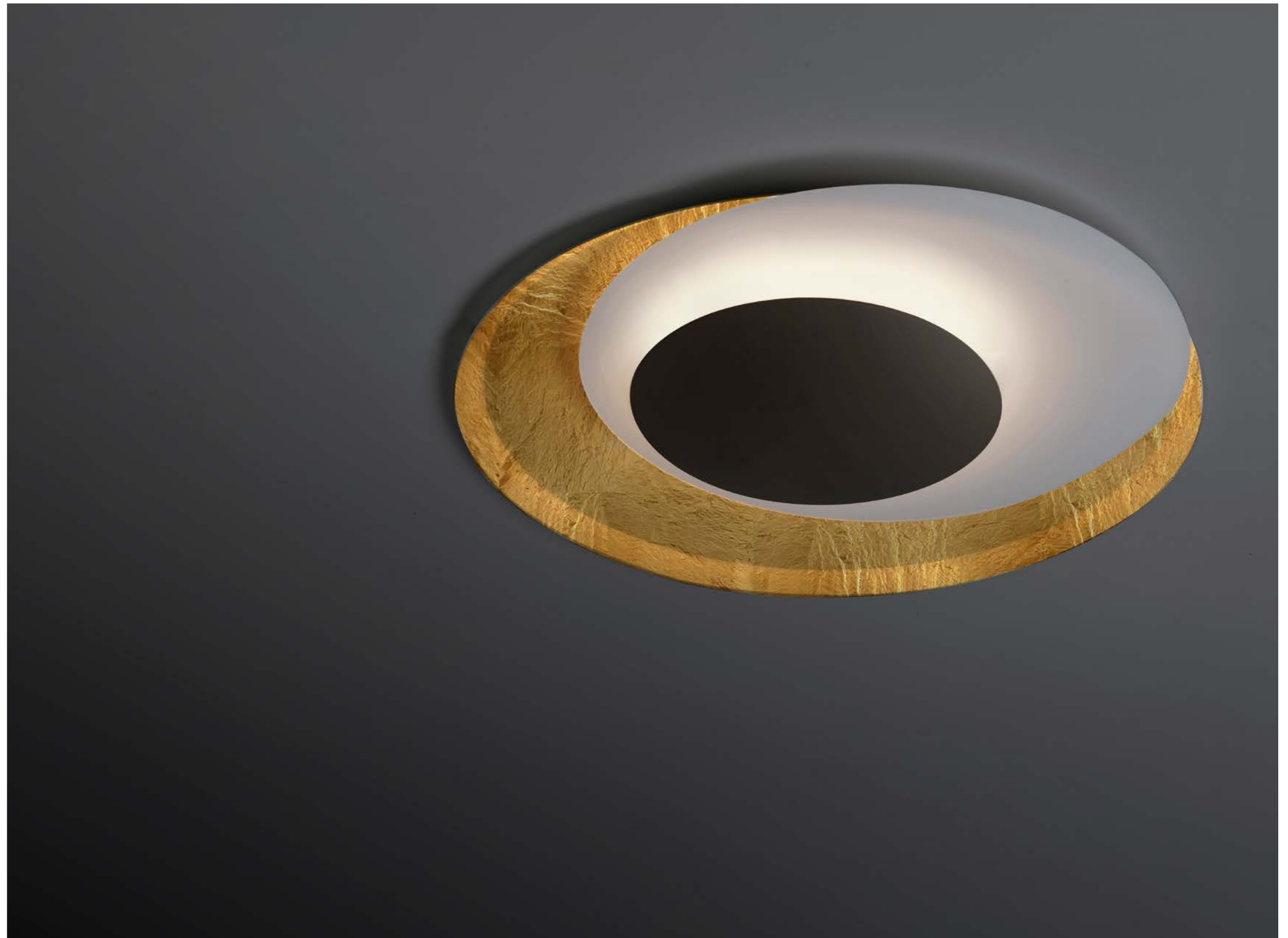
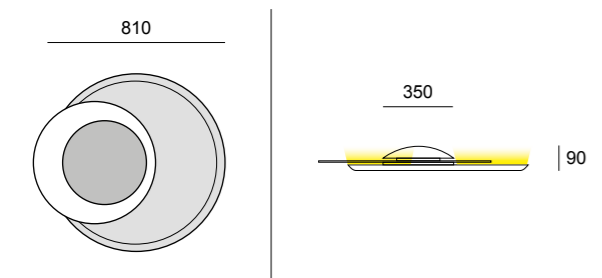

Special colours

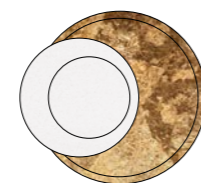

Gold Foil/White

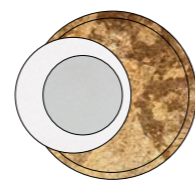

Gold Foil/Grey

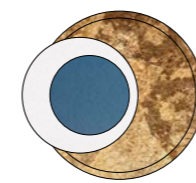

Gold Foil/Blue

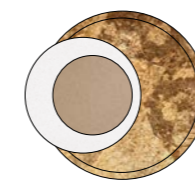

Gold Foil/Sandy

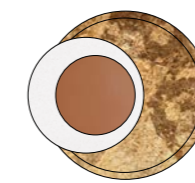

Gold Foil/Oxide

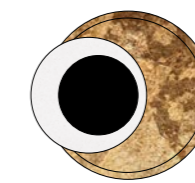

Gold Foil/Black

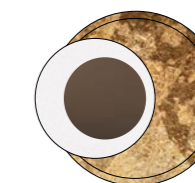

Gold Foil/Bronze

Lunatica

design by C. Cattaneo

La lampada a parete Lunatica si distingue per la sua eleganza e versatilità, offrendo non solo una fonte di luce affidabile ma anche un tocco di bellezza che cattura lo sguardo.

Con la sua forma tonda e la capacità di orientarsi, disponibile in due versioni mono e bi-emissione, la lampada Lunatica si presenta come un gioiello architettonico che illumina con grazia ogni angolo della stanza. La sua costruzione riflette un'armoniosa fusione di forme e funzionalità, offrendo non solo una fonte di luce, ma anche una dichiarazione di stile.

L'estetica minimalista di questa lampada si sposa perfettamente con una varietà di ambienti, dalle moderne residenze urbane alle eleganti dimore di campagna. La sua capacità di orientarsi consente di dirigere la luce esattamente dove è necessaria, offrendo un'illuminazione personalizzata per ogni situazione.

Ma ciò che rende davvero unica la lampada Lunatica è la sua capacità di creare atmosfere suggestive e coinvolgenti. Grazie alla sua forma tonda e alla possibilità di regolare l'intensità luminosa, questa lampada è in grado di trasformare un semplice ambiente in un'esperienza sensoriale.

Per sperimentare appieno tutte le sue caratteristiche e possibilità, basta inquadrare il QR code e lasciarsi guidare attraverso una gamma di movimenti e opzioni di illuminazione che renderanno ogni momento ancora più magico.

The Lunatica wall lamp is distinguished by its elegance and versatility, offering not only a reliable light source but also a touch of beauty that catches the eye.

With its round shape and ability to orient itself, available in two versions, single-emission and bi-emission, the Lunatica lamp presents itself as an architectural jewel that gracefully illuminates every corner of the room. Its construction reflects a harmonious fusion of form and function, offering not only a source of light, but also a style statement.

The minimalist aesthetic of this lamp blends perfectly with a variety of environments, from modern urban residences to elegant country homes. Its ability to orient itself allows light to be directed exactly where it is needed, providing customised lighting for every situation.

But what makes the Lunatica lamp truly unique is its ability to create evocative and engaging atmospheres. Thanks to its round shape and adjustable light intensity, this lamp is able to transform a simple room into a sensory experience.

To fully experience all its features and possibilities, simply frame the QR code and let yourself be guided through a range of movements and lighting options that will make every moment even more magical.

Die Lunatica -Wandleuchte zeichnet sich durch ihre Eleganz und Vielseitigkeit aus und bietet nicht nur eine zuverlässige Lichtquelle, sondern auch einen Hauch von Schönheit, der die Blicke auf sich zieht.

Mit ihrer runden Form und der Fähigkeit, sich selbst auszurichten, die in zwei Versionen erhältlich ist, ein- und zweistrahlig, präsentiert sich die Lunatica Leuchte als architektonisches Juwel, das jede Ecke des Raumes anmutig beleuchtet. Ihre Konstruktion spiegelt eine harmonische Verschmelzung von Form und Funktion wider und bietet nicht nur eine Lichtquelle, sondern auch ein Stilmerkmal.

Die minimalistische Ästhetik dieser Leuchte passt perfekt zu einer Vielzahl von Umgebungen, von modernen Stadtresidenzen bis zu eleganten Landhäusern. Ihre Fähigkeit, sich selbst auszurichten, ermöglicht es, das Licht genau dorthin zu lenken, wo es benötigt wird, und bietet so eine maßgeschneiderte Beleuchtung für jede Situation.

Was die Lunatica -Leuchte jedoch wirklich einzigartig macht, ist ihre Fähigkeit, stimmungsvolle und einnehmende Atmosphären zu schaffen. Dank ihrer runden Form und der einstellbaren Lichtintensität kann diese Leuchte einen einfachen Raum in ein sinnliches Erlebnis verwandeln.

Um all ihre Funktionen und Möglichkeiten zu erleben, müssen Sie nur den QR-Code eingeben und sich durch eine Reihe von Bewegungen und Beleuchtungsoptionen führen lassen, die jeden Moment noch magischer machen.



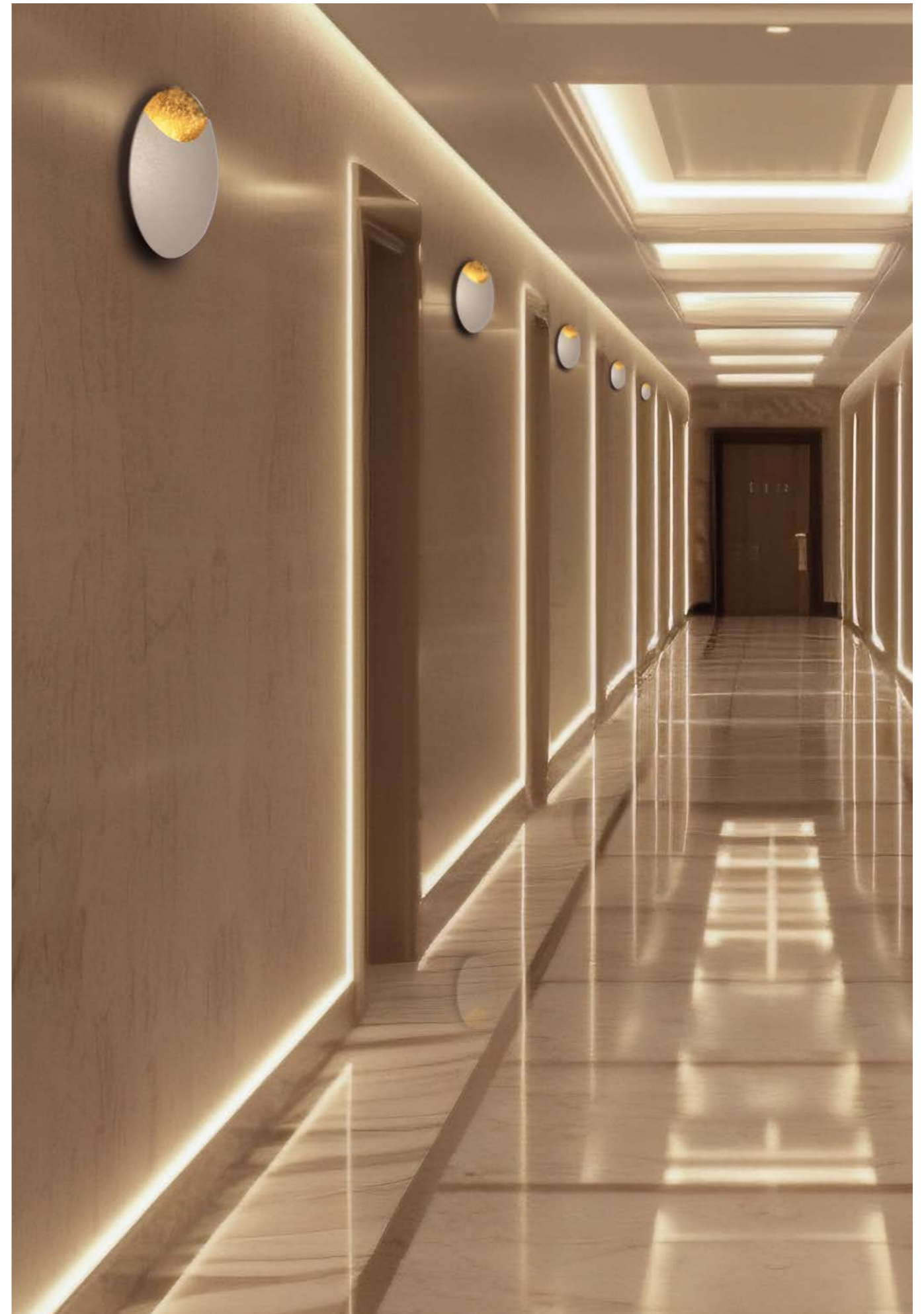

794/28 A

LED 12W 24V Dc 220 - 240V
2000lm 3000°K upon request 2700°/4000°K
Net weight 1400gr - Gross weight 3300gr
Volume m³ 0.02

CE IP20

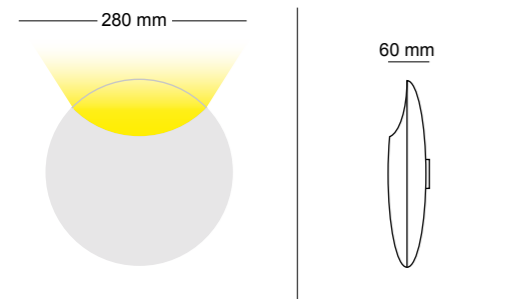

794/20 A

LED 4W 24V Dc 220 - 240V
550lm 3000°K upon request 2700°/4000°K
Net weight 600gr - Gross weight 1600gr
Volume m³ 0.096

CE IP20

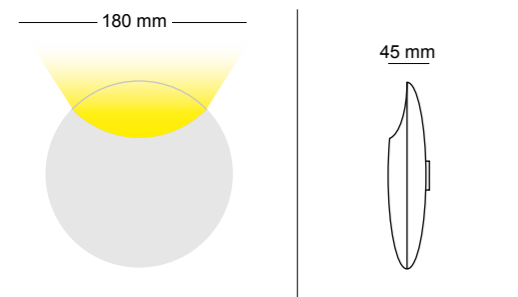

795/28 A

LED 2x12W 24V Dc 220 - 240V
4000lm 3000°K upon request 2700°/4000°K
Net weight 1300gr - Gross weight 3200gr
Volume m³ 0.02

CE IP20

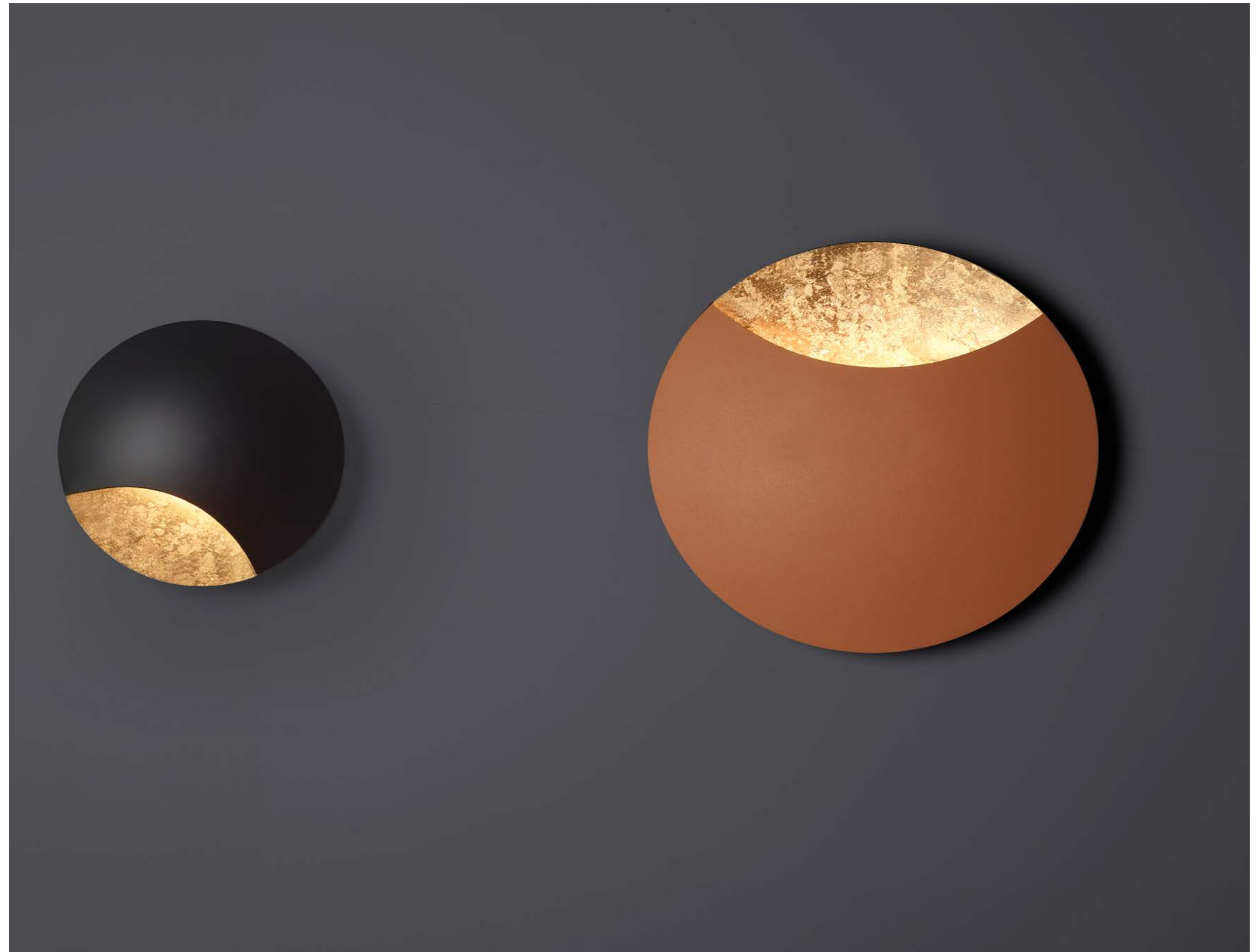
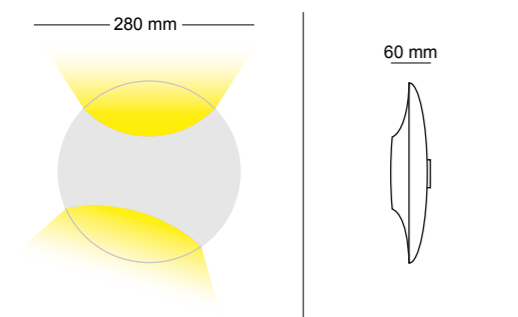

Guarda il video
Watch the video
Video ansehen



Special colours

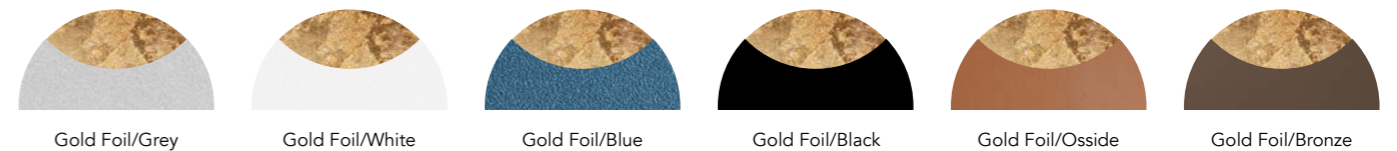



792/28 A

LED 12W 24V Dc 220 - 240V
2000lm 3000°K upon request 2700°/4000°K
Net weight 1400gr - Gross weight 3300gr
Volume m³ 0.02
CE IP20

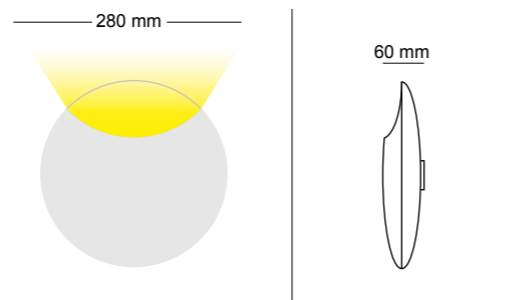

792/20 A

LED 4W 24V Dc 220 - 240V
550lm 3000°K upon request 2700°/4000°K
Net weight 600gr - Gross weight 1600gr
Volume m³ 0.096
CE IP20

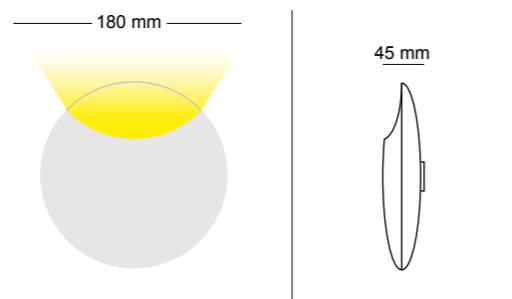

793/28 A

LED 2x 12W 24V Dc 220 - 240V
4000lm 3000°K upon request 2700°/4000°K
Net weight 1300gr - Gross weight 3200gr
Volume m³ 0.02
CE IP20

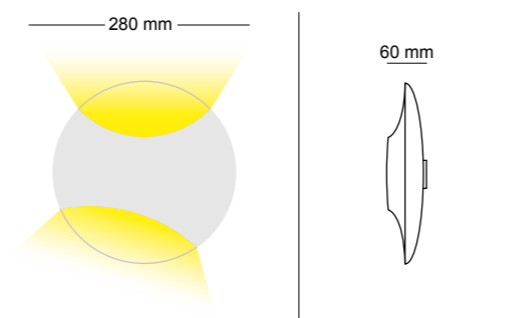

Standard colours

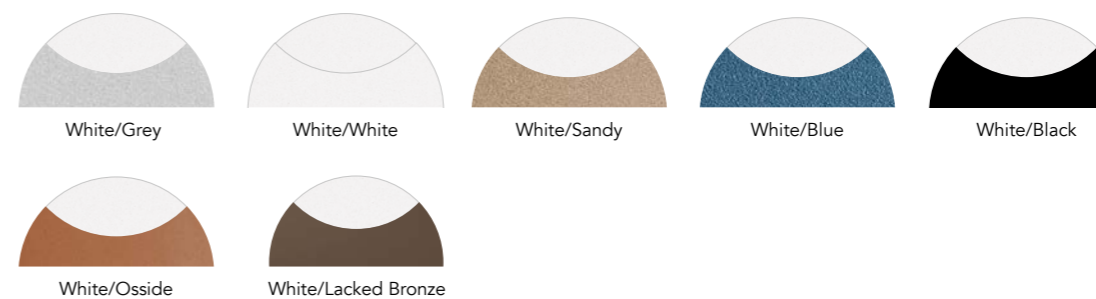

Orione

design by C. Cattaneo

“Orione”, un’eccellenza nel mondo dell’illuminazione decorativa moderna. Questa straordinaria lampada rappresenta l’apice della versatilità, portando una luce incantevole e un design sofisticato sia al soffitto che alle pareti.

La “Orione” è molto più di una semplice lampada; è un’opera d’arte illuminante in grado di trasformare gli ambienti con eleganza e stile. La sua natura polifunzionale consente di utilizzarla sia come plafone che come applique da parete, adattandosi perfettamente alle esigenze e all’arredamento di ogni spazio.

Un’ulteriore distintiva di questa straordinaria serie è la possibilità di personalizzare il look con diverse finiture mixabili tra il corpo della lampada e il diffusore. Con una vasta gamma di opzioni disponibili, potrete creare combinazioni uniche che riflettono il vostro gusto personale e lo stile del vostro ambiente.

Grazie alla nuova scheda LED ultra piatta, la “Orione” offre una luce intensa e uniforme, con un’illusione magica di dove si trova la sorgente luminosa. Questa caratteristica conferisce alla lampada un tocco di mistero e poesia, creando un’atmosfera incantevole e suggestiva.

Scoprite la bellezza e l’innovazione della serie “Orione” di Cattaneo Illuminazione e lasciatevi affascinare dalla sua capacità di aggiungere un tocco di eleganza e calore a ogni ambiente.

“Orione”, an excellence in the world of modern decorative lighting. This extraordinary lamp represents the epitome of versatility, bringing enchanting light and sophisticated design to both ceilings and walls.

The “Orione” is much more than a simple lamp; it is an illuminating work of art capable of transforming spaces with elegance and style. Its multifunctional nature allows it to be used as both a ceiling lamp and a wall sconce, perfectly adapting to the needs and decor of any space.

Another distinctive feature of this exceptional series is the possibility to customize the look with different finishes that can be mixed between the lamp body and the diffuser. With a wide range of available options, you can create unique combinations that reflect your personal taste and the style of your environment.

Thanks to the new ultra-thin LED board, the “Orione” provides intense and uniform light, with a magical illusion of where the light source is located. This characteristic gives the lamp a touch of mystery and poetry, creating a charming and evocative atmosphere.

Discover the beauty and innovation of the “Orione” series by Cattaneo Illuminazione and be captivated by its ability to add a touch of elegance and warmth to any environment.

“Orione”, eine Exzellenz in der Welt der modernen dekorativen Beleuchtung. Diese außergewöhnliche Lampe repräsentiert die Spitze der Vielseitigkeit und bringt bezauberndes Licht und anspruchsvolles Design sowohl an die Decke als auch an die Wände.

Die “Orione” ist weit mehr als nur eine einfache Lampe; sie ist ein leuchtendes Kunstwerk, das in der Lage ist, Räume mit Eleganz und Stil zu verwandeln. Ihre multifunktionale Natur ermöglicht es, sie sowohl als Deckenlampe als auch als Wandleuchte zu verwenden und sich perfekt an die Bedürfnisse und das Dekor jedes Raums anzupassen.

Ein weiteres markantes Merkmal dieser außergewöhnlichen Serie ist die Möglichkeit, das Aussehen mit verschiedenen Oberflächen zu personalisieren, die zwischen dem Lampenkörper und dem Diffusor kombiniert werden können. Mit einer breiten Palette von verfügbaren Optionen können Sie einzigartige Kombinationen erstellen, die Ihren persönlichen Geschmack und den Stil Ihrer Umgebung widerspiegeln.

Dank des neuen ultraflachen LED-Boards bietet die “Orione” ein intensives und gleichmäßiges Licht mit einer magischen Illusion, wo sich die Lichtquelle befindet. Diese Eigenschaft verleiht der Lampe einen Hauch von Geheimnis und Poesie und schafft eine charmante und evokative Atmosphäre.

Entdecken Sie die Schönheit und Innovation der “Orione” Serie von Cattaneo Illuminazione und lassen Sie sich von ihrer Fähigkeit begeistern, jedem Raum eine Note von Eleganz und Wärme zu verleihen.

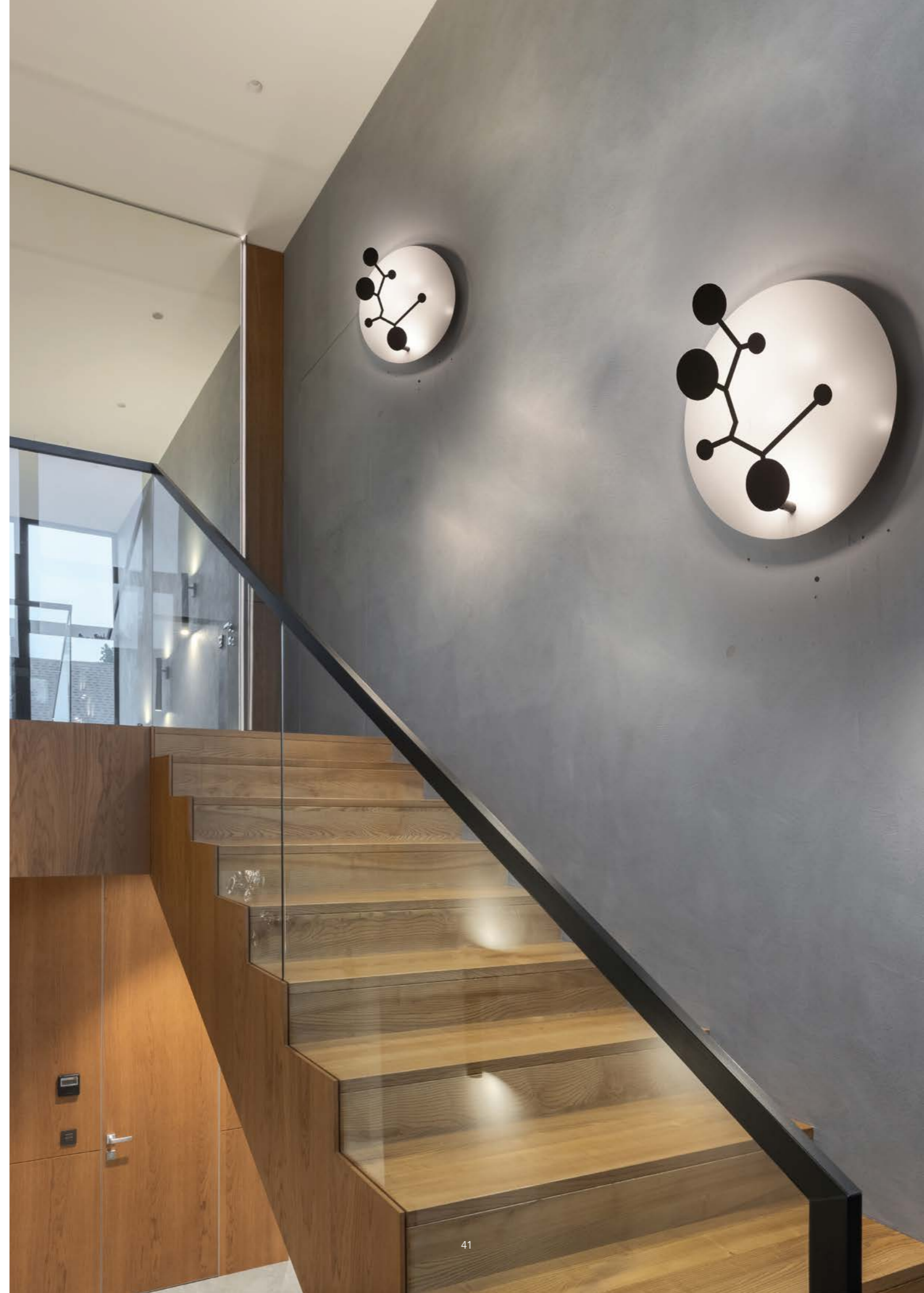

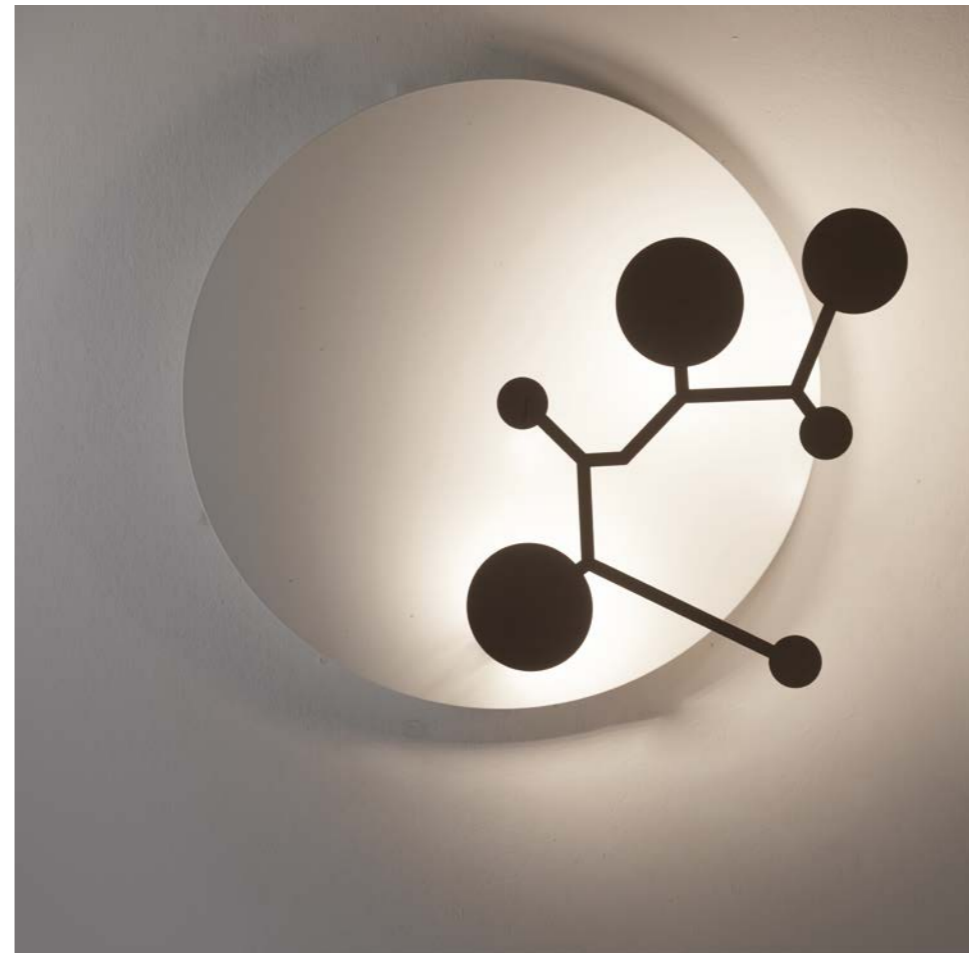
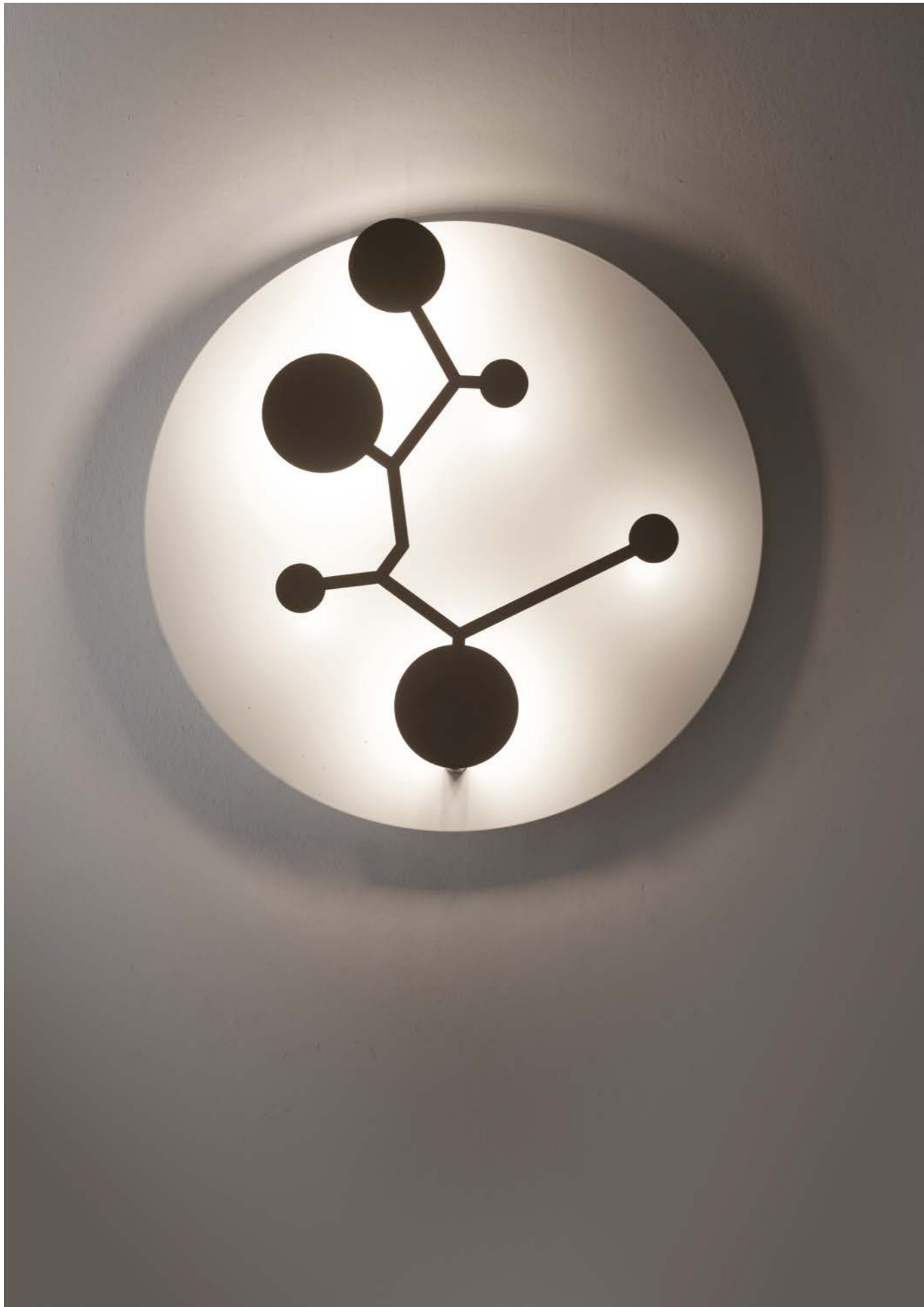

921/40 PA

LED 19W 24V Dc 220 - 240V
2800lm 3000°K upon request 2700°/4000°K
Net weight 2660gr - Gross weight 3900gr
Volume m³ 0.031

 with leading edge or trailing edge

CE  IP20

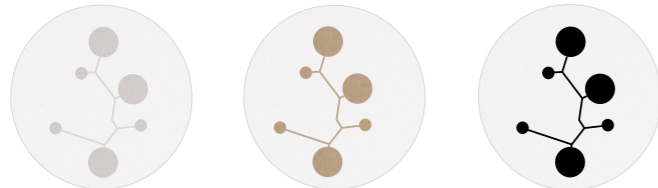

White / White

White / Sandy

White / Matt Black

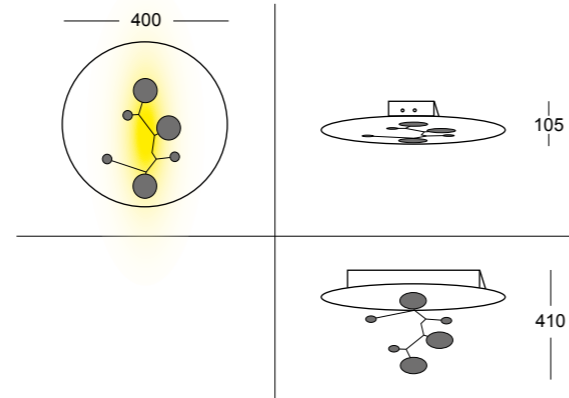

921/60 PA

LED 2x19W 24V Dc 220 - 240V
5600lm 3000°K upon request 2700°/4000°K
Net weight 5400gr - Gross weight 7000gr
Volume m³ 0.090

 with leading edge or trailing edge

CE  IP20

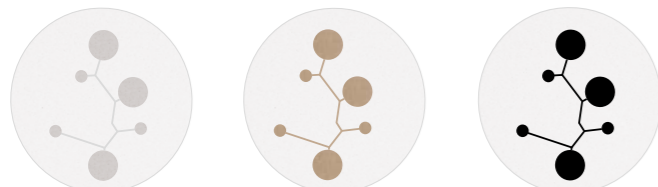

White / White

White / Sandy

White / Matt Black

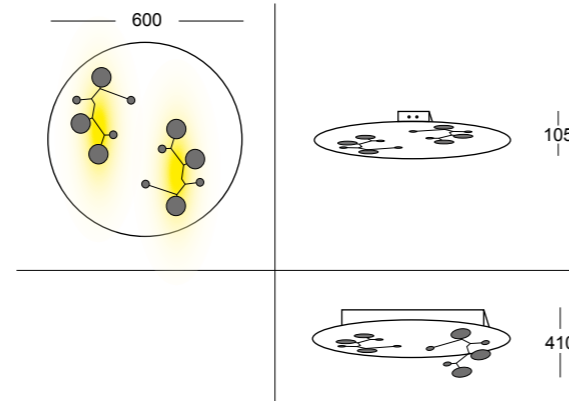

921/80 PA

LED 3x19W 24V Dc 220 - 240V
8400lm 3000°K upon request 2700°/4000°K
Net weight 8800gr - Gross weight 11400gr
Volume m³ 0.170

 with leading edge or trailing edge

CE  IP20

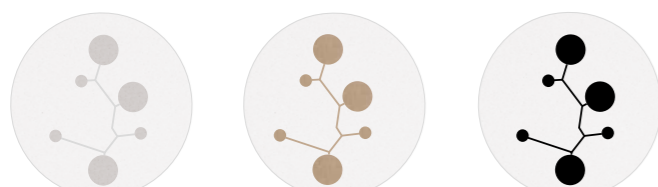

White / White

White / Sandy

White / Matt Black

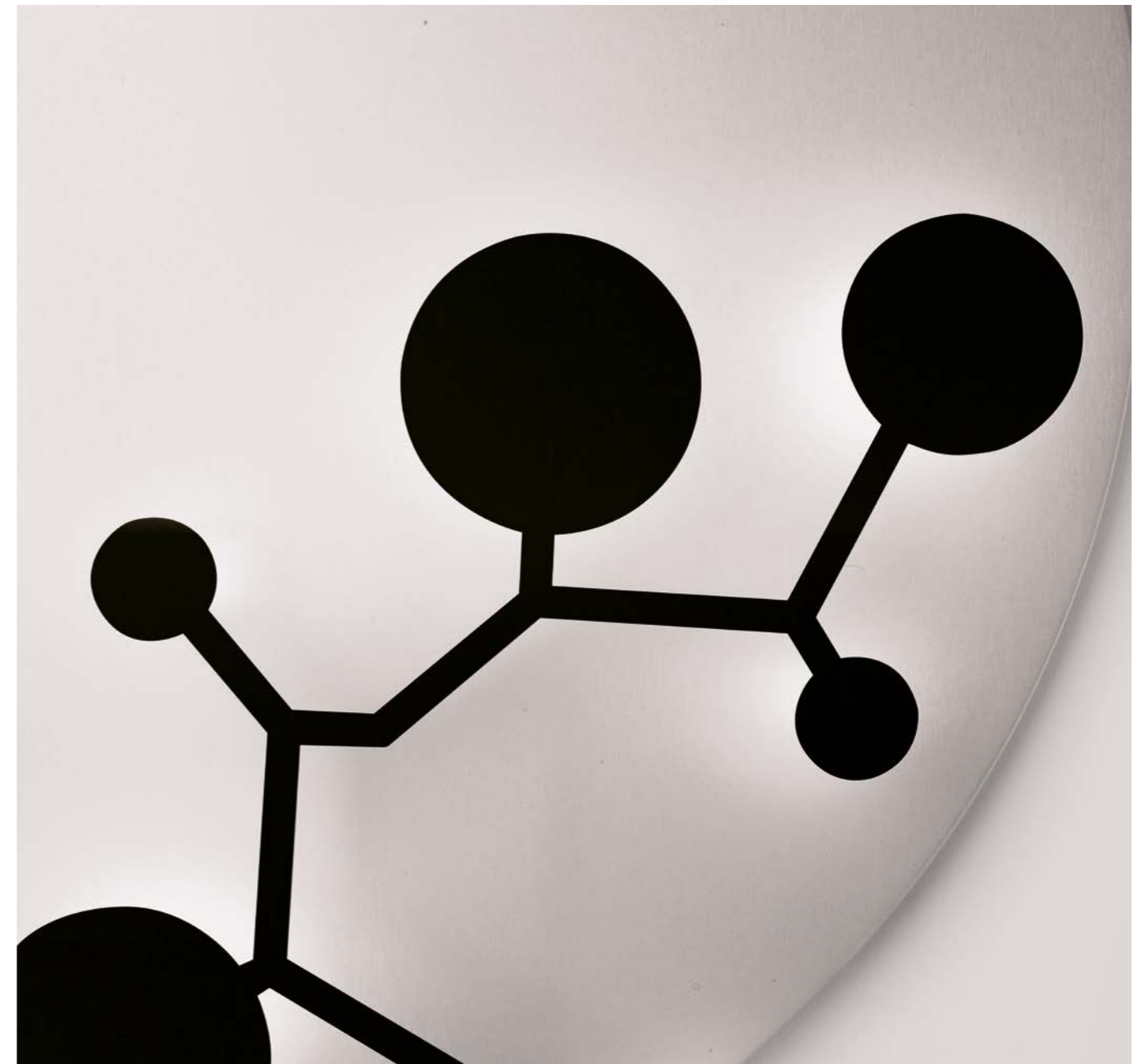
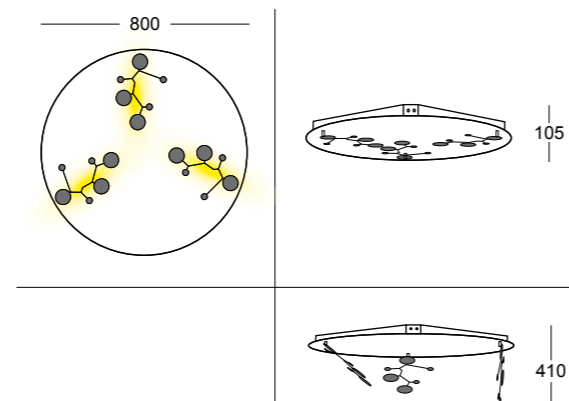

Orione | Wall - Ceiling

922/40 PA

LED 19W 24V Dc 220 - 240V
2800lm 3000°K upon request 2700°/4000°K
Net weight 2660gr - Gross weight 3900gr
Volume m³ 0.031

 with leading edge or trailing edge

CE  IP20

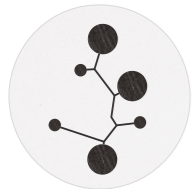

White / Bronze

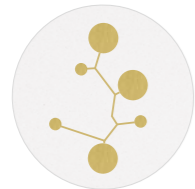

White / Plated Gold

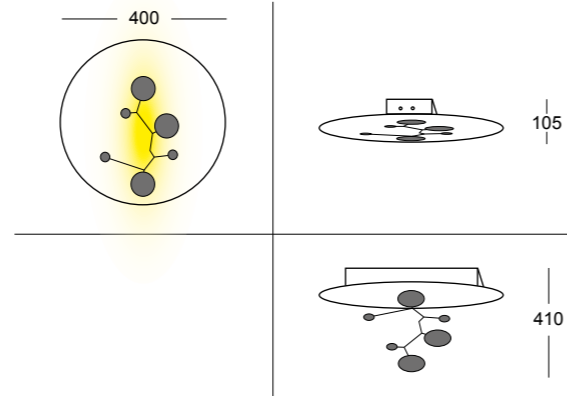

922/60 PA

LED 2x19W 24V Dc 220 - 240V
5600lm 3000°K upon request 2700°/4000°K
Net weight 5400gr - Gross weight 7000gr
Volume m³ 0.090

 with leading edge or trailing edge

CE  IP20

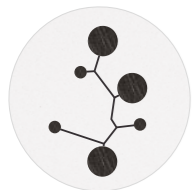

White / Bronze

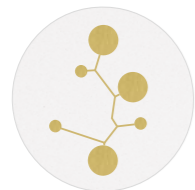

White / Plated Gold

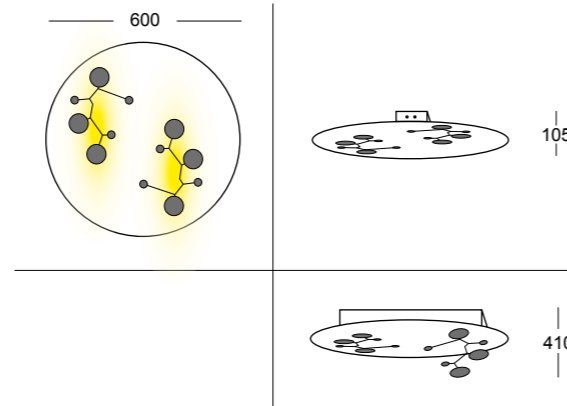

922/80 PA

LED 3x19W 24V Dc 220 - 240V
8400lm 3000°K upon request 2700°/4000°K
Net weight 8800gr - Gross weight 11400gr
Volume m³ 0.170

 with leading edge or trailing edge

CE  IP20

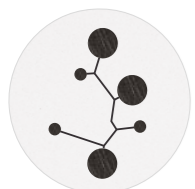

White / Bronze

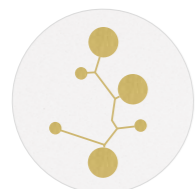

White / Plated Gold

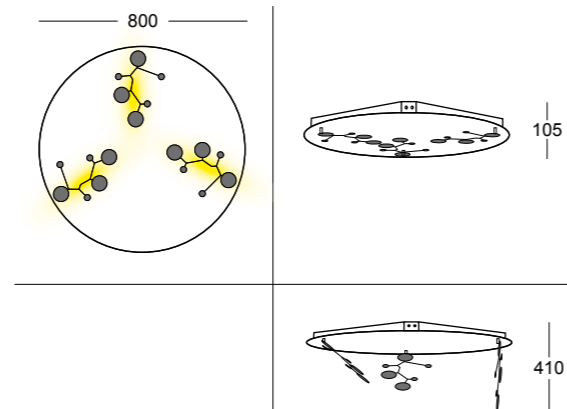

Orione | Wall - Ceiling

923/40 PA

LED 19W 24V Dc 220 - 240V
2800lm 3000°K upon request 2700°/4000°K
Net weight 2660gr - Gross weight 3900gr
Volume m³ 0.031

 with leading edge or trailing edge

CE  IP20

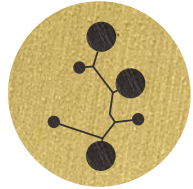

Plated Gold / Bronze

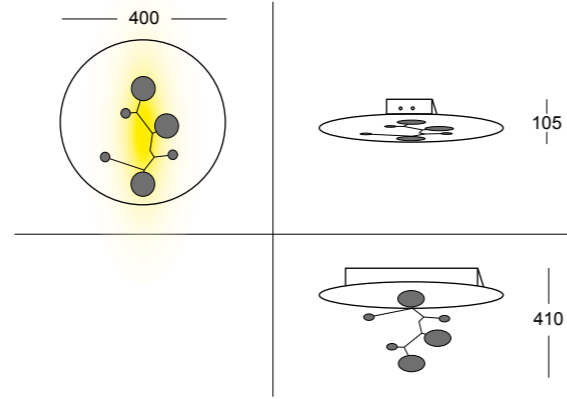

923/60 PA

LED 2x19W 24V Dc 220 - 240V
5600lm 3000°K upon request 2700°/4000°K
Net weight 5400gr - Gross weight 7000gr
Volume m³ 0.090

 with leading edge or trailing edge

CE  IP20

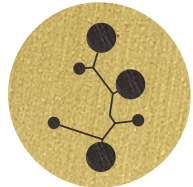

Plated Gold / Bronze

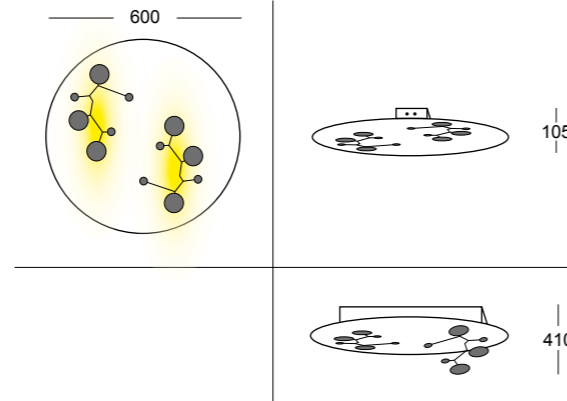

923/80 PA

LED 3x19W 24V Dc 220 - 240V
8400lm 3000°K upon request 2700°/4000°K
Net weight 8800gr - Gross weight 11400gr
Volume m³ 0.170

 with leading edge or trailing edge

CE  IP20

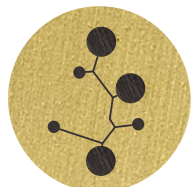

Plated Gold / Bronze

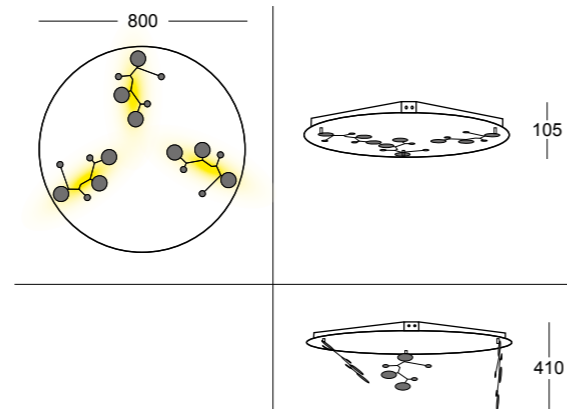

Orione | Wall - Ceiling

924/40 PA

LED 19W 24V Dc 220 - 240V
2800lm 3000°K upon request 2700°/4000°K
Net weight 2660gr - Gross weight 3900gr
Volume m³ 0.031

 with leading edge or trailing edge

CE  IP20

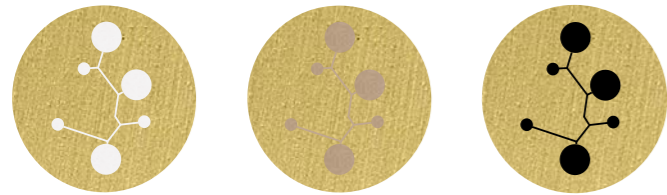

Plated Gold / White Plated Gold / Sandy Plated Gold / Matt Black

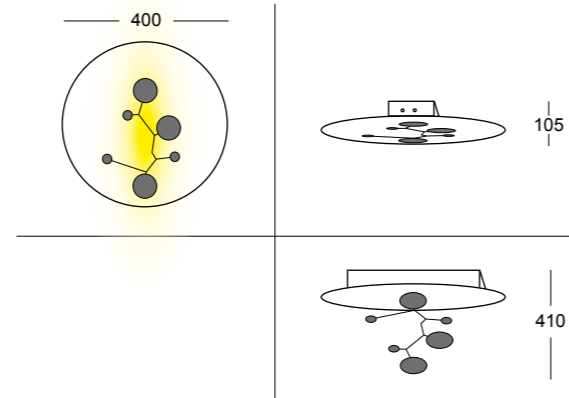

924/60 PA

LED 2x19W 24V Dc 220 - 240V
5600lm 3000°K upon request 2700°/4000°K
Net weight 5400gr - Gross weight 7000gr
Volume m³ 0.090

 with leading edge or trailing edge

CE  IP20

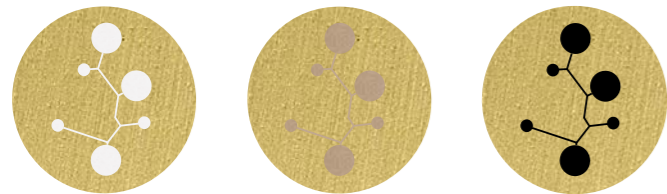

Plated Gold / White Plated Gold / Sandy Plated Gold / Matt Black

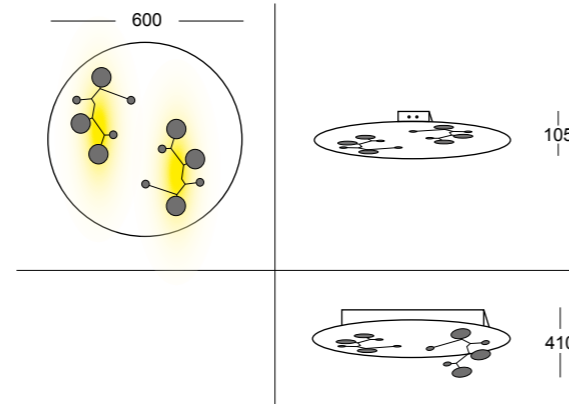

924/80 PA

LED 3x19W 24V Dc 220 - 240V
8400lm 3000°K upon request 2700°/4000°K
Net weight 8800gr - Gross weight 11400gr
Volume m³ 0.170

 with leading edge or trailing edge

CE  IP20

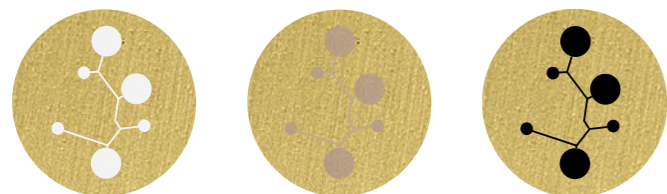

Plated Gold / White Plated Gold / Sandy Plated Gold / Matt Black

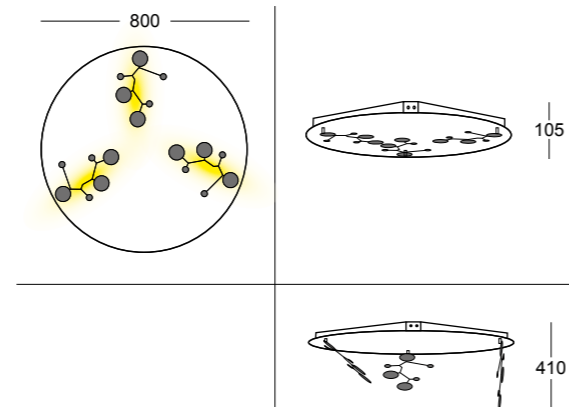

Orione | Wall - Ceiling



La scheda con piste integrate per evitare cavi a vista ed i led protetti da una speciale vernice permettono al diffusore uno spessore minimo.

The board with integrated tracks to avoid visible wires and the LEDs protected by a special paint allow the diffuser a minimum thickness.

Die Platine mit integrierten Schienen, um sichtbare Kabel zu vermeiden, und die LEDs, die durch eine spezielle Farbe geschützt sind, erlauben dem Diffusor eine minimale Dicke



Innesto tramite sistema jack per un montaggio più semplice.

Plug-in via jack system for easier mounting

Plug-in über Buchsensystem für einfachere Montage



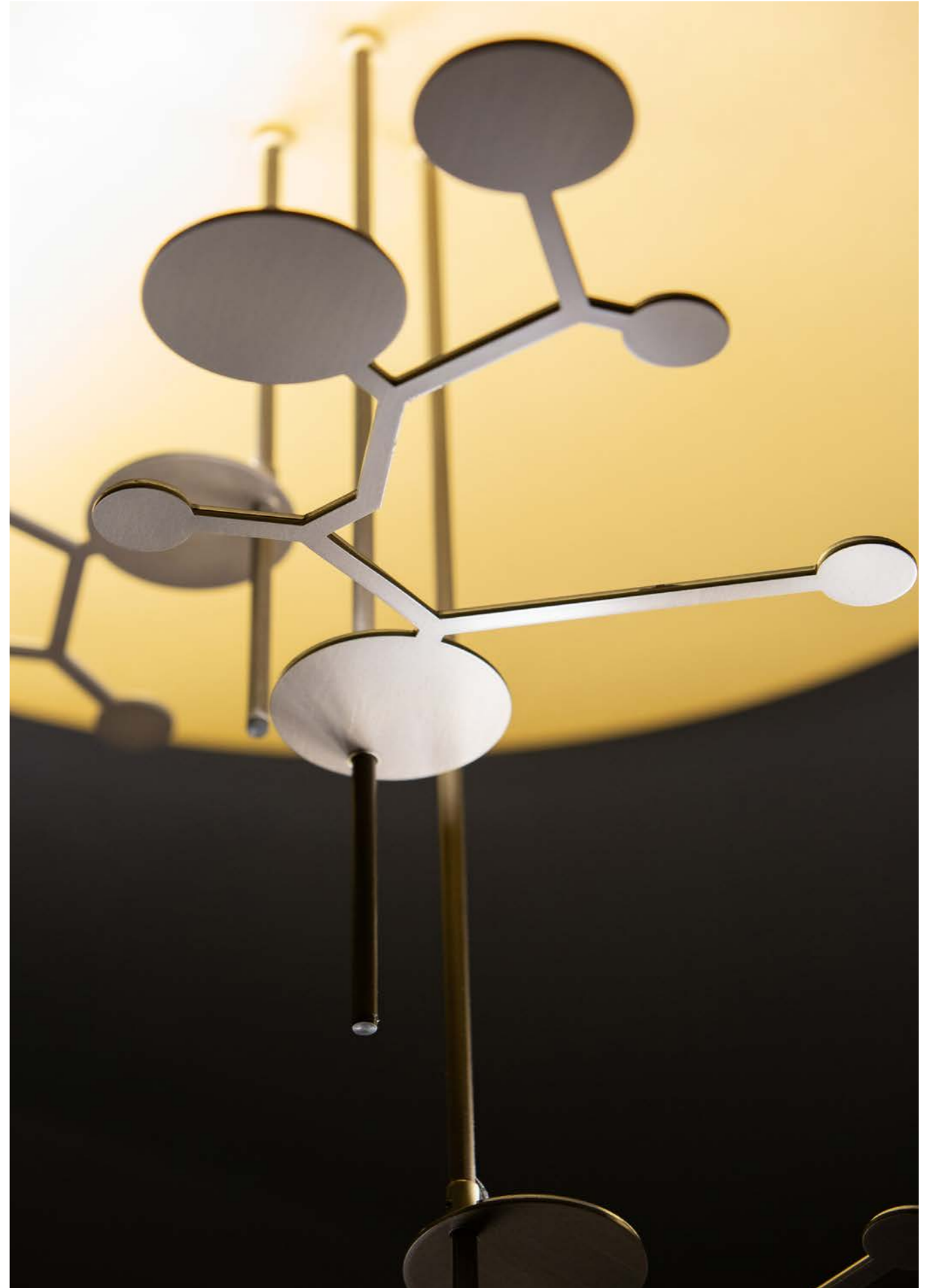



934/70 SP

LED 2x19W 24V Dc 220 - 240V
5600lm 3000°K upon request 2700°/4000°K
Net weight 7700gr - Gross weight 10050gr
Volume m³ 0.118

☰ with leading edge or trailing edge

Dimmable
CE IP20

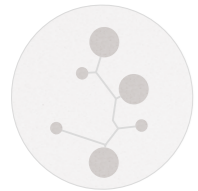

White / White

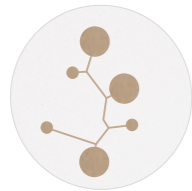

White / Sandy

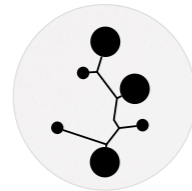

White / Matt Black

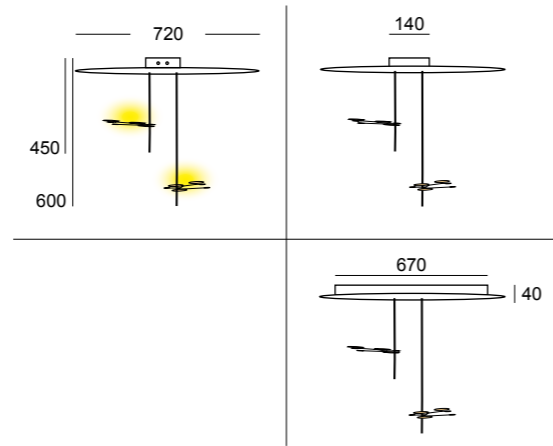

934/80 SP

LED 3x19W 24V Dc 220 - 240V
8400lm 3000°K upon request 2700°/4000°K
Net weight 8800gr - Gross weight 11400gr
Volume m³ 0.195

☰ with leading edge or trailing edge

Dimmable
CE IP20

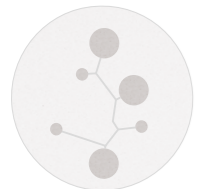

White / White

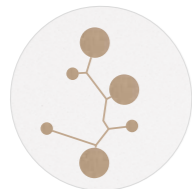

White / Sandy

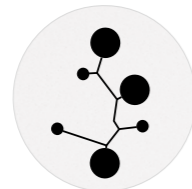

White / Matt Black

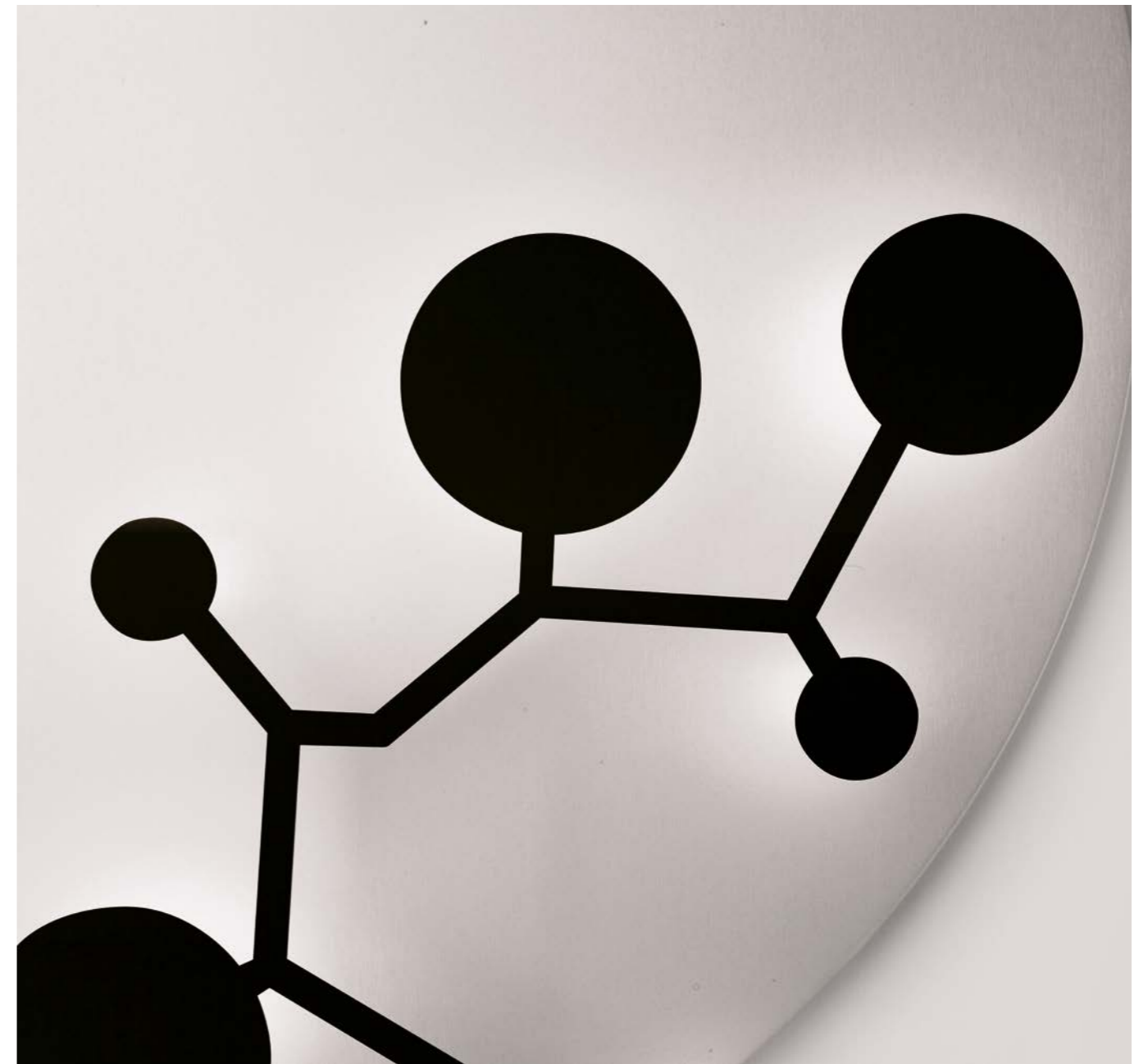
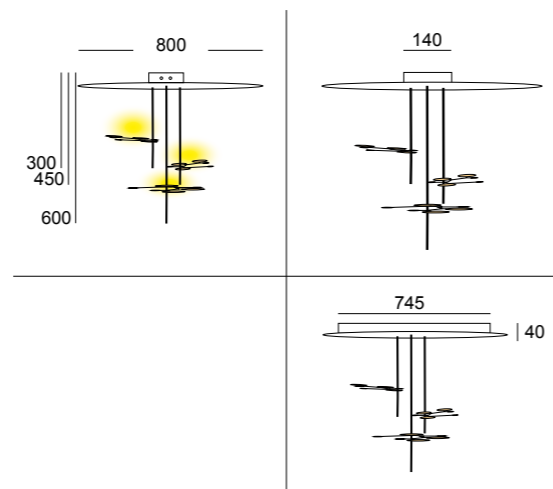

Orione | Wall - Ceiling

935/70 SP

LED 2x19W 24V Dc 220 - 240V
5600lm 3000°K upon request 2700°/4000°K
Net weight 7700gr - Gross weight 10050gr
Volume m³ 0.118

☰ with leading edge or trailing edge

Dimmable
CE IP20

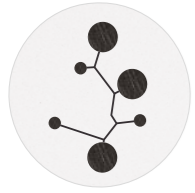

White / Bronze

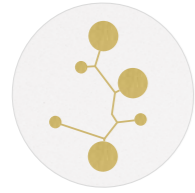

White / Plated Gold

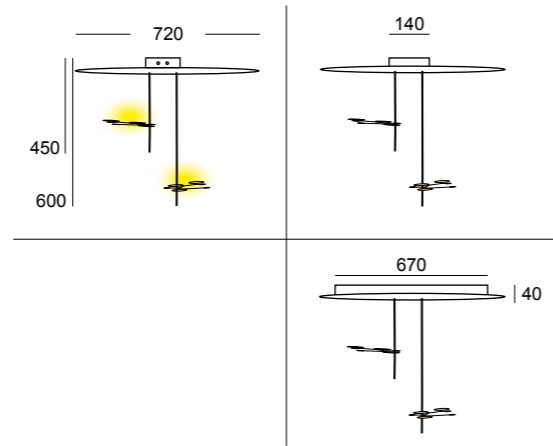

935/80 SP

LED 3x19W 24V Dc 220 - 240V
8400lm 3000°K upon request 2700°/4000°K
Net weight 8800gr - Gross weight 11400gr
Volume m³ 0.195

☰ with leading edge or trailing edge

Dimmable
CE IP20

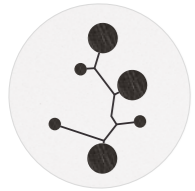

White / Bronze

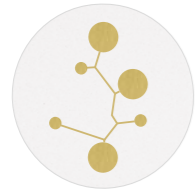

White / Plated Gold

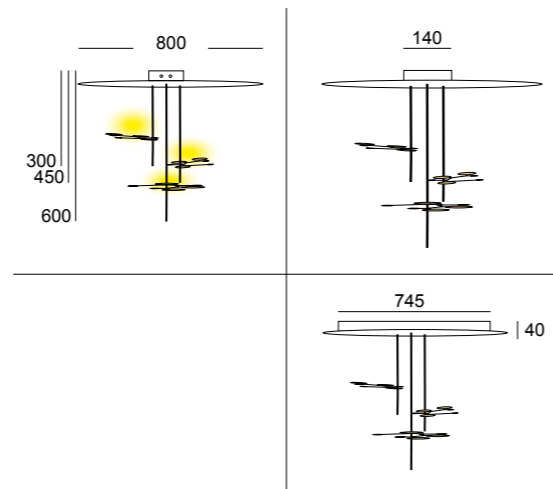

Orione | Wall - Ceiling

936/70 SP

LED 2x19W 24V Dc 220 - 240V
5600lm 3000°K upon request 2700°/4000°K
Net weight 7700gr - Gross weight 10050gr
Volume m³ 0.118

☯ with leading edge or trailing edge

Dimmable
CE IP20

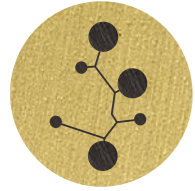

Plated Gold / Bronze

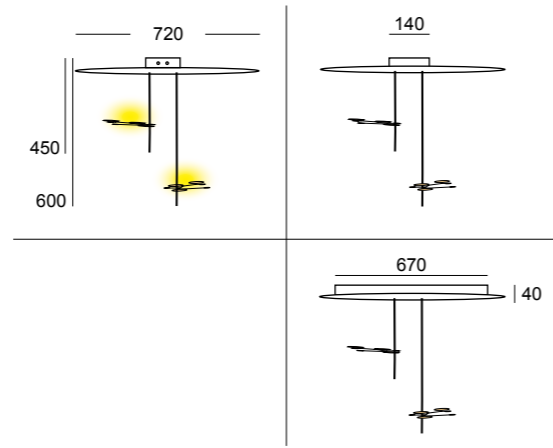

936/80 SP

LED 3x19W 24V Dc 220 - 240V
8400lm 3000°K upon request 2700°/4000°K
Net weight 8800gr - Gross weight 11400gr
Volume m³ 0.195

☯ with leading edge or trailing edge

Dimmable
CE IP20

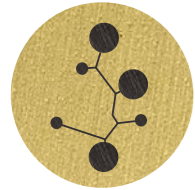

Plated Gold / Bronze

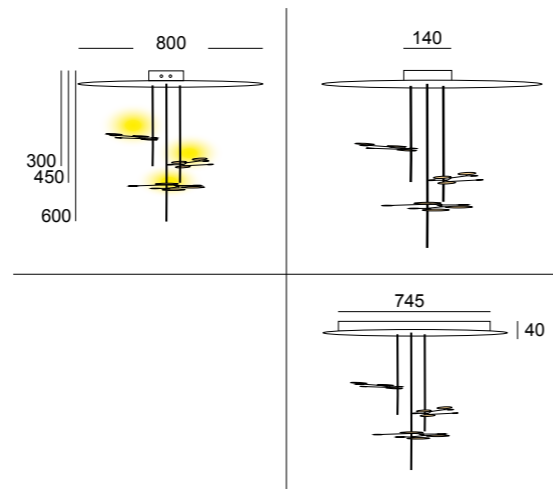

Orione | Wall - Ceiling

937/70 SP

LED 2x19W 24V Dc 220 - 240V
5600lm 3000°K upon request 2700°/4000°K
Net weight 7700gr - Gross weight 10050gr
Volume m³ 0.118

☰ with leading edge or trailing edge

Dimmable
CE IP20



Plated Gold / White

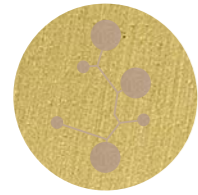

Plated Gold / Sandy

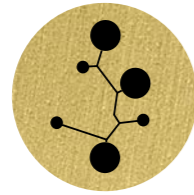

Plated Gold / Matt Black

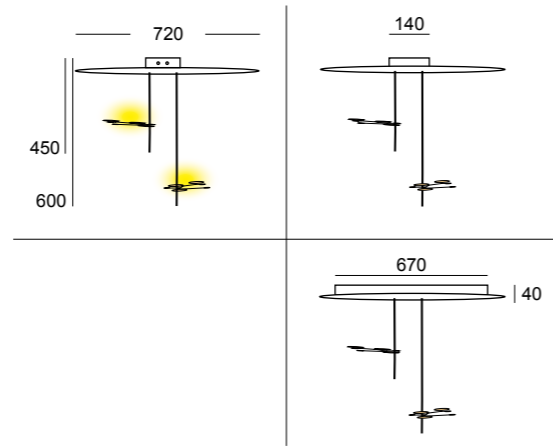

937/80 SP

LED 3x19W 24V Dc 220 - 240V
8400lm 3000°K upon request 2700°/4000°K
Net weight 8800gr - Gross weight 11400gr
Volume m³ 0.195

☰ with leading edge or trailing edge

Dimmable
CE IP20



Plated Gold / White

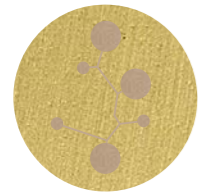

Plated Gold / Sandy

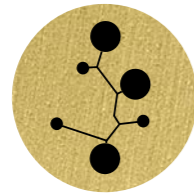

Plated Gold / Matt Black

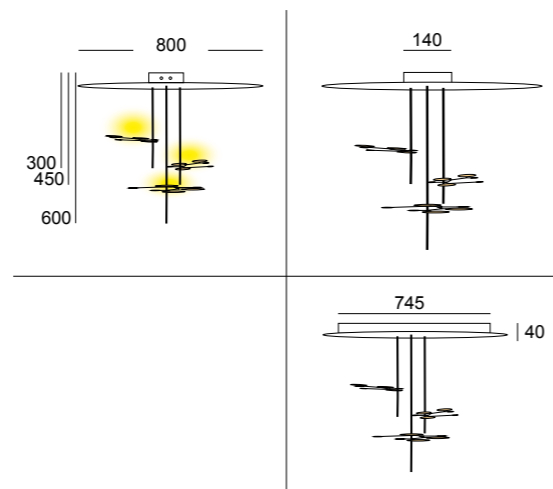

Orione | Wall - Ceiling

Logica Logica up&down

design by C. Cattaneo

Un esclusivo pezzo di design italiano che unisce eleganza e funzionalità in modo unico. Questa lampada rappresenta l'armonia tra la forma e la funzione, offrendo una soluzione illuminante versatile e innovativa per gli ambienti domestici e professionali.

La caratteristica distintiva di Logica è il suo sistema unico di regolazione dell'intensità luminosa. Grazie alla presenza di un proxy dimmer sia nella parte superiore che in quella inferiore del prodotto, è possibile controllare la quantità di luce emessa in modo semplice e intuitivo. Questo permette di adattare l'atmosfera luminosa alle diverse esigenze e occasioni, creando sempre l'ambiente ideale.

La lampada è realizzata con una struttura di alluminio fresato, un materiale che garantisce robustezza e resistenza nel tempo. La possibilità di scegliere tra diverse finiture, incluso oro e bronzo, consente di personalizzare la lampada per abbinarsi perfettamente a qualsiasi stile d'arredamento.

Logica è molto più di una semplice fonte di luce; è un elemento di design raffinato che aggiunge un tocco di classe e originalità ad ogni ambiente. Scoprite di più su questa straordinaria lampada da sospensione e lasciatevi ispirare dalle sue caratteristiche innovative.

An exclusive piece of Italian design that combines elegance and functionality in a unique way. This lamp represents the harmony between form and function, offering a versatile and innovative lighting solution for both residential and professional spaces.

The distinctive feature of "Logica" is its unique brightness adjustment system. With a proxy dimmer located at both the top and bottom of the product, controlling the amount of emitted light becomes simple and intuitive. This allows you to adapt the lighting atmosphere to different needs and occasions, always creating the ideal environment.

The lamp is crafted with a milled aluminum structure, a material that ensures durability and resistance over time. The option to choose from various finishes, including gold and bronze, allows you to personalize the lamp to perfectly match any interior style.

"Logica" is much more than just a simple light source; it is a refined design element that adds a touch of class and originality to any space. Discover more about this extraordinary pendant light and be inspired by its innovative features.

Ein exklusives Stück italienischen Designs, das Eleganz und Funktionalität auf einzigartige Weise vereint. Diese Lampe repräsentiert die Harmonie von Form und Funktion und bietet eine vielseitige und innovative Beleuchtungslösung für Wohn- und Geschäftsräume.

Das herausragende Merkmal von "Logica" ist sein einzigartiges Helligkeitsregulierungssystem. Mit einem Proxy-Dimmer sowohl oben als auch unten am Produkt wird die Steuerung der abgegebenen Lichtmenge einfach und intuitiv. Dadurch können Sie die Beleuchtungsatmosphäre an verschiedene Bedürfnisse und Anlässe anpassen und immer die ideale Umgebung schaffen.

Die Lampe besteht aus einer gefrästen Aluminiumstruktur, einem Material, das Robustheit und Beständigkeit im Laufe der Zeit gewährleistet. Die Möglichkeit, aus verschiedenen Oberflächen, einschließlich Gold und Bronze, zu wählen, ermöglicht es Ihnen, die Lampe individuell an jeden Einrichtungsstil anzupassen.

"Logica" ist weit mehr als nur eine einfache Lichtquelle; es ist ein raffiniertes Designelement, das jedem Raum eine Note von Klasse und Originalität verleiht. Entdecken Sie mehr über diese außergewöhnliche Pendelleuchte und lassen Sie sich von ihren innovativen Eigenschaften inspirieren.



lampada | sospensione

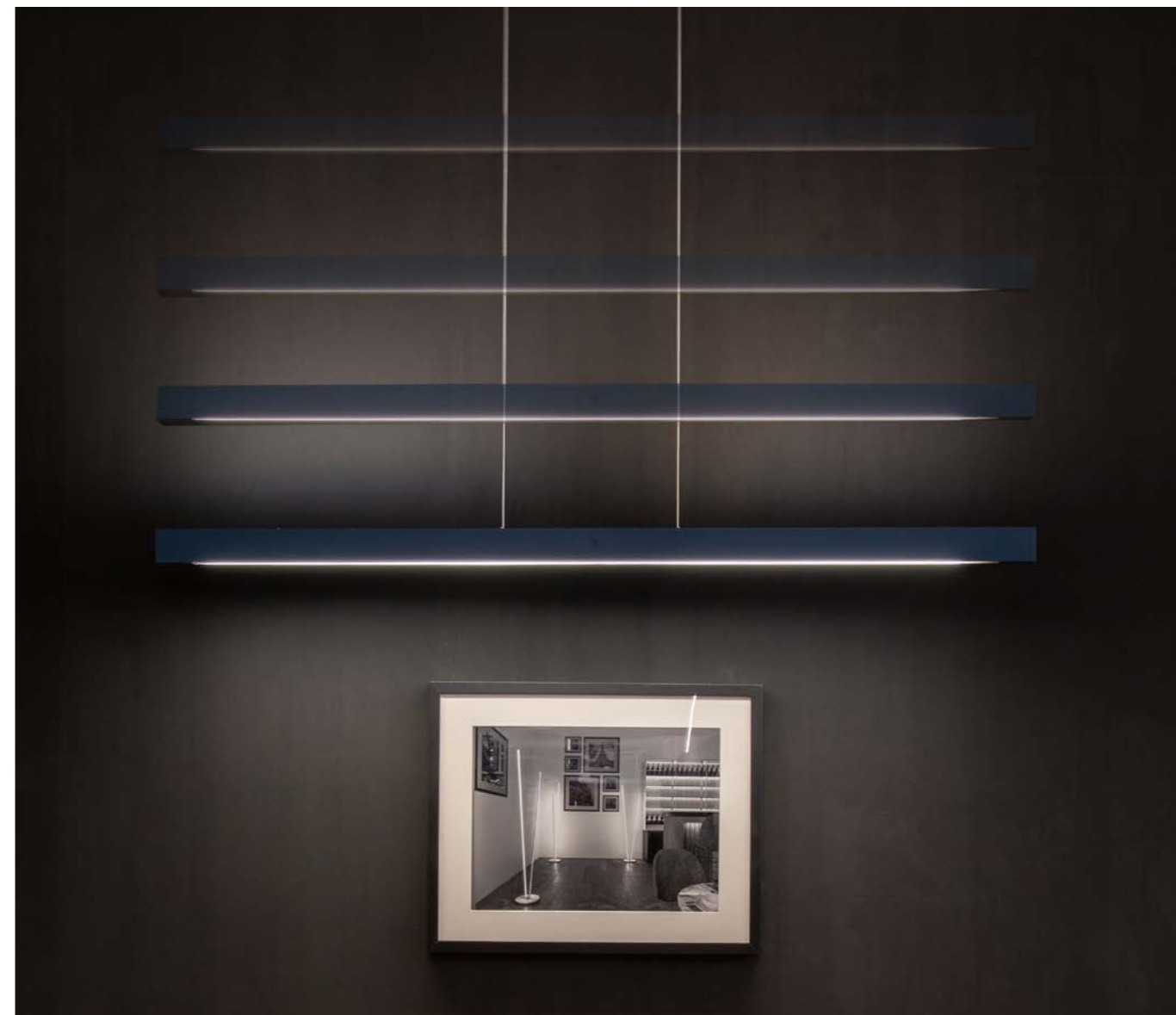

Guarda il video
Watch the video
Video ansehen

Logica è una lampada biemissione con proxy dimmer, che ti permette di gestire la luce diretta e indiretta con dimmer indipendenti. Avrai il controllo completo dell'atmosfera luminosa nella tua casa, creando l'ambiente perfetto per ogni occasione. Inoltre il nuovo sistema di saliscendi con escursione di 1 metro, ti permette di regolarla a tuo piacimento a seconda delle occasioni nella versione Logica up&down.

Logica is a bi-emission lamp with proxy dimmer, allowing you to manage direct and indirect light with independent dimmers. You will have complete control of the lighting atmosphere in your home, creating the perfect ambience for every occasion. In addition, the new up-and-down system with 1 metre excursion allows you to adjust it to your needs according to the occasion in the Logica up&down version.

Logica ist eine Lampe mit Bi-Emission und Proxi-Dimmer, die es Ihnen ermöglicht, direktes und indirektes Licht mit unabhängigen Dimmern zu steuern. So haben Sie die vollständige Kontrolle über die Lichtatmosphäre in Ihrem Zuhause und schaffen das perfekte Ambiente für jede Gelegenheit. Darüber hinaus ermöglicht das neue Up-and-Down-System mit 1 Meter Ausladung in der Logica Up&Down-Version, die Leuchte je nach Anlass nach Belieben einzustellen.

Up&down version

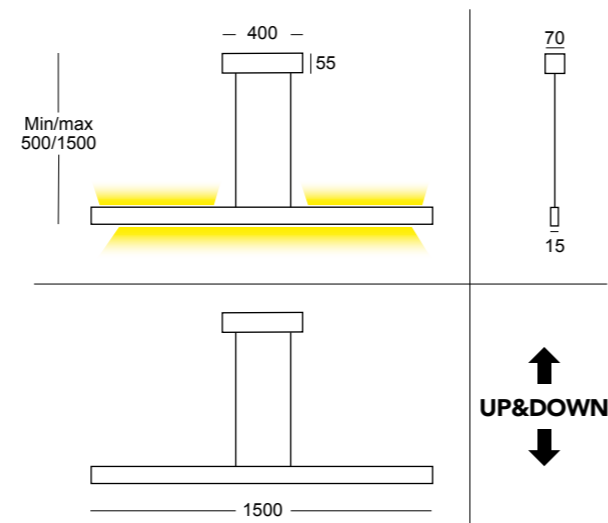
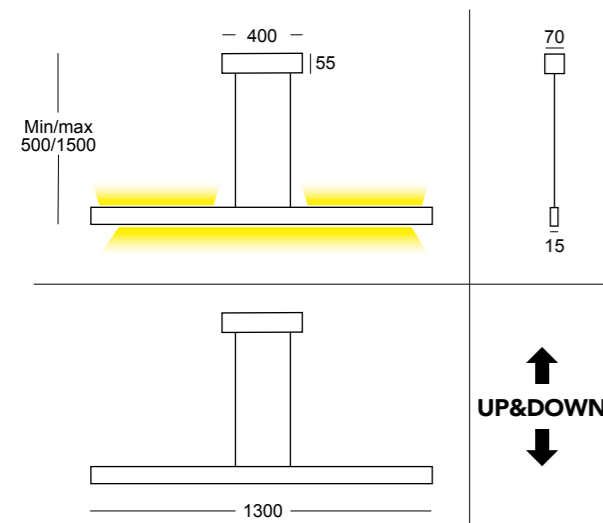

927/130 S

LED 55W 24V Dc 220 - 240V
6100lm 3000°K upon request 2700°/4000°K
Net weight 3700gr - Gross weight 7000gr
volume m³ 0.052

with proxi dimmer

CE IP20

927/150 S

LED 67W 24V Dc 220 - 240V
7400lm 3000°K upon request 2700°/4000°K
Net weight 4100gr - Gross weight 7500gr
volume m³ 0.033

with proxi dimmer

CE IP20

Static version

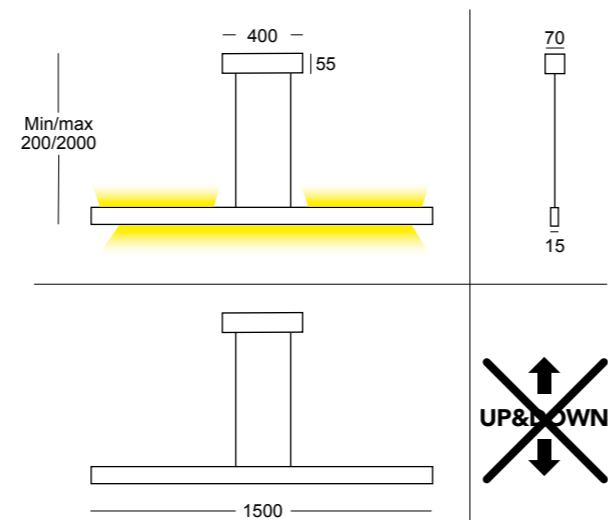
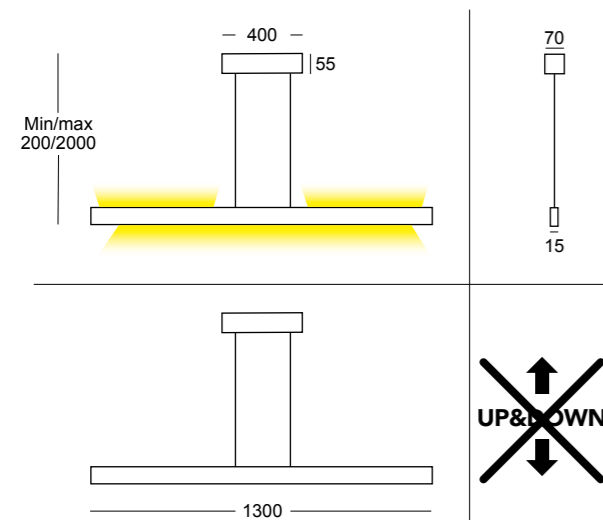

928/130 S

LED 55W 24V Dc 220 - 240V
6100lm 3000°K upon request 2700°/4000°K
Net weight 3700gr - Gross weight 7000gr
volume m³ 0.052

with leading edge or trailing edge

CE IP20

928/150 S

LED 67W 24V Dc 220 - 240V
7400lm 3000°K upon request 2700°/4000°K
Net weight 4100gr - Gross weight 7500gr
volume m³ 0.033

with leading edge or trailing edge

CE IP20



Special colours

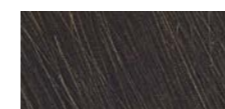

Bronze



Plated Gold

Up&down version

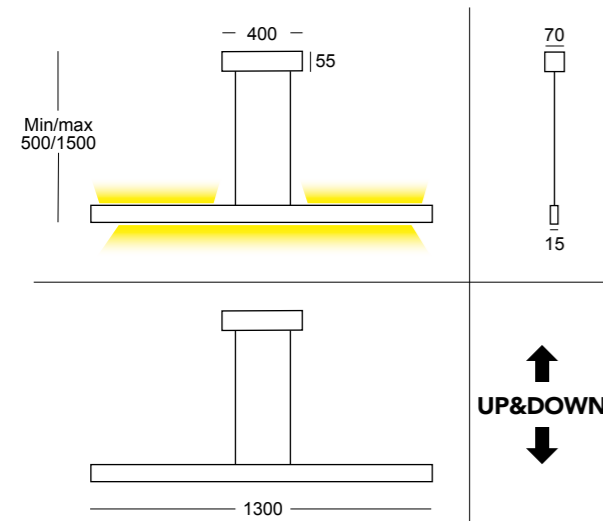

925/130 S

LED 55W 24V Dc 220 - 240V
 6100lm 3000°K upon request 2700°/4000°K
 Net weight 3700gr - Gross weight 7000gr
 volume m³ 0.052

with proxi dimmer

CE IP20

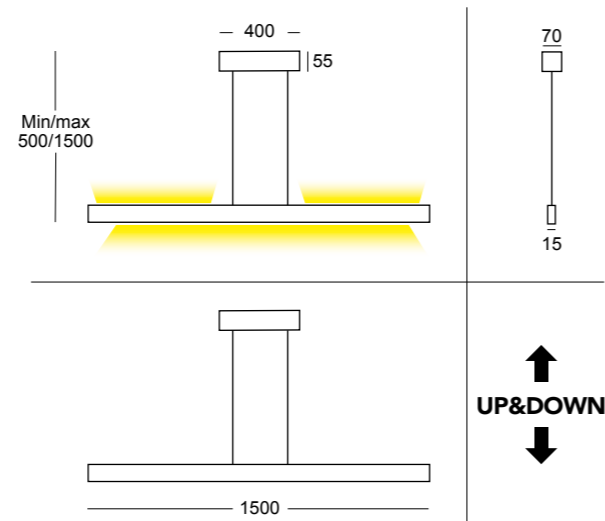

925/150 S

LED 67W 24V Dc 220 - 240V
 7400lm 3000°K upon request 2700°/4000°K
 Net weight 4100gr - Gross weight 7500gr
 volume m³ 0.033

with proxi dimmer

CE IP20

Static version

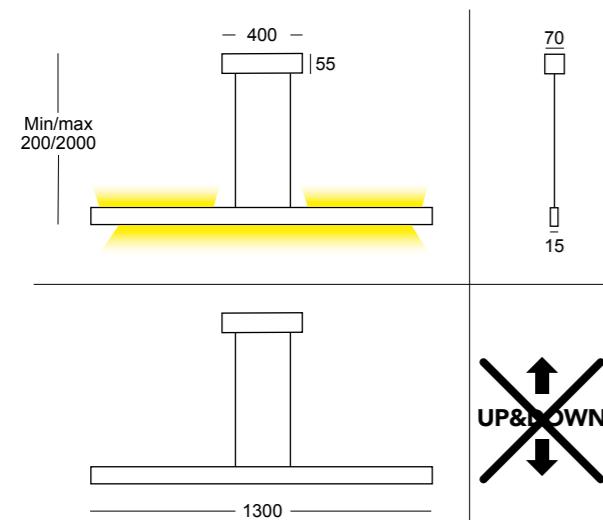

926/130 S

LED 55W 24V Dc 220 - 240V
 6100lm 3000°K upon request 2700°/4000°K
 Net weight 3700gr - Gross weight 7000gr
 volume m³ 0.052

with leading edge or trailing edge

CE IP20

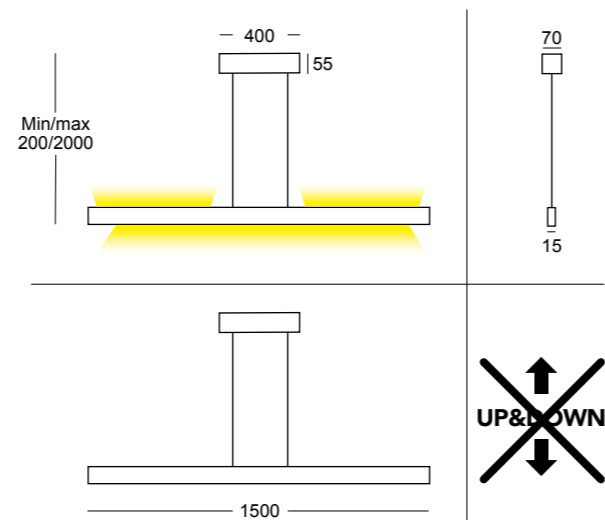

926/150 S

LED 67W 24V Dc 220 - 240V
 7400lm 3000°K upon request 2700°/4000°K
 Net weight 4100gr - Gross weight 7500gr
 volume m³ 0.033

with leading edge or trailing edge

CE IP20



Standard colours

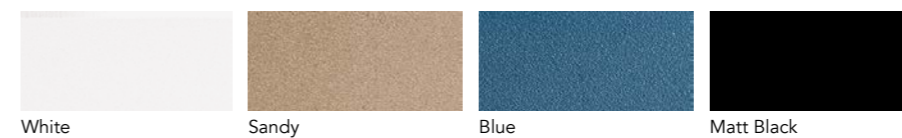

Kami up&down

design by C. Cattaneo

La lampada Kami up&down è un'elegante lampada a sospensione biemissione dotata di proxy dimmer, il che significa che puoi gestire separatamente la luce diretta e indiretta utilizzando dimmer indipendenti.

Questo ti offre il controllo completo dell'atmosfera luminosa nella tua casa, consentendoti di creare l'ambiente perfetto per ogni occasione. Il sistema di saliscendi con escursione di 1 metro ti permette di regolare l'altezza della lampada a tuo piacimento, adattandola alle diverse situazioni e necessità.

Con questa lampada, avrai non solo un'illuminazione funzionale, ma anche un elemento di design contemporaneo e versatile per arricchire il tuo spazio abitativo.

The Kami up&down lamp is an elegant bi-emission pendant lamp equipped with a proxy dimmer, which means you can manage direct and indirect light separately using independent dimmers.

This gives you complete control of the lighting atmosphere in your home, allowing you to create the perfect ambience for every occasion. The up and down system with 1 metre excursion allows you to adjust the height of the lamp to your liking, adapting it to different situations and needs.

With this lamp, you have not only functional lighting, but also a contemporary and versatile design element to enrich your living space.

Die Kami up&down Leuchte ist eine elegante, bi-emittierende Pendelleuchte, die mit einem Proxi-Dimmer ausgestattet ist.

Das bedeutet, dass Sie direktes und indirektes Licht separat mit unabhängigen Dimmern steuern können. So haben Sie die volle Kontrolle über die Lichtatmosphäre in Ihrem Zuhause und können für jeden Anlass das perfekte Ambiente schaffen. Das Auf- und Abwärtssystem mit 1 Meter Auszug ermöglicht es Ihnen, die Höhe der Leuchte nach Ihren Wünschen einzustellen und sie an verschiedene Situationen und Bedürfnisse anzupassen.

Mit dieser Leuchte haben Sie nicht nur eine funktionelle Beleuchtung, sondern auch ein modernes und vielseitiges Designelement, das Ihren Wohnraum bereichert.





Guarda il video
Watch the video
Video ansehen



Kami Up & Down | Suspension

992/120 S

LED 64W 24V Dc 220 - 240V
7160lm 3000°K upon request 2700°/4000°K
Net weight 4200gr - Gross weight 6850gr
volume m³ 0.090

with proxy dimmer

CE IP20

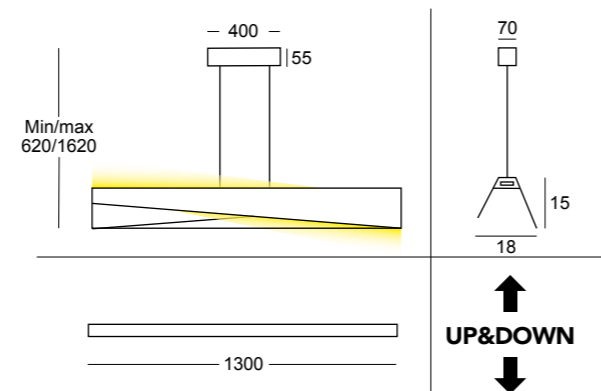

Special colours

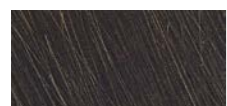

Bronze



Plated Gold

991/120 S

LED 64W 24V Dc 220 - 240V
7160lm 3000°K upon request 2700°/4000°K
Net weight 4200gr - Gross weight 6850gr
volume m³ 0.090

with proxy dimmer

CE IP20

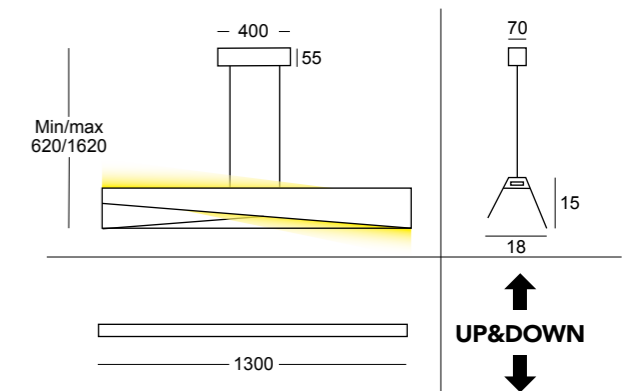

Standard colours

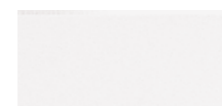

White



Sandy



Blue



Green



Champagne



Grey



Kami

design by C. Cattaneo

Un gesto che ricorda la cultura orientale degli origami e che ne diventa espressione contemporanea. Attraverso un'unica piegatura e un taglio diagonale sapientemente disegnato, Kami è in grado di celare la fonte luminosa per lasciare spazio ad una sfumatura di luce che diventa così la vera protagonista di questo prodotto scultoreo. La doppia cromia tra esterno ed interno enfatizza l'effetto luminoso e rende la lampada personalizzabile e adattabile a qualsiasi ambiente. La collezione, composta da lampade a sospensione disponibili in due dimensioni, è completata da una versione a parete.

A gesture reminding the Eastern culture of the origami, becoming its contemporary expression. Thanks to its unique bending and its wisely designed diagonal cut, Kami is able to conceal the light source leaving space to hues of light: real protagonists of this sculpted product. The double tone between inside and outside emphasises the luminous effect. In this way the light can be customized, becoming suitable for any environment. The collection, made up of pendant lights available in two sizes, is integrated by a wall variation.

Eine Geste, die an die orientalische Kultur des Origami erinnert und zu seinem zeitgenössischen Ausdruck wird. Durch eine einzige Falte und einen raffiniert gestalteten Schrägschnitt kann Kami die Lichtquelle verstecken, um Platz für eine Lichtnuance zu schaffen, die zum eigentlichen Protagonisten dieses skulpturalen Produkts wird. Die doppelte Farbgebung zwischen Außen und Innen unterstreicht die Lichtwirkung und macht die Leuchte anpassbar und anpassungsfähig an jede Umgebung. Die Kollektion, bestehend aus Pendelleuchten in zwei Größen, wird durch eine Wandversion ergänzt.







791/90 S

LED 2x15W 230V
 4000lm 3000°K upon request 2700°/4000°K
 Net weight 1590gr - Gross weight 3495gr
 Volume m³ 0,052

PHASE-CUT DIMMING

791/120 S

LED 3x15W 230V
 6000lm 3000°K upon request 2700°/4000°K
 Net weight 2350gr - Gross weight 5000gr
 Volume m³ 0,090

PHASE-CUT DIMMING

Special colours

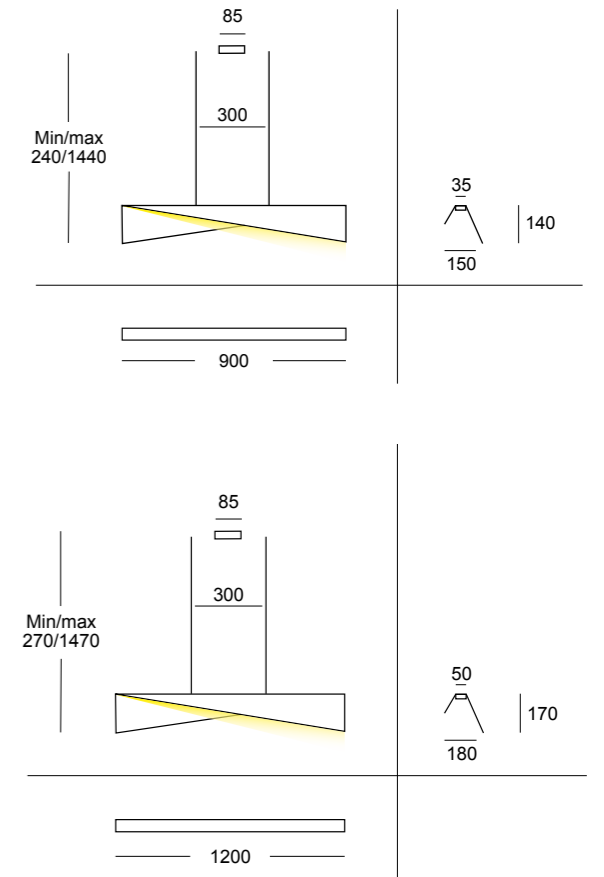
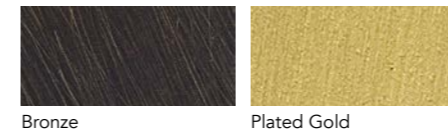

891/90 S

LED 2x15W 230V
 4000lm 3000°K upon request 2700°/4000°K
 Net weight 1590gr - Gross weight 3495gr
 Volume m³ 0,052

PHASE-CUT DIMMING

891/120 S

LED 3x15W 230V
 6000lm 3000°K upon request 2700°/4000°K
 Net weight 2350gr - Gross weight 5000gr
 Volume m³ 0,090

PHASE-CUT DIMMING

Standard colours

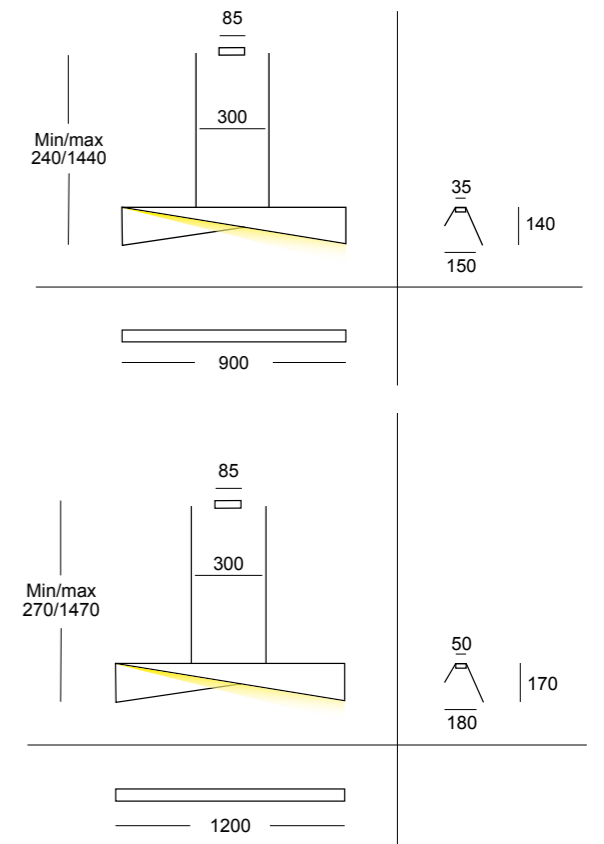
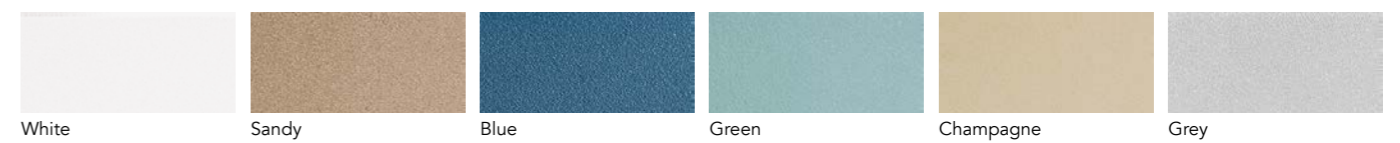





791/30 A

LED 1x15W 230V
 1500lm 3000°K upon request 2700°/4000°K
 Net weight 300gr - Gross weight 640gr
 Volume m³ 0,012

 PHASE-CUT DIMMING

CE  IP20

Special colours

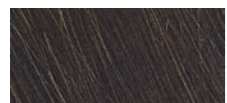

Bronze



Plated Gold

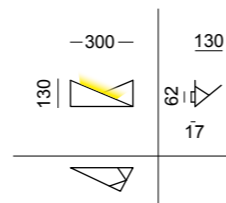

891/30 A

LED 1x15W 230V
 1500lm 3000°K upon request 2700°/4000°K
 Net weight 300gr - Gross weight 640gr
 Volume m³ 0,012

 PHASE-CUT DIMMING

CE  IP20

Standard colours

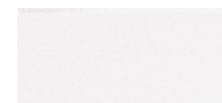

White



Sandy



Blue



Green

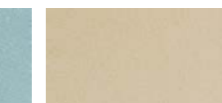

Champagne



Grey

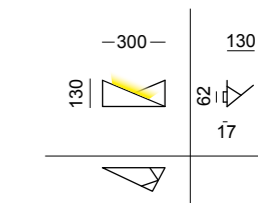

Katana

design by C. Cattaneo | EA Project

La lampada Katana a sospensione rappresenta un'armoniosa fusione tra l'eleganza e la moderna praticità. Caratterizzata da una forma unica che richiama una lama giapponese, questa lampada offre una soluzione di illuminazione versatile e distintiva.

Disponibile in due lunghezze, 100 cm e 130 cm, la Katana offre flessibilità nella scelta della dimensione, consentendo di adattarla alle esigenze specifiche dell'ambiente. La sua luce, sia verso l'alto che verso il basso, permette di creare un'atmosfera avvolgente e bilanciata.

La funzione dimmerabile offre un controllo totale sull'intensità della luce. La lampada è disponibile in due versioni: singola o doppia con unica alimentazione, consentendo di adattarla alle esigenze specifiche di illuminazione dell'utente.

Realizzata in alluminio di alta qualità, la lampada Katana è un'opzione di illuminazione affidabile e duratura. La sua forma particolare e distintiva è enfatizzata dalla disponibilità di colori classici come il bianco, il nero e il sabbia e dalle nuove versioni in ottone satinato, bronzo satinato e nero spazzolato. Queste opzioni cromatiche aggiungono un tocco di raffinatezza e permettono di integrare la lampada in qualsiasi contesto di arredamento.

In conclusione, la lampada Katana a sospensione non è solo un elemento di illuminazione funzionale ma anche un'opzione esteticamente affascinante e versatile che si adatta a diverse preferenze e stili di arredamento.

The Katana pendant lamp represents a harmonious fusion of elegance and modern practicality. Characterised by a unique shape reminiscent of a Japanese blade, this lamp offers a versatile and distinctive lighting solution.

Available in two lengths, 100 cm and 130 cm, Katana offers flexibility in the choice of size, allowing it to be adapted to the specific needs of the room. Its upward and downward light creates an enveloping and balanced atmosphere.

The dimmable function offers total control over the intensity of the light. The lamp is available in two versions: single or double with a single power supply, allowing it to fit the user's specific lighting needs.

Made of high-quality aluminium, the Katana lamp is a reliable and durable lighting option. Its distinctive shape is emphasised by the availability of classic colours such as white, black and sand as well as new versions in satin brass, satin bronze and brushed black. These colour options add a touch of sophistication and allow the lamp to be integrated into any furnishing context.

In conclusion, the Katana pendant lamp is not only a functional lighting element, but also an aesthetically appealing and versatile option that adapts to different preferences and furnishing styles.

Die Pendelleuchte Katana ist eine harmonische Verbindung von Eleganz und moderner Zweckmäßigkeit. Mit ihrer einzigartigen Form, die an eine japanische Klinge erinnert, bietet diese Leuchte eine vielseitige und unverwechselbare Beleuchtungslösung.

Erhältlich in zwei Längen, 100 cm und 130 cm, bietet die Katana Flexibilität bei der Wahl der Größe, so dass sie an die spezifischen Bedürfnisse des Raums angepasst werden kann. Ihr nach oben und unten gerichtetes Licht schafft eine einhüllende und ausgewogene Atmosphäre.

Die dimmbare Funktion ermöglicht die vollständige Kontrolle über die Lichtintensität. Die Leuchte ist in zwei Versionen erhältlich: einfach oder doppelt mit einer einzigen Stromversorgung, so dass sie an die spezifischen Beleuchtungsbedürfnisse des Benutzers angepasst werden kann.

Die aus hochwertigem Aluminium gefertigte Leuchte Katana ist eine zuverlässige und langlebige Beleuchtungsoption. Ihre markante Form wird durch die Verfügbarkeit klassischer Farben wie Weiß, Schwarz und Sand sowie neuer Versionen in satiniertem Messing, satiniertes Bronze und gebürstetem Schwarz unterstrichen. Diese Farboptionen verleihen der Leuchte einen Hauch von Raffinesse und ermöglichen es, sie in jeden Einrichtungskontext zu integrieren.

Zusammenfassend lässt sich sagen, dass die Katana-Pendelleuchte nicht nur ein funktionelles Beleuchtungselement ist, sondern auch eine ästhetisch ansprechende und vielseitige Option, die sich an unterschiedliche Vorlieben und Einrichtungsstile anpasst.





Special colours

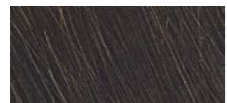

Bronze



Plated Gold

Single version

970/100 S

LED 3x7W+1x7W 24V Dc 220 - 240V

4000lm 3000°K upon request 2700°/4000°K

Net weight 1510gr - Gross weight 2710gr

Volume m³ 0,021

 with leading edge or trailing edge dimmer

  IP20

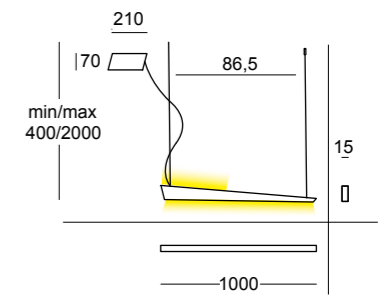

970/130 S

LED 4x7W + 2x7W 24V Dc 220 - 240V

6000lm 3000°K upon request 2700°/4000°K

Net weight 2300gr - Gross weight 4400gr

Volume m³ 0,05244

 with leading edge or trailing edge dimmer

  IP20

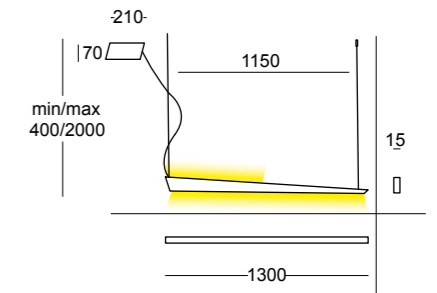

Double version

970/100 S2

LED 6x7W + 2x7W 24V Dc 220 - 240V

8000lm 3000°K upon request 2700°/4000°K

Net weight 3600gr - Gross weight 5400gr

Volume m³ 0,021

 with leading edge or trailing edge dimmer

  IP20

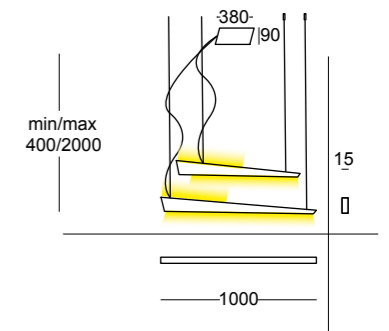

970/130 S2

LED 8x7W + 4x7W 24V Dc 220 - 240V

12000lm 3000°K upon request 2700°/4000°K

Net weight 4500gr - Gross weight 9200gr

Volume m³ 0,052

 with leading edge or trailing edge dimmer

  IP20

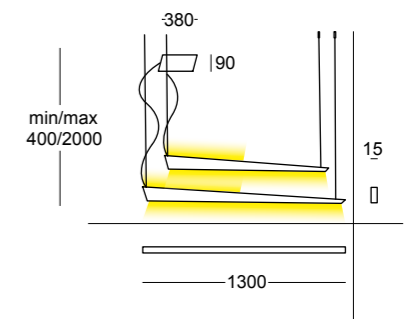





Standard colours



White

Sandy

Matt Black

Single version

870/100 S

LED 3x7W+1x7W 24V Dc 220 - 240V
 4000lm 3000°K upon request 2700°/4000°K
 Net weight 1510gr - Gross weight 2710gr
 Volume m³ 0,021

with leading edge or trailing edge dimmer

CE IP20

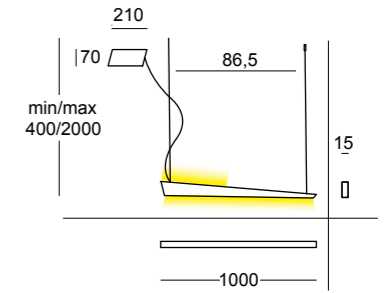

870/130 S

LED 4x7W + 2x7W 24V Dc 220 - 240V
 6000lm 3000°K upon request 2700°/4000°K
 Net weight 2300gr - Gross weight 4400gr
 Volume m³ 0,05244

with leading edge or trailing edge dimmer

CE IP20

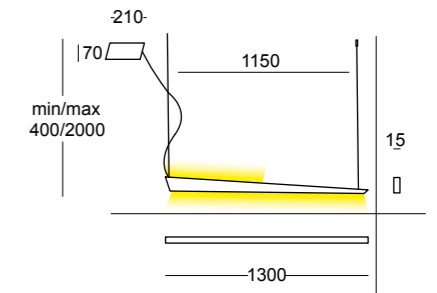

Double version

870/100 S2

LED 6x7W + 2x7W 24V Dc 220 - 240V
 8000lm 3000°K upon request 2700°/4000°K
 Net weight 3600gr - Gross weight 5400gr
 Volume m³ 0,021

with leading edge or trailing edge dimmer

CE IP20

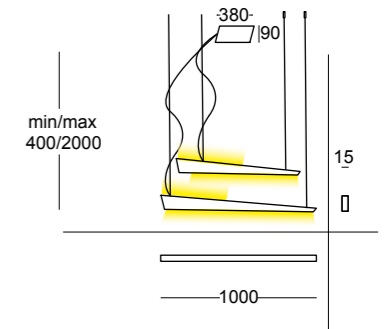

870/130 S2

LED 8x7W + 4x7W 24V Dc 220 - 240V
 12000lm 3000°K upon request 2700°/4000°K
 Net weight 4500gr - Gross weight 9200gr
 Volume m³ 0,052

with leading edge or trailing edge dimmer

CE IP20

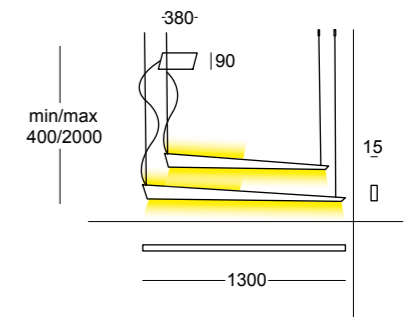



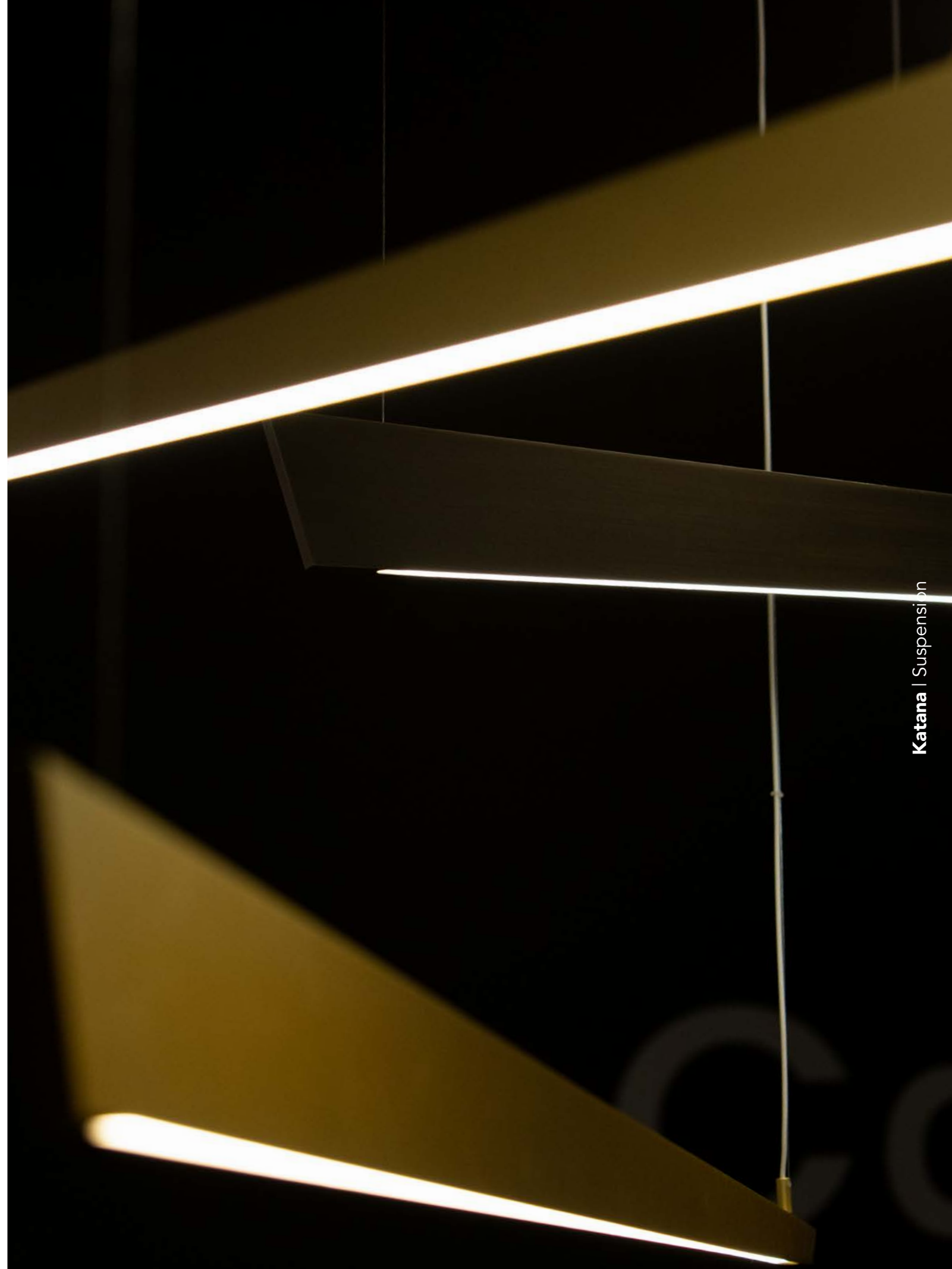
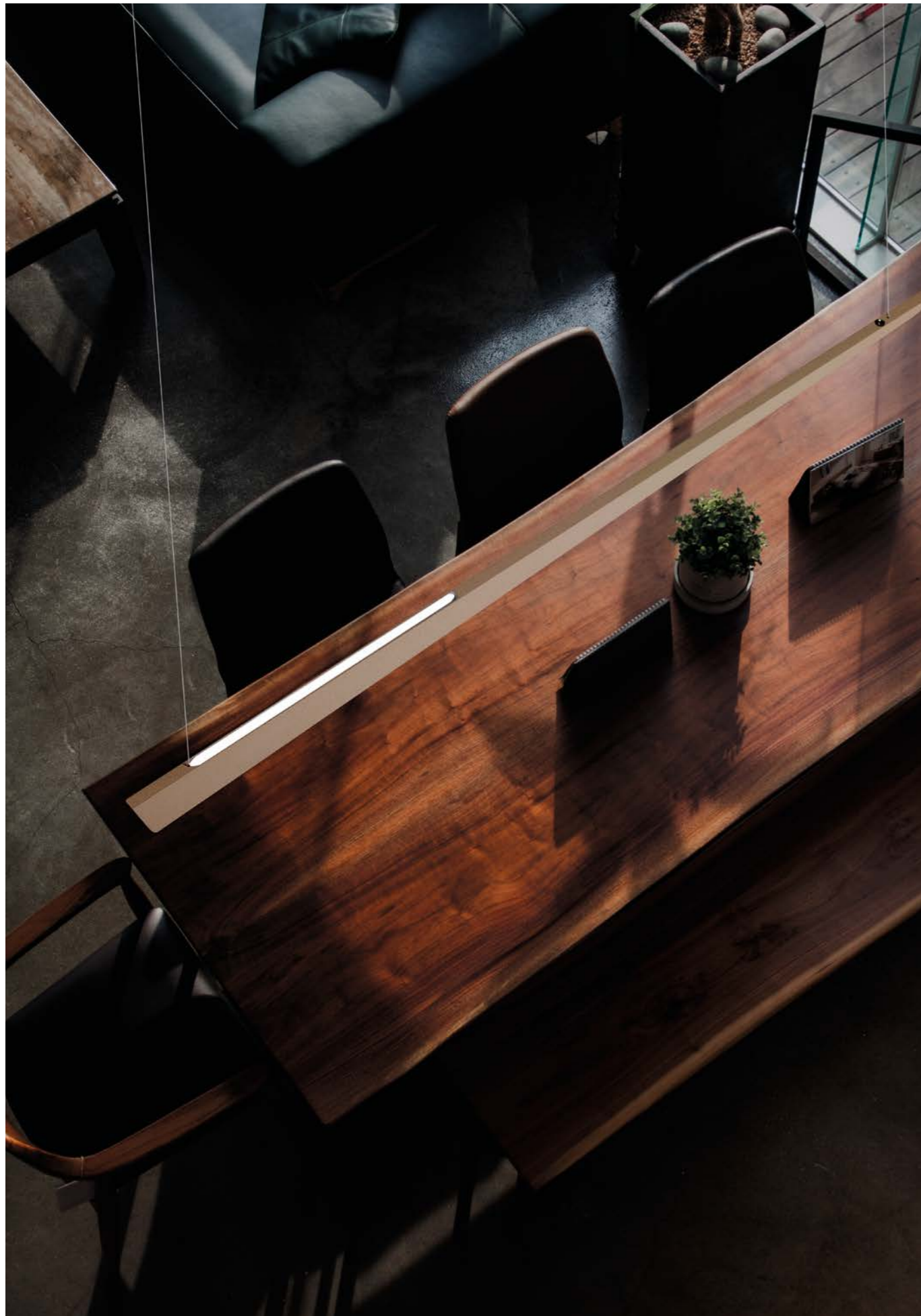

Heron

design by C. Cattaneo

La lampada Heron rappresenta un'eccellenza nell'illuminazione contemporanea. Con il suo design elegante e moderno, offre una versatilità senza pari. Disponibile in tre versioni - parete, plafone e sospensione - la Heron si adatta perfettamente a una vasta gamma di contesti e preferenze di illuminazione.

La versione a parete della lampada Heron consente un'installazione sia verticale che orizzontale, offrendo la flessibilità necessaria per adattarsi agli spazi e ai gusti personali. Inoltre, è possibile regolare l'orientamento della luce verso l'alto o verso destra e sinistra, permettendo di creare atmosfere personalizzate e di illuminare gli ambienti in modo delicato o focalizzato.

Per coloro che cercano soluzioni di illuminazione più dinamiche, la versione a sospensione della Heron offre ulteriori possibilità creative. Disponibile sia in configurazione singola che in composizione di più lampade, questa opzione consente di creare installazioni uniche e accattivanti. Durante l'installazione, è possibile scegliere tra luce diretta o indiretta, garantendo un'illuminazione su misura per ogni esigenza.

In sintesi, la lampada Heron fonde un design sofisticato con funzionalità avanzate, offrendo una soluzione di illuminazione versatile e di alta qualità per una vasta gamma di ambienti e applicazioni.

The Heron lamp represents excellence in contemporary lighting. With its sleek and modern design, it offers unparalleled versatility. Available in three versions - wall, ceiling and pendant - the Heron is perfectly suited to a wide range of lighting contexts and preferences.

The wall-mounted version of the Heron lamp allows for both vertical and horizontal installation, offering the flexibility to adapt to spaces and personal tastes. In addition, the orientation of the light can be adjusted upwards or left and right, allowing for customised atmospheres and subtle or focused room lighting.

For those looking for more dynamic lighting solutions, the pendant version of the Heron offers further creative possibilities. Available in both single and multi-lamp configurations, this option allows for unique and eye-catching installations. During installation, it is possible to choose between direct or indirect light, providing tailor-made lighting for all needs.

In brief, the Heron lamp fuses sophisticated design with advanced functionality, offering a versatile, high quality lighting solution for a wide range of environments and applications.

Die Heron-Lampe steht für die Exzellenz zeitgenössischer Beleuchtung. Mit ihrem eleganten und modernen Design bietet sie eine unvergleichliche Vielseitigkeit. Erhältlich in drei Versionen - Wand-, Decken- und Pendelleuchte - eignet sich die Heron perfekt für eine Vielzahl von Beleuchtungskontexten und -vorlieben.

Die Wandleuchte Heron kann sowohl vertikal als auch horizontal montiert werden und bietet so die Möglichkeit, sich dem persönlichen Raum und Geschmack anzupassen. Darüber hinaus kann die Ausrichtung der Leuchte nach oben oder nach links und rechts verstellt werden, was eine individuelle Atmosphäre und eine subtile oder konzentrierte Raumbeleuchtung ermöglicht.

Für diejenigen, die nach dynamischeren Beleuchtungslösungen suchen, bietet die Pendelversion der Heron weitere kreative Möglichkeiten. Sie ist sowohl als ein- als auch als mehrflammiige Variante erhältlich und ermöglicht einzigartige und auffällige Installationen. Bei der Installation kann zwischen direktem und indirektem Licht gewählt werden, so dass eine maßgeschneiderte Beleuchtung für jeden Bedarf möglich ist.

Zusammenfassend lässt sich sagen, dass die Heron-Leuchte anspruchsvolles Design mit fortschrittlicher Funktionalität verbindet und eine vielseitige, qualitativ hochwertige Beleuchtungslösung für eine Vielzahl von Umgebungen und Anwendungen bietet.





810/75 ADS

LED 2x6W 24V Dc 220 - 240V

1500lm 3000°K upon request 2700°/4000°K

Net weight 1500gr - Gross weight 2300gr

Volume m³ 0.080

 with leading edge or trailing edge dimmer

CE  IP20

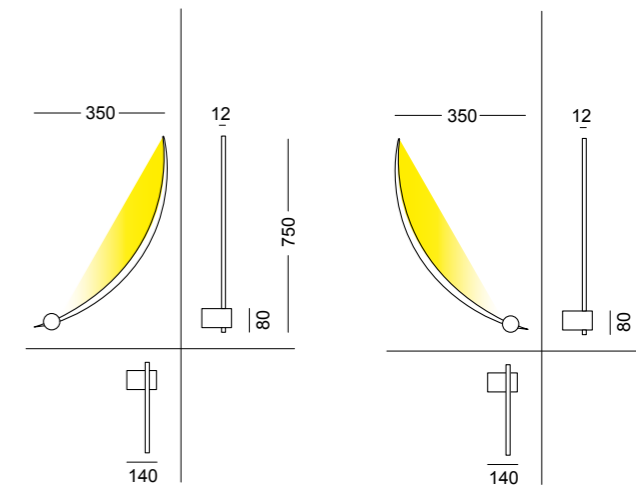

810/95 ADS

LED 3x6W 24V Dc 220 - 240V

2250lm 3000°K upon request 2700°/4000°K

Net weight 2500gr - Gross weight 4300 gr

Volume m³ 0.080

 with leading edge or trailing edge dimmer

CE  IP20

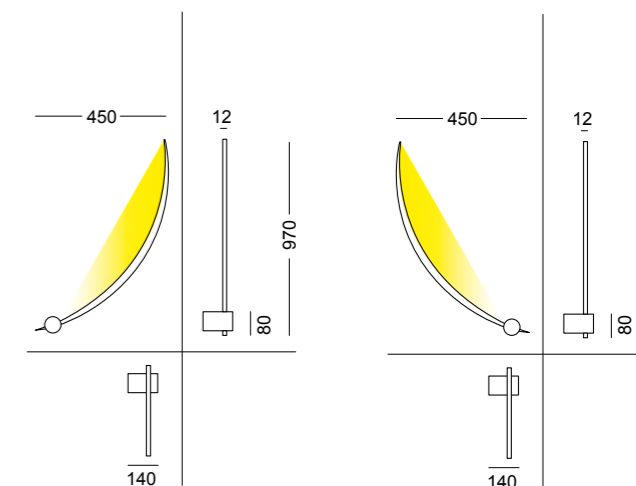

810/120 ADS

LED 4x6W 24V Dc 220 - 240V

3000lm 3000°K upon request 2700°/4000°K

Net weight 3300gr - Gross weight 6300gr

Volume m³ 0.15

 with leading edge or trailing edge dimmer

CE  IP20

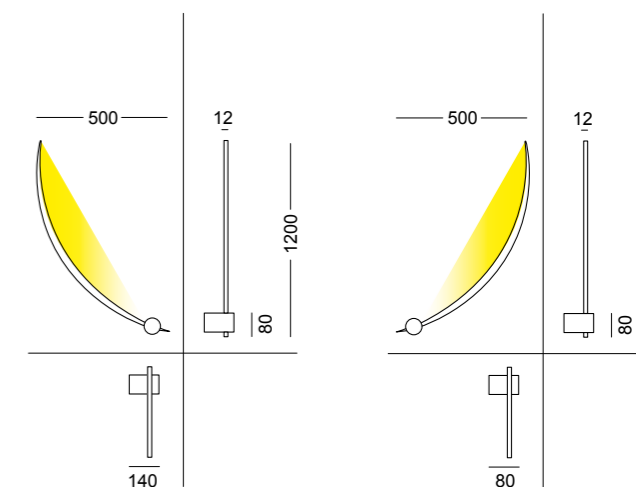

White

Sandy

Matt Black



White

Sandy

Matt Black







White

Sandy

Matt Black

810/75 PA

LED 2x6W 24V Dc 220 - 240V

1500lm 3000°K upon request 2700°/4000°K

Net weight 1500gr - Gross weight 2300gr

Volume m³ 0.080

 with leading edge or trailing edge dimmer

CE  IP20

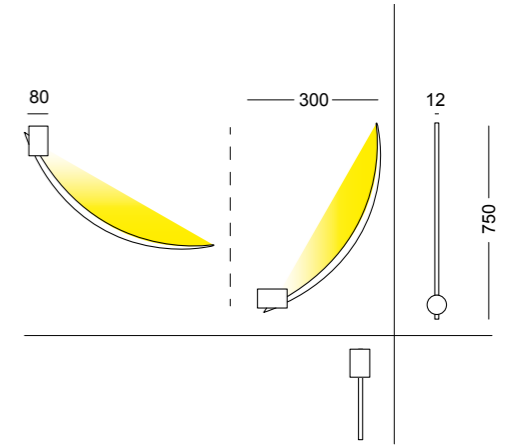

810/95 PA

LED 3x6W 24V Dc 220 - 240V

2250 lm 3000°K upon request 2700°/4000°K

Net weight 2500gr - Gross weight 4300gr

Volume m³ 0.080

 with leading edge or trailing edge dimmer

CE  IP20

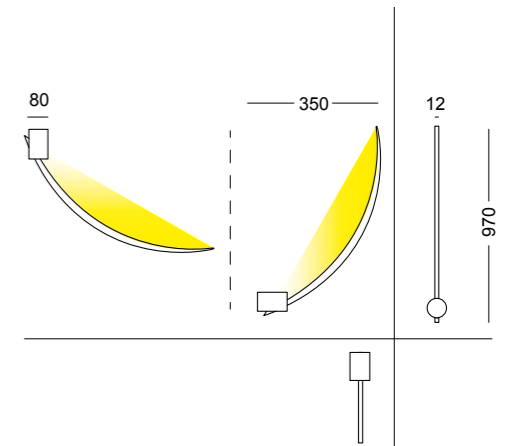

810/120 PA

LED 4x6W 24V Dc 220 - 240V

3000lm 3000°K upon request 2700°/4000°K

Net weight 3300gr - Gross weight 6300gr

Volume m³ 0.15

 with leading edge or trailing edge dimmer

CE  IP20

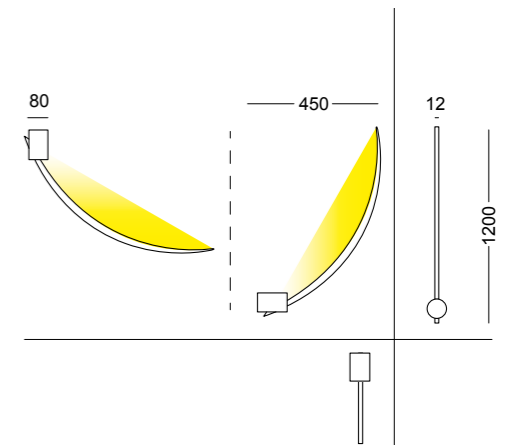





Single versions

810/95 S

LED 3x6W 24V Dc 220 - 240V
 2250lm 3000°K upon request 2700°/4000°K
 Net weight 2500gr - Gross weight 4300gr
 volume m³ 0.080

 with leading edge or trailing edge dimmer

 

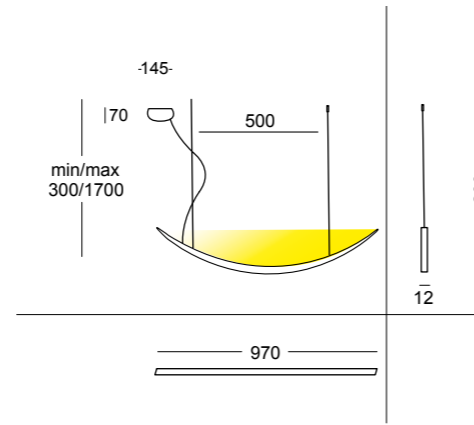

Multiple-lamp versions

810/95 M

LED 3x6W 24V Dc 220 - 240V
 2250lm 3000°K upon request 2700°/4000°K
 Net weight 2500gr - Gross weight 4300gr
 volume m³ 0.080

 with leading edge or trailing edge dimmer

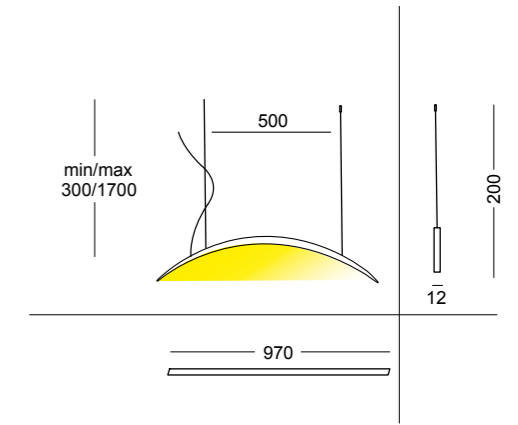

810/120 S

LED 4x6W 24V Dc 220 - 240V
 3000lm 3000°K upon request 2700°/4000°K
 Net weight 3300gr - Gross weight 6600gr
 volume m³ 0.15

 with leading edge or trailing edge dimmer

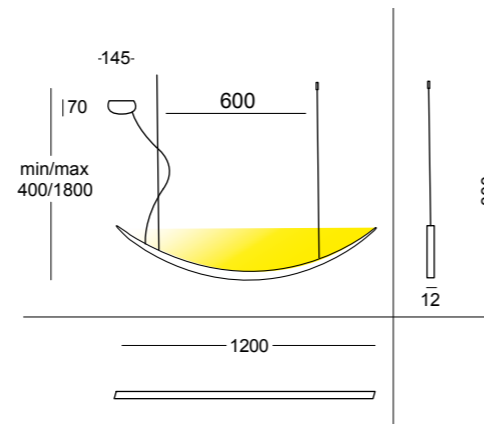

810/120 M

LED 4x6W 24V Dc 220 - 240V
 3000lm 3000°K upon request 2700°/4000°K
 Net weight 3300gr - Gross weight 6600gr
 volume m³ 0.15

 with leading edge or trailing edge dimmer

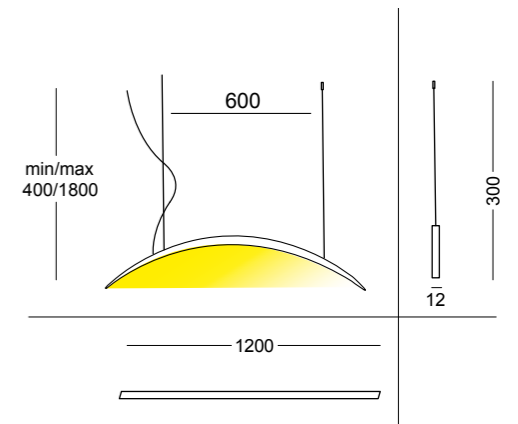

White

Sandy

Matt Black

Base

810/15 R2

Net weight 500gr
 Gross weight 1500gr
 Volume m³ 0.009



810/15 R3

Net weight 600gr
 Gross weight 1600gr
 Volume m³ 0.009

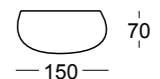

Well

design by C. Cattaneo

La luce è movimento: dall'alba al crepuscolo l'universo si trasforma in configurazioni luminose sempre diverse a seconda degli orari del giorno. Well è in grado di modificare la luce emessa grazie ad un semplice gesto che trasforma il suo fascio da diretto a indiretto, modificando la percezione dello spazio circostante e adattando il tipo di luce a specifici bisogni. Un cilindro principale con funzione diffondente e un cilindro inferiore che contiene la sorgente led, sono le componenti essenziali di questa lampada che appare come un lucernario all'interno degli ambienti, adattandosi con naturalezza alle più svariate esigenze di utilizzo.

Light is movement: from sunrise to sunset the universe turns into always different luminous configurations depending on the time of the day. Well is able to adjust the light released thanks to a simple gesture that converts its beam of light from direct to indirect, modifying the sense of the surrounding space and adjusting the light to specific needs. A main cylinder with a diffusing function and a lower cylinder holding the LED source are the essential components of this light that appears as a skylight in an environment, masterly complying with the most varied needs.

Licht ist Bewegung: Von morgens bis abends verwandelt sich das Universum in leuchtende Konfigurationen, die je nach Tageszeit immer unterschiedlich sind. Well ist in der Lage, das ausgestrahlte Licht durch eine einfache Geste zu verändern, die seinen Strahl von direkt auf indirekt umwandelt, die Wahrnehmung des umgebenden Raumes verändert und die Art des Lichts an die spezifischen Bedürfnisse anpasst. Ein Hauptzylinder mit Diffusionsfunktion und ein unterer Zylinder mit der LED-Quelle sind die folgenden wesentliche Bestandteile dieser Lampe, die wie ein Oberlicht in den Räumen aussieht und sich natürlich an die unterschiedlichsten Nutzungsbedürfnisse anpasst.





Well | Ceiling



White

Sandy

Blue

Green

Champagne



Well | Ceiling

893/40 PA

LED 1x25W 230V

2500lm 3000°K upon request 2700°/4000°K

CE IP20

Net weight 2900gr - Gross weight 4850gr

Volume m³ 0,061

 PHASE-CUT DIMMING

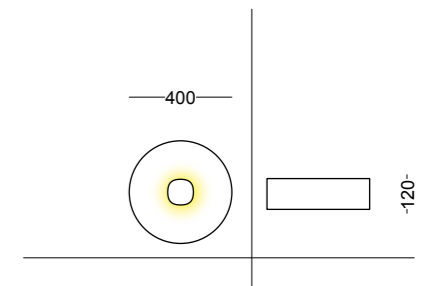

Olimpia

Olimpia touch

design by C. Cattaneo

Esplora un nuovo livello di versatilità e stile con la lampada da parete e plafone Olimpia, una fusione perfetta tra design contemporaneo e funzionalità avanzata.

La sua caratteristica principale è la regolabilità in tutte le direzioni, offrendo un controllo totale sulla direzione e sull'intensità della luce.

Disponibile in una raffinata gamma di colori, il bianco classico dona eleganza senza tempo, la tonalità sabbia aggiunge calore e serenità, il nero conferisce un tocco di modernità audace, mentre il grigio si presenta come una scelta sofisticata e neutra.

Alla gamma di colori tradizionali, si aggiungono le nuove versioni in oro satinato e bronzo satinato e nero spazzolato, per garantire ancora maggiori possibilità di scelta ai nostri clienti.

Questa lampada non è solo un complemento d'arredo, ma una dichiarazione di stile. La sua capacità di adattarsi a qualsiasi ambiente, combinata con la possibilità di personalizzare l'illuminazione secondo le tue esigenze, la rende un elemento essenziale per creare atmosfere uniche in ogni stanza.

Sperimenta il connubio di estetica e funzionalità con la lampada da parete Olimpia: un'illuminazione impeccabile che si adatta al tuo gusto personale e al design della tua casa.

Explore a new level of versatility and style with the Olimpia wall and ceiling lamp, a perfect fusion of contemporary design and advanced functionality. Its main feature is its adjustability in all directions, offering total control over the direction and intensity of the light.

Available in a refined range of colours, classic white lends timeless elegance, the sandy shade adds warmth and serenity, black lends a bold modern touch, while grey is a sophisticated, neutral choice.

To the range of traditional colours, new versions in satin gold and satin bronze and brushed black are added to provide even more choice for our customers.

This lamp is not just a furnishing accessory, but a style statement. Its ability to adapt to any environment, combined with the possibility of customising the lighting to suit your needs, makes it an essential element in creating unique atmospheres in any room.

Experience the combination of aesthetics and functionality with the Olimpia wall lamp: flawless lighting that adapts to your personal taste and the design of your home.

Entdecken Sie eine neue Ebene der Vielseitigkeit und des Stils mit der Wand- und Deckenleuchte Olimpia, einer perfekten Verschmelzung von modernem Design und fortschrittlicher Funktionalität. Ihr Hauptmerkmal ist die Verstellbarkeit in alle Richtungen, die eine vollständige Kontrolle über die Richtung und Intensität des Lichts ermöglicht.

Sie ist in einer raffinierten Farbpalette erhältlich: klassisches Weiß verleiht ihr zeitlose Eleganz, der sandfarbene Schirm sorgt für Wärme und Gelassenheit, Schwarz verleiht ihr einen kühnen, modernen Touch, während Grau eine raffinierte, neutrale Wahl darstellt.

Die Palette der traditionellen Farben wird durch neue Versionen in satiniertem Gold, satiniertes Bronze und gebürstetem Schwarz ergänzt, um unseren Kunden noch mehr Auswahl zu bieten.

Diese Leuchte ist nicht nur ein Einrichtungsaccessoire, sondern ein Stilmerkmal. Ihre Fähigkeit, sich an jede Umgebung anzupassen, und die Möglichkeit, die Beleuchtung an Ihre Bedürfnisse anzupassen, machen sie zu einem unverzichtbaren Element, um in jedem Raum eine einzigartige Atmosphäre zu schaffen.

Erleben Sie die Kombination von Ästhetik und Funktionalität mit der Wandleuchte Olimpia: eine makellose Beleuchtung, die sich Ihrem persönlichen Geschmack und dem Design Ihrer Wohnung anpasst.





Olimpia - Olimpia touch | Wall - Ceiling



962/16 DT

LED 1x15W 230V
 1800lm 3000°K upon request 2700°/4000°K
 Net weight 700gr - Gross weight 840gr
 Volume m³ 0,0024

 TOUCH DIMMING

CE  IP20

Special colours

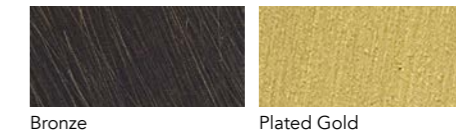

Bronze

Plated Gold

862/16 DT

LED 1x15W 230V
 1800lm 3000°K upon request 2700°/4000°K
 Net weight 700gr - Gross weight 840gr
 Volume m³ 0,0024

 TOUCH DIMMING

CE  IP20

Standard colours



White

Sandy

Matt Black

Grey

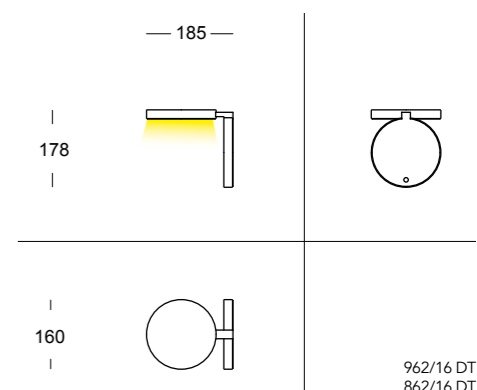

962/16 DT
 862/16 DT

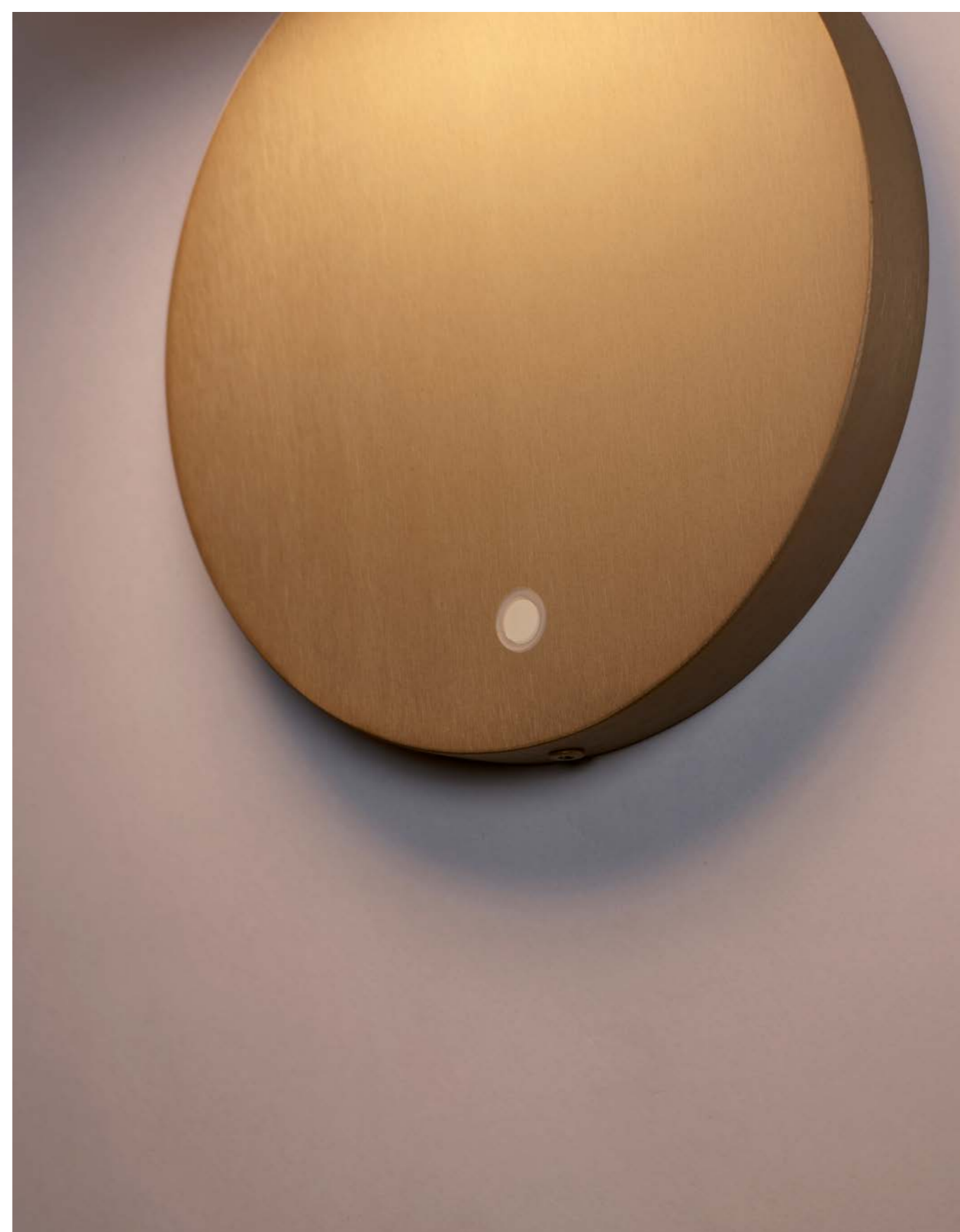

Olimpia - Olimpia touch | Wall - Ceiling

Guarda il video
Watch the video
Video ansehen





962/16 PA

LED 1x15W 230V
 1800lm 3000°K upon request 2700°/4000°K
 Net weight 700gr - Gross weight 840gr
 Volume m³ 0,0024

 TOUCH DIMMING

  IP20

Special colours

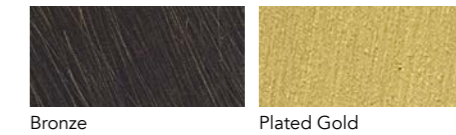

Bronze

Plated Gold

862/16 PA

LED 1x15W 230V
 1800lm 3000°K upon request 2700°/4000°K
 Net weight 700gr - Gross weight 840gr
 Volume m³ 0,0024

 TOUCH DIMMING

  IP20

Standard colours



White

Sandy

Matt Black

Grey

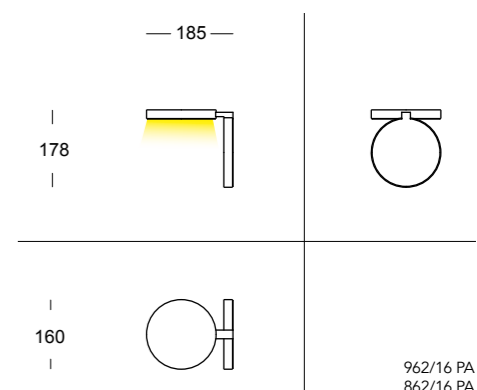

962/16 PA
 862/16 PA



Olimpia - Olimpia touch | Wall - Ceiling



Olimpia - Olimpia touch | Wall - Ceiling



Olimpia - Olimpia touch | Wall - Ceiling

Square

design by C. Cattaneo

Illumina con stile e funzionalità con la lampada da parete Square. Caratterizzata da un design moderno e pulito, la Square offre un'illuminazione versatile e sofisticata per ogni ambiente. Con il suo corpo basculante in alluminio e la luce indiretta regolabile, questa lampada si adatta perfettamente a una vasta gamma di contesti, aggiungendo un tocco di eleganza e modernità a qualsiasi spazio.

Illuminate with style and functionality with Square wall lamp. Characterised by a modern and clean design, Square offers versatile and sophisticated lighting for any environment. With its pivoting aluminium body and adjustable indirect light, this lamp fits perfectly in a wide range of contexts, adding a touch of elegance and modernity to any space.

Beleuchten Sie mit Stil und Funktionalität mit der Square Wandleuchte. Die Square zeichnet sich durch ein modernes und klares Design aus und bietet eine vielseitige und anspruchsvolle Beleuchtung für jede Umgebung. Mit ihrem schwenkbaren Aluminiumkörper und dem verstellbaren indirekten Licht passt diese Leuchte perfekt in eine Vielzahl von Kontexten und verleiht jedem Raum einen Hauch von Eleganz und Modernität.

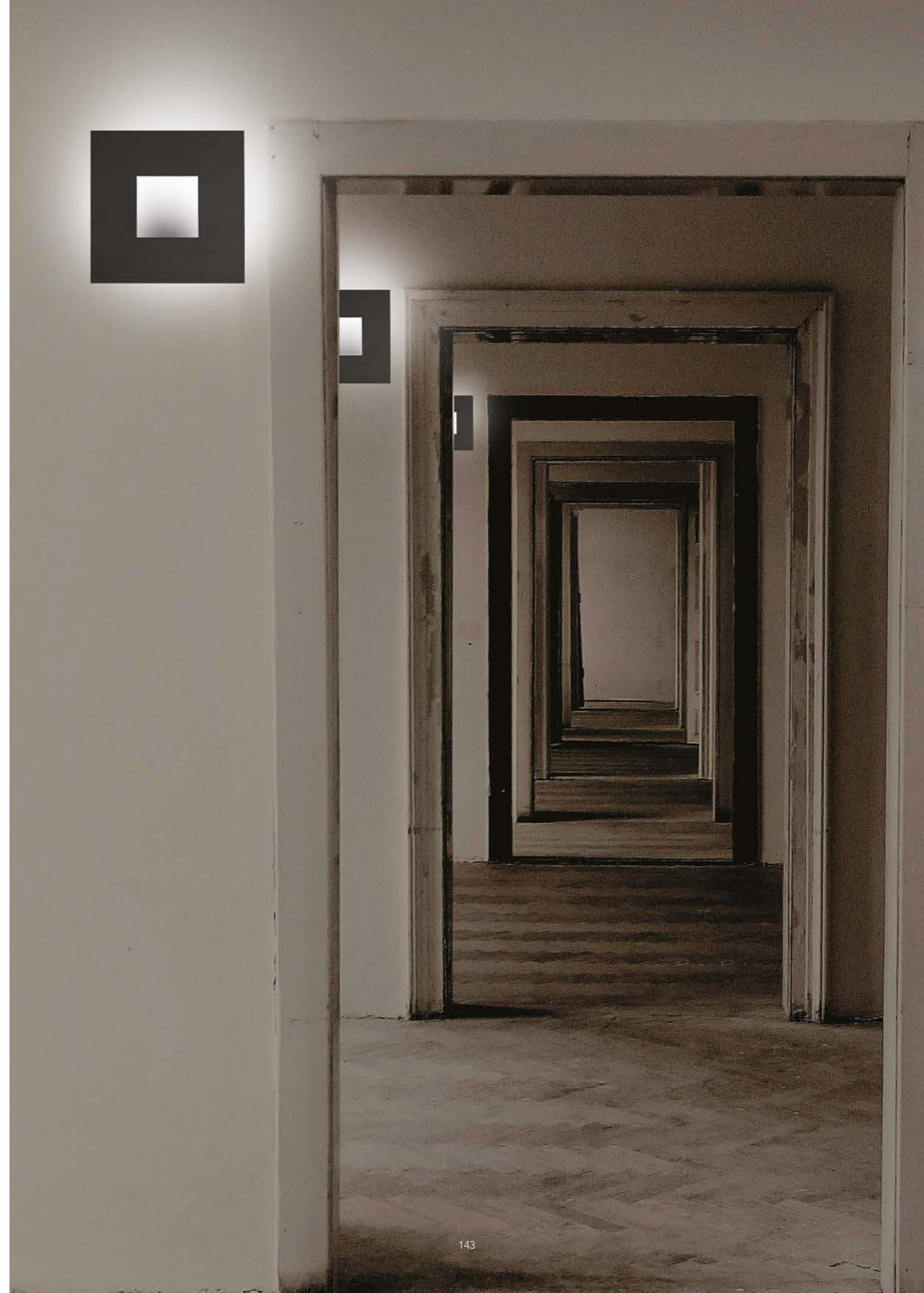

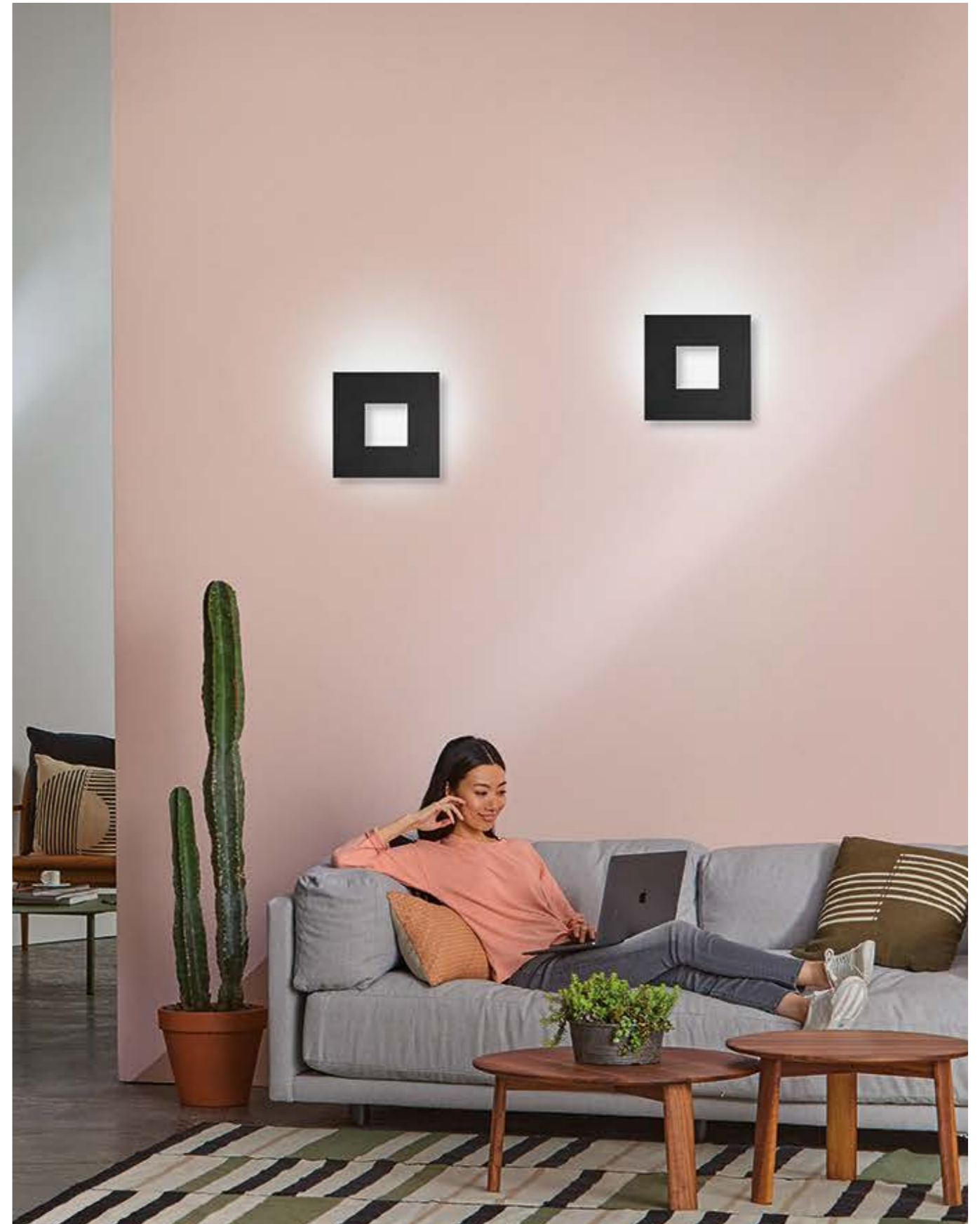





White

Sandy

Grey

Matt Black



860/20 A
 LED 3x8W 230V
 2400lm 3000°K upon request 2700°/4000°K
 CE IP20
 Net weight 720gr - Gross weight 990gr
 Volume m³ 0,012
 Dimmable PHASE-CUT DIMMING

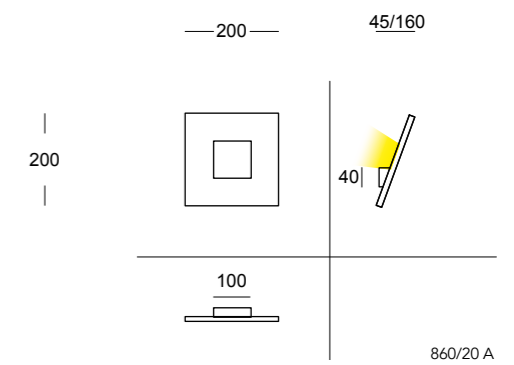

Rays

design by C. Cattaneo

Benvenuti nella collezione "Rays", un'incarnazione di eleganza minimalista e raffinata funzionalità. Le lampade della serie "Rays" trasportano l'osservatore in un mondo di morbidezza e armonia visiva, grazie alla loro forma delicatamente raggiata e curvata, che offre una luce avvolgente e non invasiva.

Disponibile in tre diverse varianti - sospensione, plafone e parete - "Rays" offre soluzioni luminose versatili per ogni esigenza di design. Caratterizzate da uno o due cerchi sottili e sinuosi, queste lampade creano un'atmosfera accogliente e moderna in qualsiasi ambiente.

La versione sospensione di "Rays" sospesa delicatamente dal soffitto, illumina lo spazio sottostante con una luce calda e avvolgente, creando un'atmosfera accogliente e rilassante. La versione plafone, invece, aggiunge un tocco di eleganza discreta al soffitto, diffondendo una luce morbida e uniforme nell'ambiente circostante. Infine, la versione parete di "Rays" offre una soluzione luminosa elegante e funzionale, perfetta per illuminare e valorizzare qualsiasi parete con stile e sofisticazione.

Realizzate con materiali di alta qualità e una meticolosa attenzione ai dettagli, le lampade della serie "Rays" incarnano l'essenza del design contemporaneo, combinando forma e funzione in modo armonioso e affascinante. Sia che si tratti di illuminare un salotto, una camera da letto o uno spazio commerciale, "Rays" si rivela una scelta impeccabile per chi cerca l'eleganza senza tempo e la praticità senza compromessi.

Welcome to the 'Rays' collection, an embodiment of minimalist elegance and refined functionality. The lamps in the 'Rays' series transport the observer into a world of softness and visual harmony, thanks to their gently radiating, curved shape that offers an enveloping, unobtrusive light.

Available in three different variants - pendant, ceiling and wall - 'Rays' offers versatile lighting solutions for every design requirement. Characterised by one or two slender, sinuous circles, these lamps create a cosy, modern atmosphere in any environment.

The pendant version of 'Rays' suspended gently from the ceiling, illuminates the space below with a warm, enveloping light, creating a cosy and relaxing atmosphere. The ceiling version, on the other hand, adds a touch of discreet elegance to the ceiling, diffusing a soft, even light into the surrounding space. Finally, the wall version of 'Rays' offers an elegant and functional lighting solution, perfect for illuminating and enhancing any wall with style and sophistication.

Made with high-quality materials and meticulous attention to detail, the lamps in the 'Rays' series embody the essence of contemporary design, combining form and function in a harmonious and fascinating way. Whether illuminating a living room, bedroom or retail space, 'Rays' proves to be a flawless choice for those seeking timeless elegance and uncompromising practicality.

Willkommen bei der Kollektion "Rays", einer Verkörperung minimalistischer Eleganz und raffinierter Funktionalität. Die Leuchten der Serie "Rays" entführen den Betrachter in eine Welt der Sanftheit und visuellen Harmonie, dank ihrer sanft strahlenden, geschwungenen Form, die ein umhüllendes, unaufdringliches Licht bietet.

Erhältlich in drei verschiedenen Varianten - Pendel-, Decken- und Wandleuchte - bietet Rays" vielseitige Beleuchtungslösungen für jeden Gestaltungswunsch. Gekennzeichnet durch einen oder zwei schlanke, gewundene Kreise, schaffen diese Lampen eine gemütliche, moderne Atmosphäre in jedem Ambiente.

Die Pendelleuchte 'Rays', die sanft von der Decke abgehängt wird, erhellt den Raum darunter mit einem warmen, einhüllenden Licht und schafft eine gemütliche und entspannende Atmosphäre. Die Deckenversion hingegen verleiht der Decke einen Hauch von diskreter Eleganz und verbreitet ein weiches, gleichmäßiges Licht in den umgebenden Raum. Die Wandversion von "Rays" schließlich bietet eine elegante und funktionelle Beleuchtungslösung, die jede Wand mit Stil und Raffinesse beleuchtet und aufwertet.

Die aus hochwertigen Materialien und mit viel Liebe zum Detail gefertigten Leuchten der Serie Rays" verkörpern die Essenz des zeitgenössischen Designs und verbinden Form und Funktion auf harmonische und faszinierende Weise. Ob zur Beleuchtung eines Wohn- oder Schlafzimmers oder eines Geschäftsraums, Rays" erweist sich als tadellose Wahl für alle, die zeitlose Eleganz und kompromisslose Zweckmäßigkeit suchen.



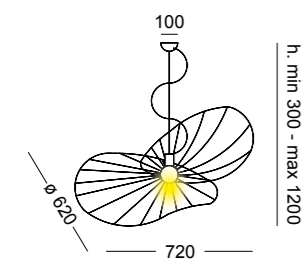

912/60 S
 220-240V-E27LED
 Net weight 2400gr
 Gross weight 4000gr
 Volume m³ 0.089
 CE IP20

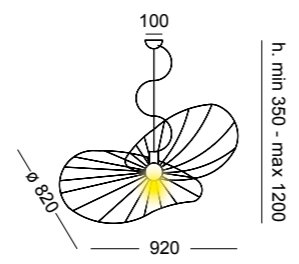

912/80 S
 220-240V-E27LED
 Net weight 3300gr
 Gross weight 5900gr
 Volume m³ 0.17
 CE IP20

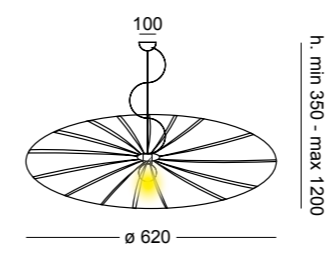
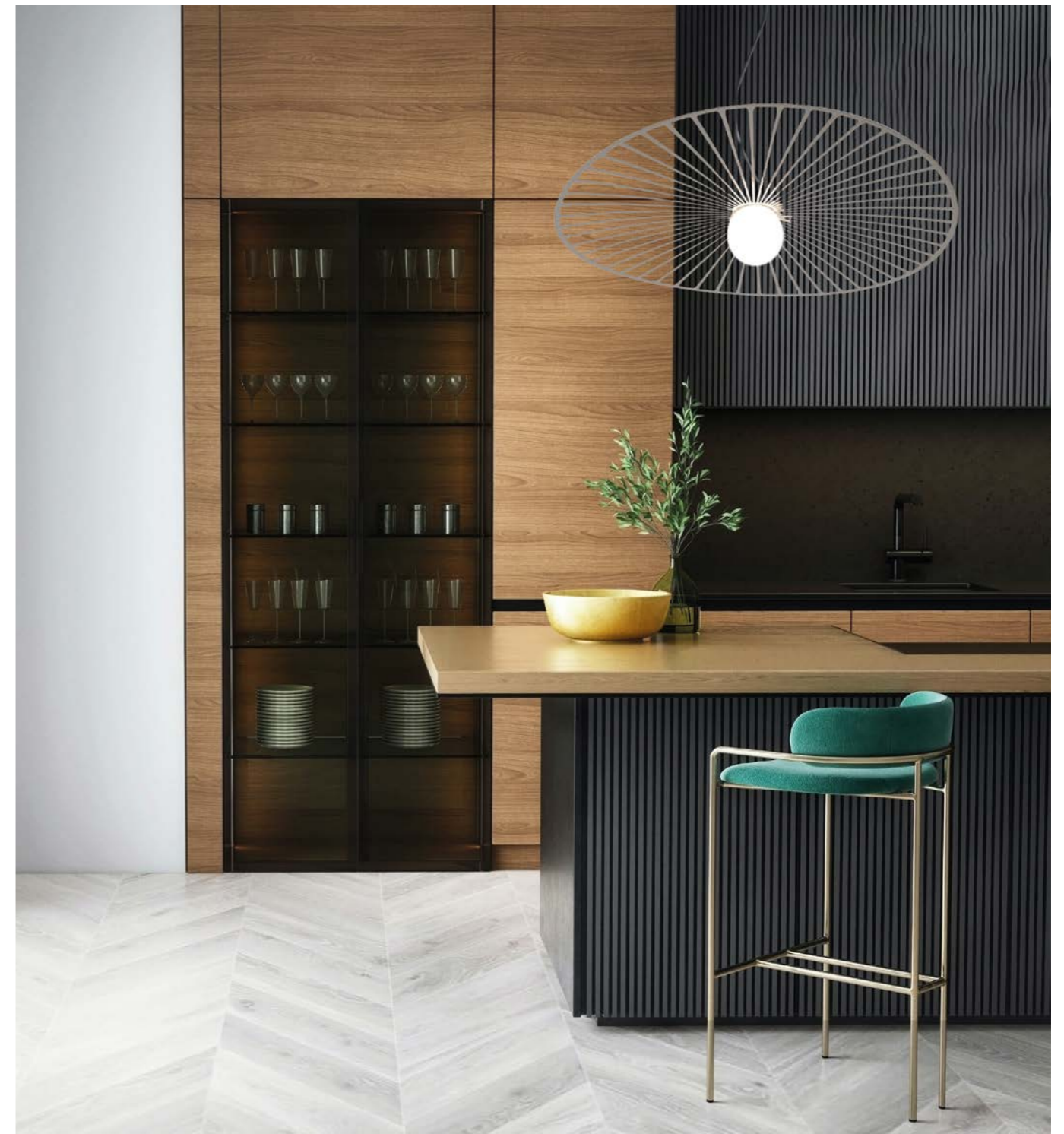

913/60 S
 220-240V-E27LED
 Net weight 1800gr
 Gross weight 3200gr
 Volume m³ 0.089
 CE IP20

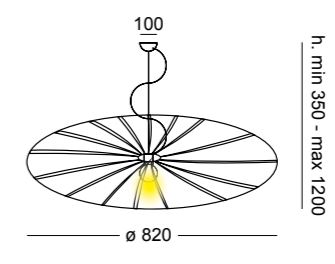

913/80 S
 220-240V-E27LED
 Net weight 2300gr
 Gross weight 4700gr
 Volume m³ 0.17
 CE IP20



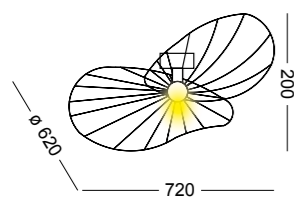

912/60 PA
 220-240V-E27LED
 Net weight 2400gr
 Gross weight 4000gr
 Volume m³ 0.089
 CE IP20

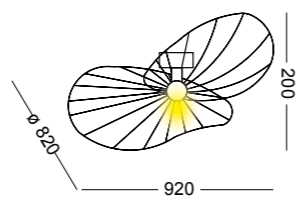

912/80 PA
 220-240V-E27LED
 Net weight 3300gr
 Gross weight 5900gr
 Volume m³ 0.17
 CE IP20

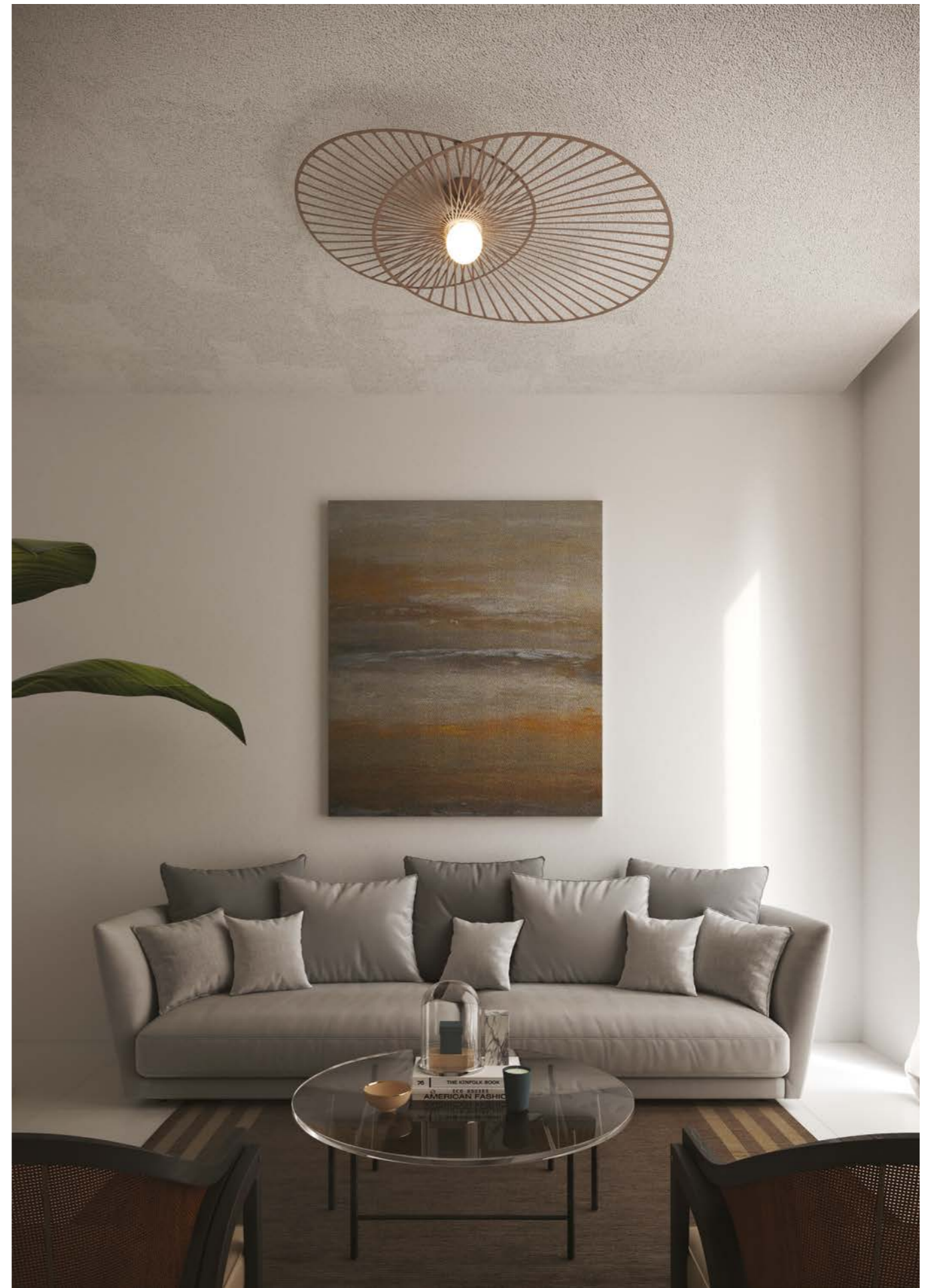

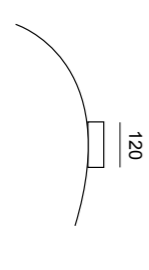
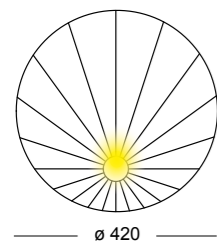

914/40 PA
 220-240V - GX53 LED
 Net weight 800gr
 Gross weight 1500gr
 Volume m³ 0.020
 CE IP20

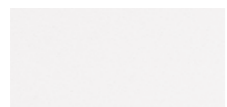

White

Black

Sandy

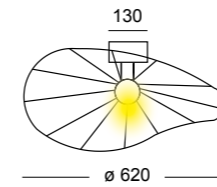
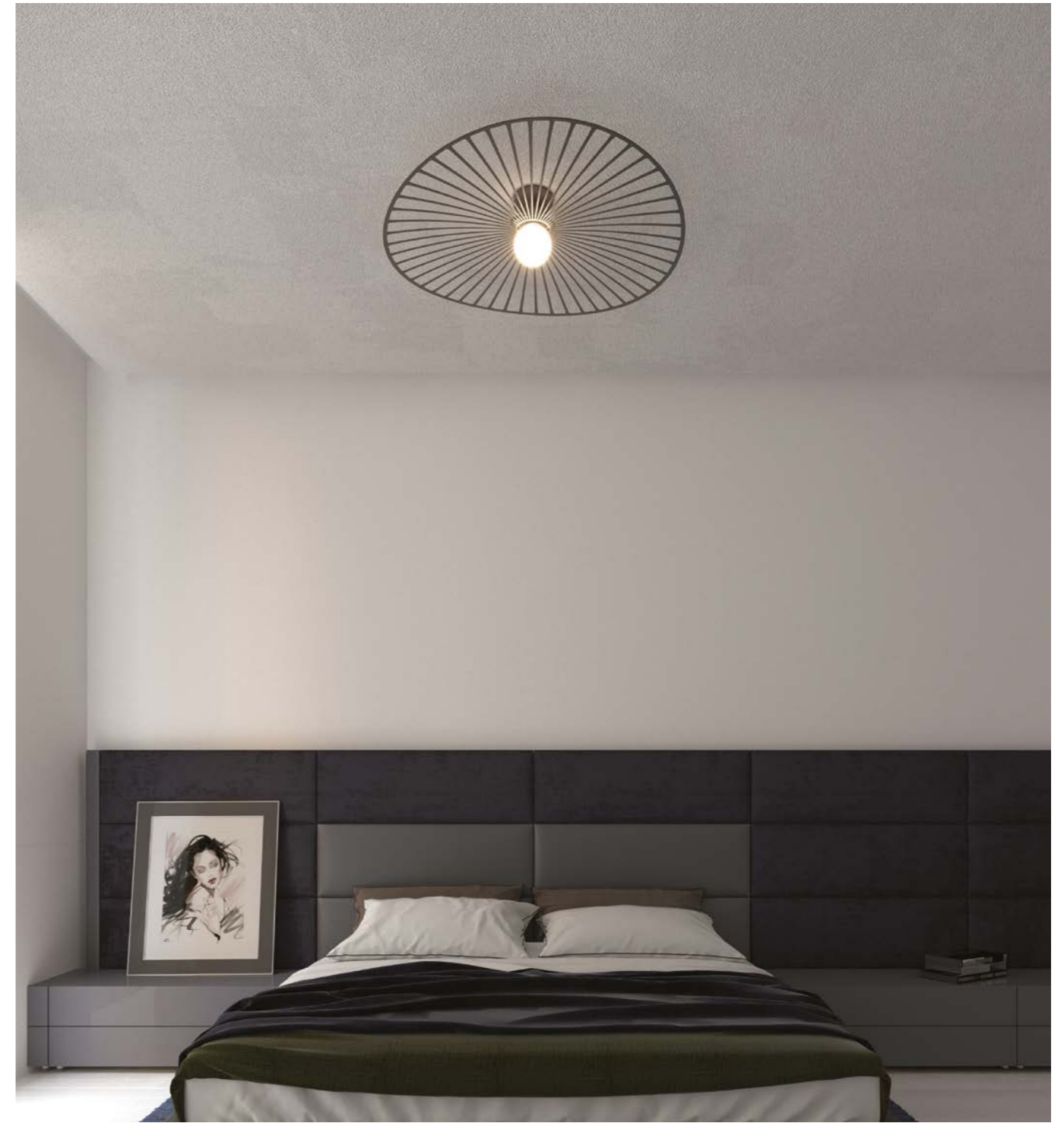

913/60 PA
 220-240V-E27LED
 Net weight 1800gr
 Gross weight 3200gr
 Volume m³ 0.089
 CE IP20

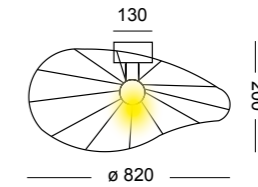

913/80 PA
 220-240V-E27LED
 Net weight 2300gr
 Gross weight 4700gr
 Volume m³ 0.17
 CE IP20

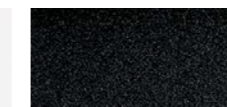
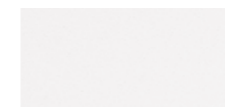

White

Black

Sandy

Nassa

design by A. Barra

La lampada Nassa sospensione rappresenta un'eccellente sintesi tra arte geometrica e illuminazione moderna. Realizzata in metallo tagliato al laser, assume la forma di una rete intricata che avvolge la sfera, creando una cupola unica e suggestiva.

Disponibile in due dimensioni, con diametri di 60 cm e 80 cm, la Nassa offre opzioni per adattarsi a diverse dimensioni di spazi. La geometria intricata della cupola consente una distribuzione uniforme della luce LED, creando un effetto di illuminazione suggestivo.

La scelta di colori tra bianco, nero e sabbia offre flessibilità nel coordinare la lampada con l'estetica dell'ambiente circostante. Il bianco conferisce un'eleganza luminosa, il nero aggiunge un tocco di modernità, mentre la sabbia crea un'atmosfera calda e accogliente.

La Nassa sospensione è un'opzione di illuminazione contemporanea che va oltre la funzionalità, trasformando lo spazio con il suo design artistico. La combinazione di metallo tagliato al laser e illuminazione LED la rende non solo una fonte di luce, ma anche un elemento decorativo d'effetto che cattura lo sguardo e aggiunge un tocco distintivo a qualsiasi ambiente.

The Nassa suspension lamp represents an excellent synthesis of geometric art and modern lighting. Made of laser-cut metal, it takes the form of an intricate net that wraps around the sphere, creating a unique and striking dome.

Available in two sizes, with diameters of 60 cm and 80 cm, the Nassa offers options to suit different sizes of spaces. The dome's intricate geometry allows for an even distribution of LED light, creating a striking lighting effect.

The choice of colours between white, black and sand offers flexibility in coordinating the lamp with the aesthetics of its surroundings. White lends a luminous elegance, black adds a modern touch, while sand creates a warm and welcoming atmosphere.

The Nassa pendant is a contemporary lighting option that goes beyond functionality, transforming the space with its artistic design. The combination of laser-cut metal and LED lighting makes it not only a source of light, but also a striking decorative element that catches the eye and adds a distinctive touch to any room.

Die Nassa Pendelleuchte stellt eine hervorragende Synthese aus geometrischer Kunst und moderner Beleuchtung dar. Sie besteht aus lasergeschnittenem Metall und hat die Form eines verschlungenen Netzes, das sich um die Kugel wickelt und so eine einzigartige und eindrucksvolle Kuppel bildet.

Nassa ist in zwei Größen mit Durchmessern von 60 cm und 80 cm erhältlich und bietet so die Möglichkeit, sich an unterschiedliche Raumgrößen anzupassen. Die ausgeklügelte Geometrie der Kuppel ermöglicht eine gleichmäßige Verteilung des LED-Lichts, wodurch ein eindrucksvoller Lichteffekt entsteht.

Die Farbauswahl zwischen Weiß, Schwarz und Sand bietet Flexibilität bei der Abstimmung der Leuchte auf die Ästhetik der Umgebung. Weiß verleiht ihr eine leuchtende Eleganz, Schwarz verleiht ihr einen modernen Touch, während Sand eine warme und einladende Atmosphäre schafft.

Die Nassa Pendelleuchte ist eine zeitgenössische Beleuchtungsoption, die über die Funktionalität hinausgeht und den Raum durch ihr künstlerisches Design verwandelt. Die Kombination aus lasergeschnittenem Metall und LED-Beleuchtung macht sie nicht nur zu einer Lichtquelle, sondern auch zu einem auffälligen dekorativen Element, das die Blicke auf sich zieht und jedem Raum eine besondere Note verleiht.



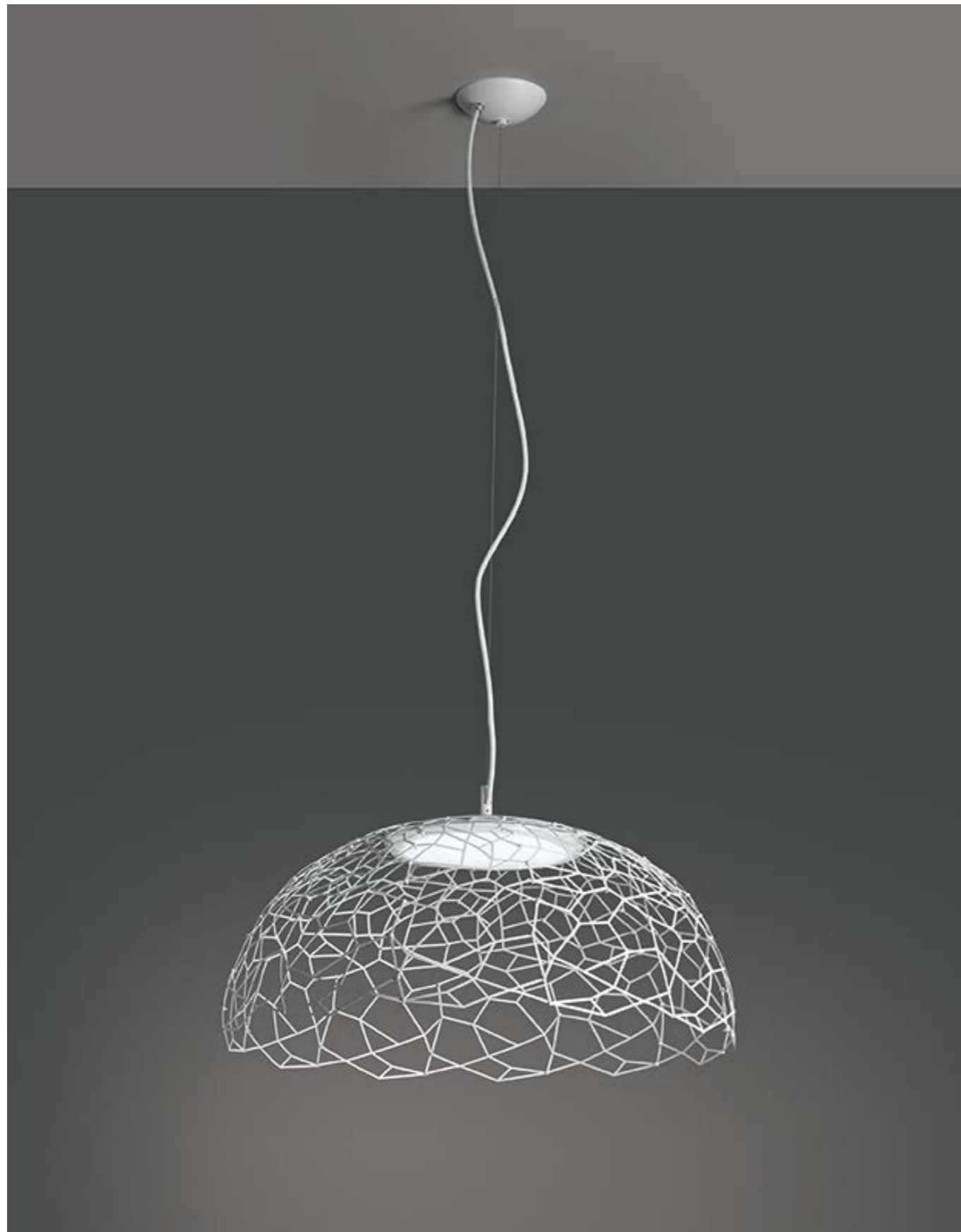

White

Sandy

Matt Black

864/60 S

LED 1x28W 230V
2700lm 3000°K upon request 2700°/4000°K

CE IP20

Net weight 2500gr - Gross weight 4900gr

Volume m³ 0,020

 PHASE-CUT DIMMING

864/80 S

LED 1x35W 230V

4000lm 3000°K upon request 2700°/4000°K

CE IP20

Net weight 4400gr - Gross weight 8700gr

Volume m³ 0,037

 PHASE-CUT DIMMING

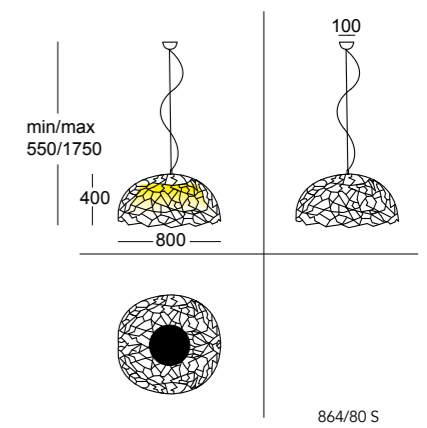
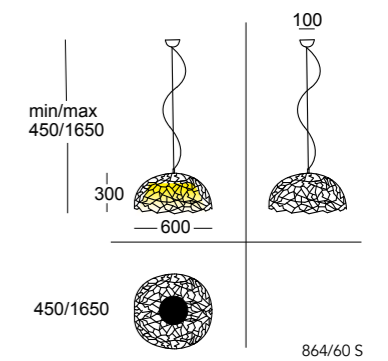



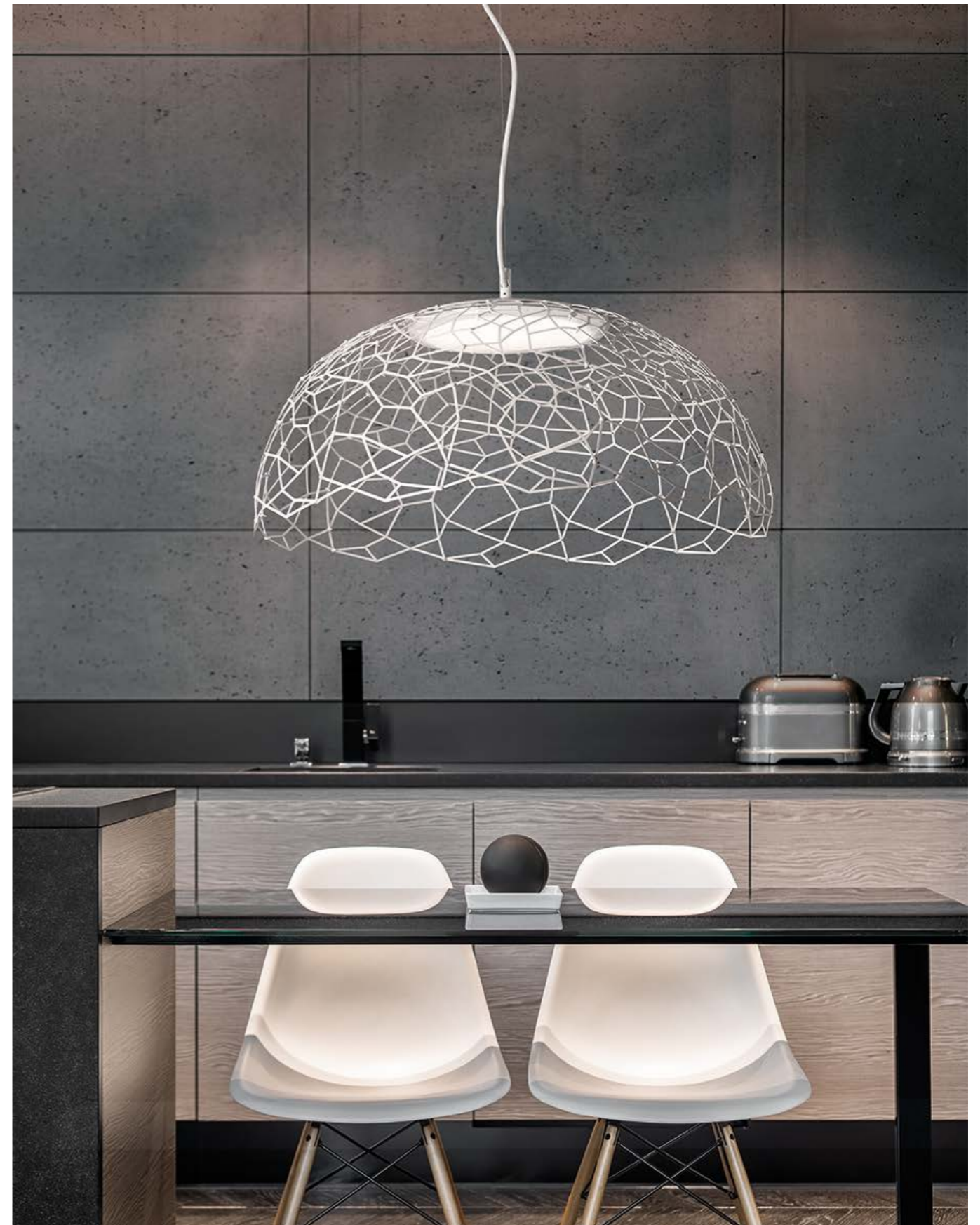
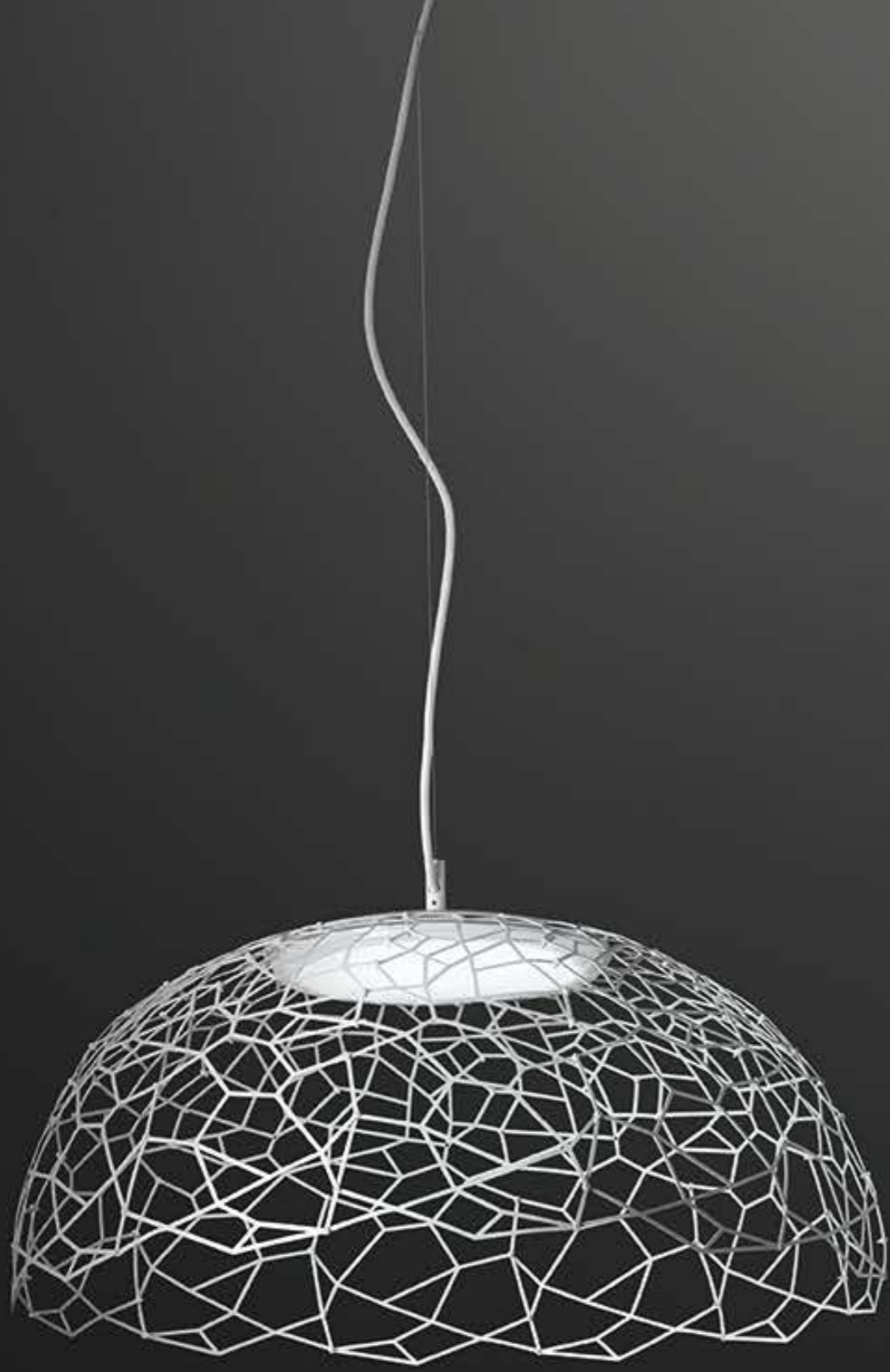

Basalt

design by C. Cattaneo

Una stratificazione di livelli geometrici costituisce la forma della lampada Basalt, plafoniera in grado di mimetizzarsi nello spazio ma allo stesso tempo di arricchirlo con una tridimensionalità inattesa. Concepita assemblando elementi geometrici primari, Basalt produce una luce indiretta e trasforma la superficie in cui viene installata in diffusore capace di illuminare lo spazio in modo omogeneo ed elegante, creando sempre un'atmosfera adatta ad ogni esigenza.

A stratification of geometrical layers makes up the shape of Basalt, a ceiling light able to camouflage itself in the space, but at the same time to enhance the environment with an unexpected three-dimensional effect. Basalt has been conceived assembling primary geometrical elements. It casts an indirect light that turns the surface into a diffuser able to illuminate the space homogeneously and gracefully, creating the perfect atmosphere for all needs.

Eine Schichtung geometrischer Ebenen bildet die Form der Basaltlampe, einer Deckenleuchte, die sich im Raum tarnen, aber gleichzeitig mit einer unerwarteten Dreidimensionalität bereichern kann. Basalt wurde durch die Montage von primären geometrischen Elementen entwickelt, erzeugt indirektes Licht und verwandelt die Oberfläche, in der es installiert ist, in einen Diffusor, der in der Lage ist, den Raum homogen und elegant zu beleuchten und immer eine für jeden Bedarf geeignete Atmosphäre zu schaffen.



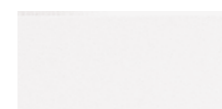
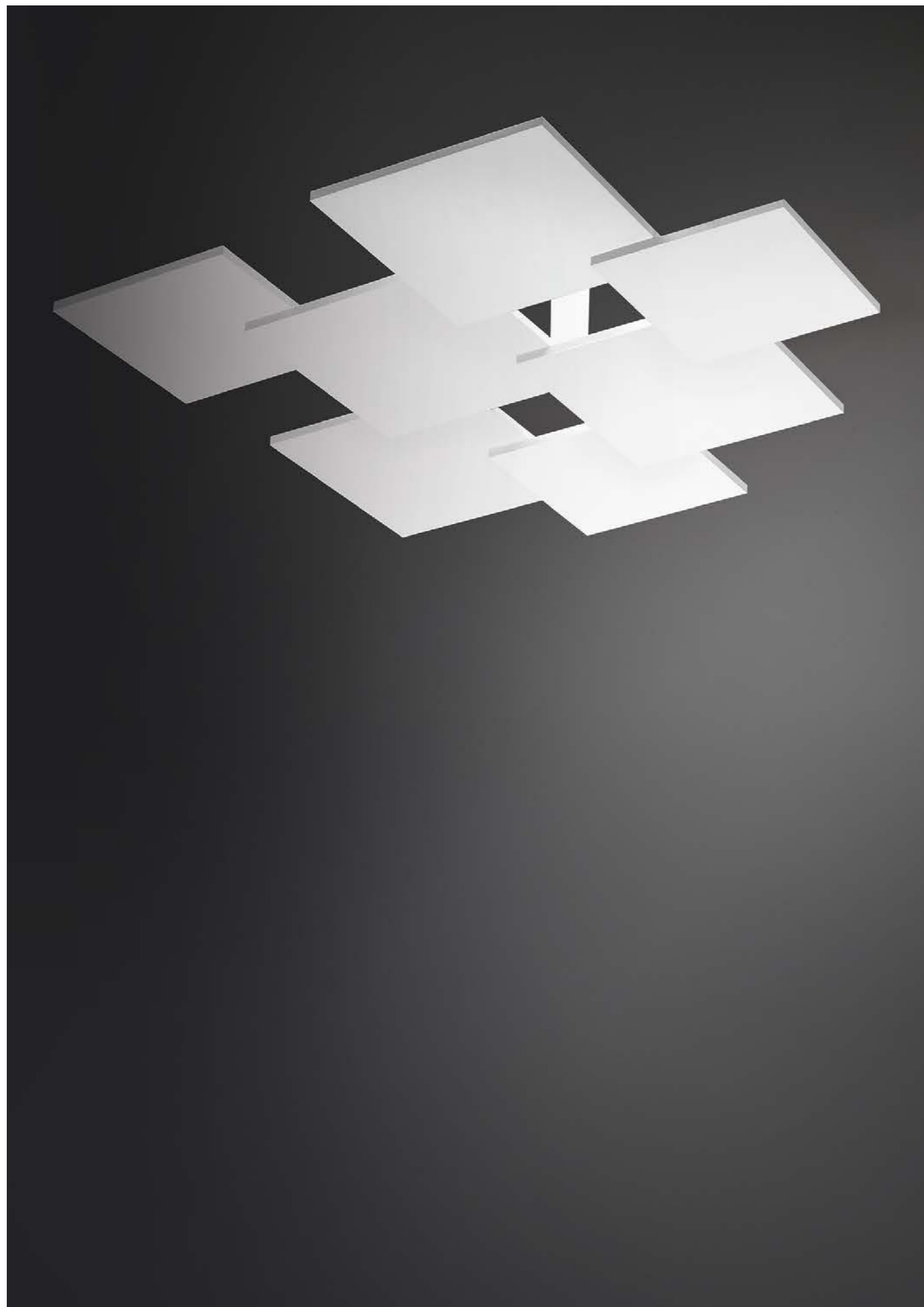

White

897/60 P

LED 3x17W 230V
4500lm 3000°K upon request 2700°/4000°K

CE  IP20

Net weight 3220gr - Gross weight 5700gr

Volume m³ 0,094

 PHASE-CUT DIMMING

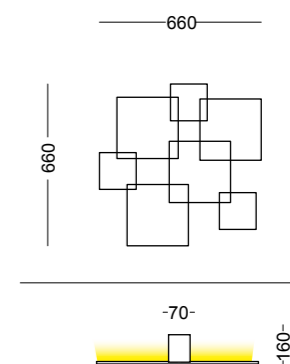



Ninfea

design by C. Cattaneo

Una sovrapposizione di forme curve compone questa lampada che, come le foglie di una ninfea, si appoggia leggera sulla superficie in cui viene installata. Ninfea emana una luce indiretta che illumina gli spazi con morbidezza creando dinamiche atmosfere chiaroscurali grazie alla possibilità di aumentare o diminuire l'intensità di luce emessa. La sua presenza non invasiva permette a Ninfea di dialogare con l'ambiente circostante divenendo parte integrante dell'interior design. Un prodotto con tecnologia led che coniuga qualità, design e artigianalità.

This light is made up of an overlapping of curved shapes that, as the leaves of a water lily, lean lightly into the surface on which they are installed. Ninfea releases an indirect light that enlightens the space with softness, creating dynamic light and dark atmospheres, thanks to the chance of increasing and decreasing the intensity of light. Its non-invasive presence, allows Ninfea to converse with the surrounding environment becoming integral part of the interior design. A product with LED technology combining quality, design and craftsmanship.

Eine Überlagerung von geschwungenen Formen bildet diese Lampe, die wie die Blätter einer Seerose leicht auf der Oberfläche liegt, auf der sie installiert ist. Ninfea emittiert ein indirektes Licht, das die Räume weich ausleuchtet und dank der Möglichkeit, die Intensität des emittierten Lichts zu erhöhen oder zu verringern, dynamische Hell-Dunkel-Atmosphären erzeugt. Seine nicht-invasive Präsenz ermöglicht es Ninfea, mit der Umgebung zu kommunizieren und wird so zu einem integralen Bestandteil der Innenarchitektur. Ein Produkt mit LED-Technologie, das Qualität, Design und Handwerk vereint.





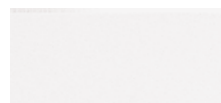
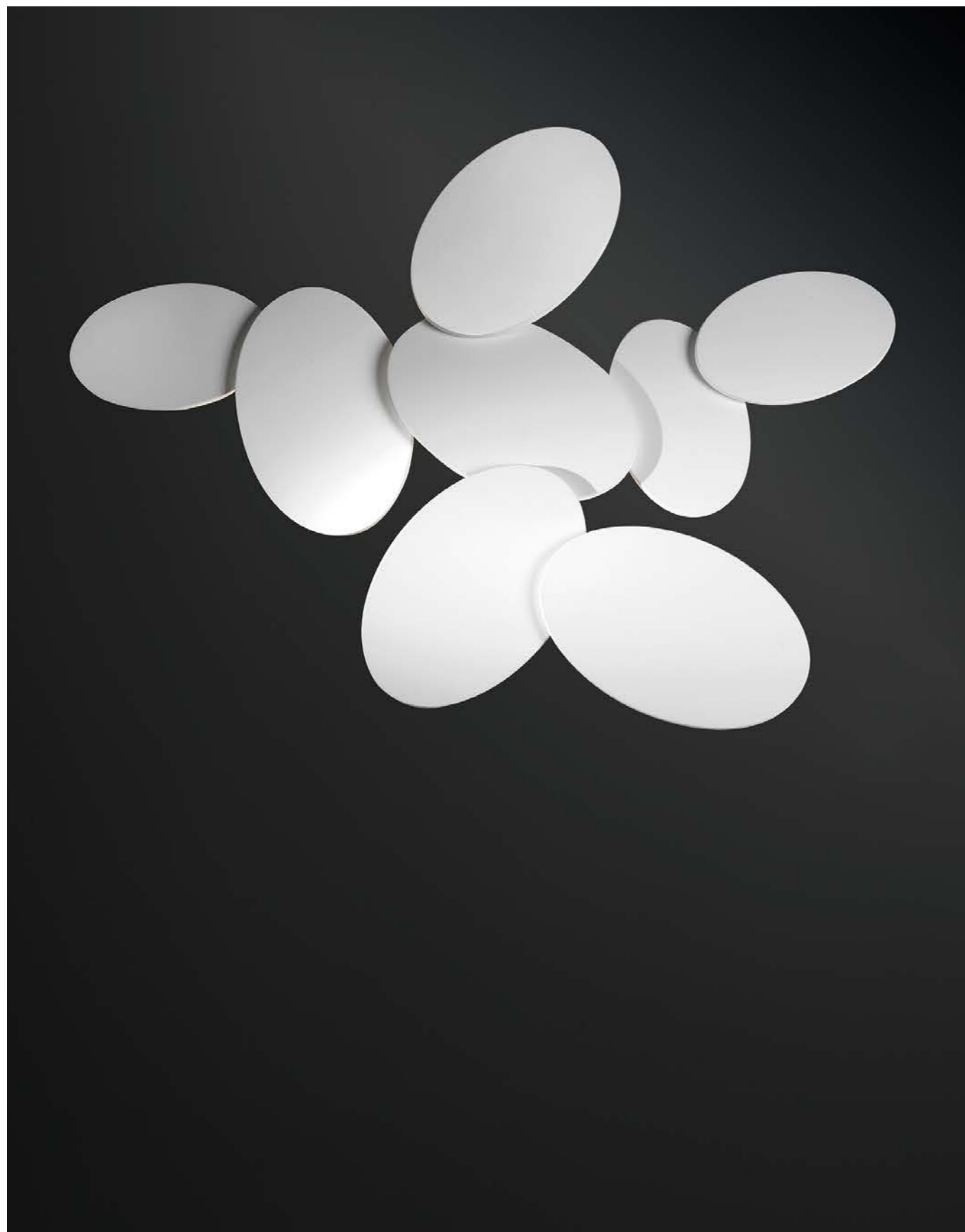



White



895/70 P

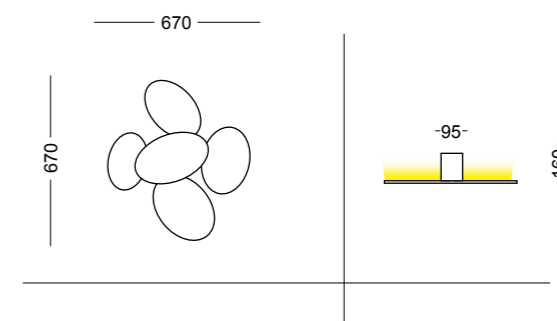

LED 2x17W 230V
 3000lm 3000°K upon request 2700°/4000°K
 Net weight 2868gr - Gross weight 4880gr
 Volume m³ 0,089

 PHASE-CUT DIMMING
 



895/90 P

LED 3x17W 230V
 4500lm 3000°K upon request 2700°/4000°K
 Net weight 4170gr - Gross weight 7600gr
 Volume m³ 0,174

 PHASE-CUT DIMMING
 

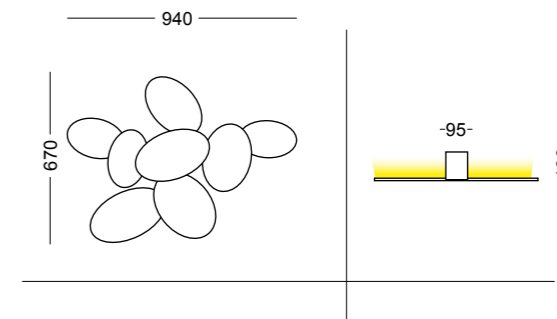

Mickey

design by L. Cristiani

La lampada "Mickey" incarna l'eleganza contemporanea con la sua fusione di forme circolari armoniose. Disponibile nelle versioni da parete, plafone e tavolo, questa lampada trasmette un'aura di modernità sofisticata in ogni ambiente.

L'elemento distintivo di "Mickey" risiede nella sua composizione di cerchi di diverse dimensioni, che si fondono armoniosamente per creare un'estetica unica e accattivante. Ogni cerchio si integra perfettamente con gli altri, formando un equilibrio visivo sorprendente che cattura l'attenzione e aggiunge un tocco di raffinatezza allo spazio circostante.

La versione da parete di "Mickey" offre un'eccellente soluzione di illuminazione per arricchire qualsiasi parete con stile e funzionalità. La versione da plafone aggiunge un tocco di modernità al soffitto, diffondendo una luce morbida e avvolgente nell'ambiente. Mentre la versione da tavolo offre una fonte di luce versatile e decorativa, perfetta per aggiungere un tocco di eleganza su qualsiasi superficie.

Realizzata con materiali di alta qualità e una meticolosa attenzione ai dettagli, la lampada "Mickey" rappresenta un'eccellente combinazione di forma e funzione, destinata a diventare il fulcro di attrazione in qualsiasi spazio moderno e raffinato.

The 'Mickey' lamp embodies contemporary elegance with its fusion of harmonious circular shapes. Available in wall, ceiling and table versions, this lamp conveys an aura of sophisticated modernity in any environment.

The distinctive element of 'Mickey' lies in its composition of circles of different sizes, which blend harmoniously to create a unique and captivating aesthetic. Each circle integrates perfectly with the others, forming a striking visual balance that catches the eye and adds a touch of sophistication to the surrounding space.

The wall version of 'Mickey' offers an excellent lighting solution to enrich any wall with style and functionality. The ceiling version adds a modern touch to the ceiling, diffusing a soft, enveloping light into the room. While the table version offers a versatile and decorative light source, perfect for adding a touch of elegance to any surface.

Made with high-quality materials and meticulous attention to detail, the 'Mickey' lamp is an excellent combination of form and function, destined to become the centre of attraction in any modern, refined space.

Die Leuchte "Mickey" verkörpert mit ihrer Verschmelzung von harmonischen Kreisformen zeitgenössische Eleganz. Erhältlich als Wand-, Decken- und Tischleuchte vermittelt sie in jeder Umgebung eine Aura von anspruchsvoller Modernität.

Die Besonderheit von Mickey" liegt in der Komposition von Kreisen unterschiedlicher Größe, die sich harmonisch zu einer einzigartigen und fesselnden Ästhetik verbinden. Jeder Kreis fügt sich perfekt in die anderen ein und bildet ein auffallendes visuelles Gleichgewicht, das die Aufmerksamkeit auf sich zieht und dem Raum einen Hauch von Raffinesse verleiht.

Die Wandversion von 'Mickey' bietet eine hervorragende Beleuchtungslösung, die jede Wand mit Stil und Funktionalität bereichert. Die Deckenversion verleiht der Decke einen modernen Touch und verbreitet ein weiches, umhüllendes Licht im Raum. Die Tischversion ist eine vielseitige und dekorative Lichtquelle, die jede Oberfläche mit einem Hauch von Eleganz versieht.

Die aus hochwertigen Materialien und mit viel Liebe zum Detail gefertigte Leuchte "Mickey" ist eine hervorragende Kombination aus Form und Funktion, die in jedem modernen und raffinierten Raum zum Mittelpunkt wird.





861/3 PA
 220-240V - 3 Gx53 LED
 Net weight 920gr
 Gross weight 1160gr
 Volume 0,018 m³
 Lamp supplied without bulbs
 CE IP20

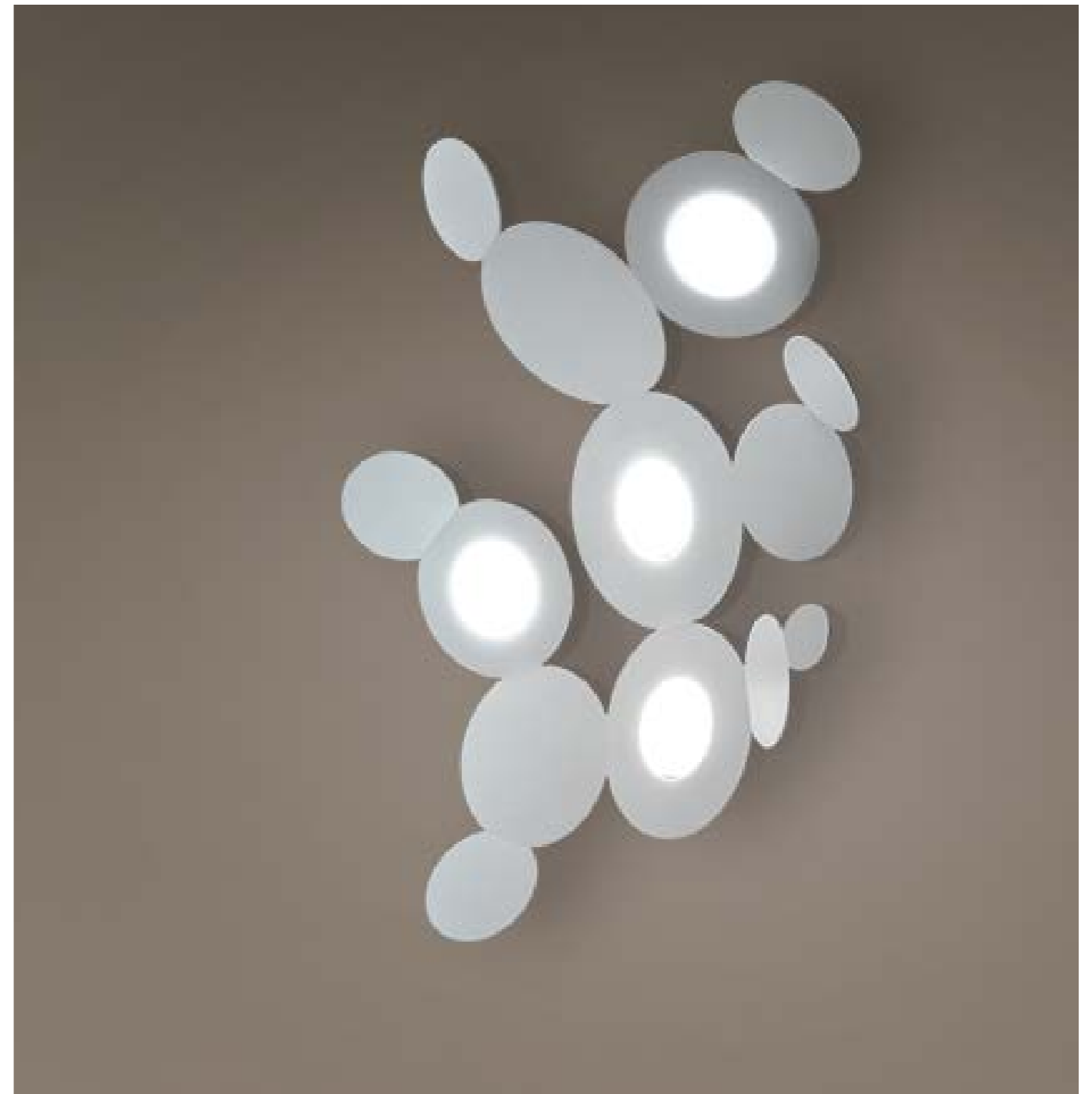
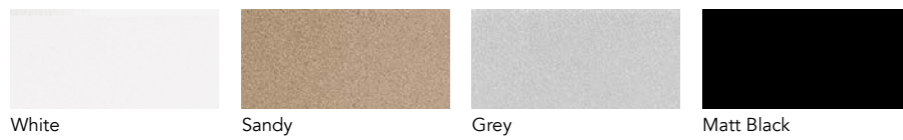
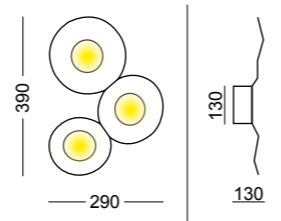

861/4 PA
 220-240V - 4 Gx53 LED
 Net weight 2200gr
 Gross weight 3500gr
 Volume 0,095 m³
 Lamp supplied without bulbs
 CE IP20

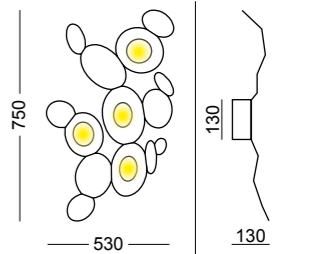

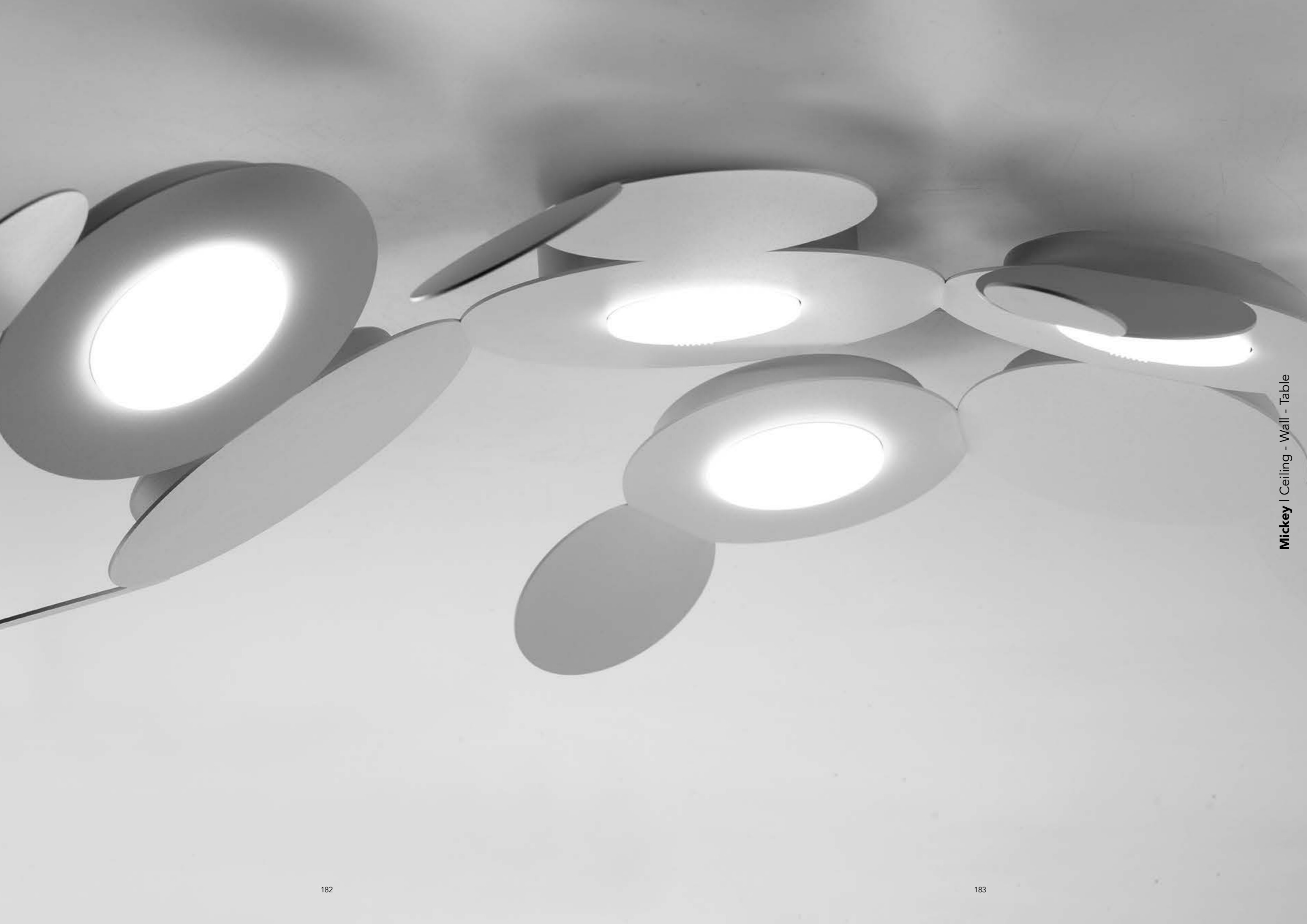



861/6 PA
 220-240V - 6 Gx53 LED
 Net Weight 2900gr
 Gross Weight 6700gr
 Volume 0,17 m³
 Lamp supplied without bulbs

CE IP20

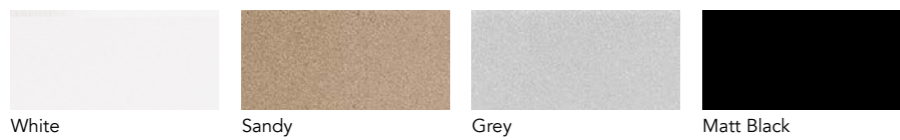
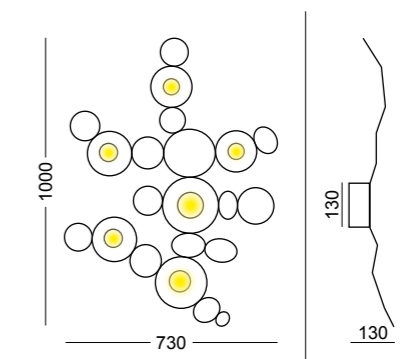

White

Sandy

Grey

Matt Black



Mickey | Ceiling - Wall - Table

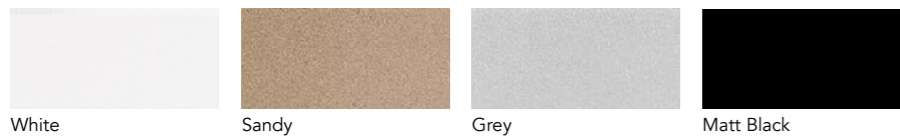

861/1PA
 220-240V - 1 Gx53 LED
 Net Weight 525gr
 Gross Weight 840gr
 Volume 0,0105 m³
 Lamp supplied without bulbs

CE IP20

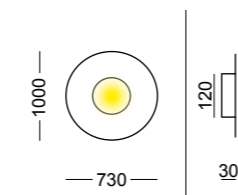

Mickey | Ceiling - Wall - Table





861/1 L
 220-240V - GX53 LED
 Net Weight 1426gr
 Gross Weight 1867gr
 Volume 0,024 m³
 Lamp supplied without bulbs

CE IP20

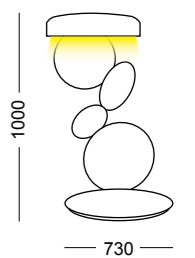

Biquadro

design by C. Cattaneo

Esplora l'equilibrio perfetto tra design innovativo e funzionalità versatile con la lampada a sospensione Biquadro. Caratterizzata da una forma quadrata elegante e minimalista, questa lampada è un'ode alla modernità e alla praticità. Realizzata con alluminio di alta qualità, la struttura della lampada Biquadro emana solidità e stile contemporaneo.

Ma ciò che la distingue è la sua parte centrale basculante, un'innovazione che permette di regolare la luce tra diretta e indiretta, offrendo una flessibilità luminosa senza pari. La lampada Biquadro offre una luce indiretta costante grazie ai LED posizionati nel bordo della parte non basculante. Questa luce soffusa contribuisce a creare un'atmosfera accogliente e avvolgente, anche quando la parte centrale è inclinata per fornire luce diretta. Quando inclinata verso il basso, la parte centrale della lampada consente una luce diretta, ideale per concentrare l'illuminazione su una zona specifica come un tavolo da pranzo o una scrivania.

Al contrario, quando inclinata verso l'alto, la lampada diffonde una luce indiretta supplementare, amplificando l'effetto avvolgente nell'ambiente circostante. La lampada a sospensione Biquadro non solo aggiunge un tocco di raffinatezza e modernità al tuo spazio, ma offre anche una soluzione luminosa adattabile alle tue esigenze e preferenze. Sia che tu stia cercando di illuminare una zona specifica o di creare un'atmosfera accogliente in tutta la stanza, Biquadro si rivela una scelta impeccabile per un design intelligente e una funzionalità senza compromessi.

Explore the perfect balance of innovative design and versatile functionality with the Biquadro pendant lamp. Characterised by an elegant and minimalist square shape, this lamp is an ode to modernity and practicality. Made of high-quality aluminium, the structure of the Biquadro lamp exudes solidity and contemporary style.

But what sets it apart is its pivoting central part, an innovation that allows the light to be adjusted between direct and indirect, offering unparalleled lighting flexibility. The Biquadro lamp offers constant indirect light thanks to LEDs positioned in the edge of the non-tilting part. This soft light contributes to a cosy, enveloping atmosphere, even when the central part is tilted to provide direct light. When tilted downwards, the central part of the lamp provides direct light, ideal for concentrating illumination on a specific area such as a dining table or desk.

Conversely, when tilted upwards, the lamp diffuses additional indirect light, amplifying the enveloping effect in the surroundings. Whether you are looking to illuminate a specific area or to create a cosy atmosphere in the whole room, Biquadro proves to be an impeccable choice for intelligent design and uncompromising functionality.

Entdecken Sie das perfekte Gleichgewicht aus innovativem Design und vielseitiger Funktionalität mit der Pendelleuchte Biquadro. Mit ihrer eleganten und minimalistischen quadratischen Form ist diese Leuchte eine Ode an die Modernität und Zweckmäßigkeit. Die aus hochwertigem Aluminium gefertigte Struktur der Biquadro-Lampe strahlt Solidität und zeitgenössischen Stil aus.

Das Besondere an dieser Leuchte ist der drehbare Mittelteil, eine Innovation, die es ermöglicht, das Licht zwischen direktem und indirektem Licht zu wechseln, was eine unvergleichliche Flexibilität bei der Beleuchtung bietet. Die Leuchte Biquadro bietet ein konstantes indirektes Licht dank der LEDs, die am Rand des nicht schwenkbaren Teils angebracht sind. Dieses weiche Licht trägt zu einer gemütlichen, einhüllenden Atmosphäre bei, auch wenn der mittlere Teil für direktes Licht gekippt wird. Wird der mittlere Teil der Leuchte nach unten gekippt, spendet er direktes Licht, das ideal ist, um die Beleuchtung auf einen bestimmten Bereich zu konzentrieren, z. B. auf einen Esstisch oder einen Schreibtisch.

Umgekehrt streut die Leuchte bei einer Neigung nach oben zusätzliches indirektes Licht und verstärkt so die umhüllende Wirkung in der Umgebung. Ganz gleich, ob Sie einen bestimmten Bereich beleuchten oder eine gemütliche Atmosphäre im ganzen Raum schaffen wollen, Biquadro erweist sich als eine tadellose Wahl für intelligentes Design und kompromisslose Funktionalität.





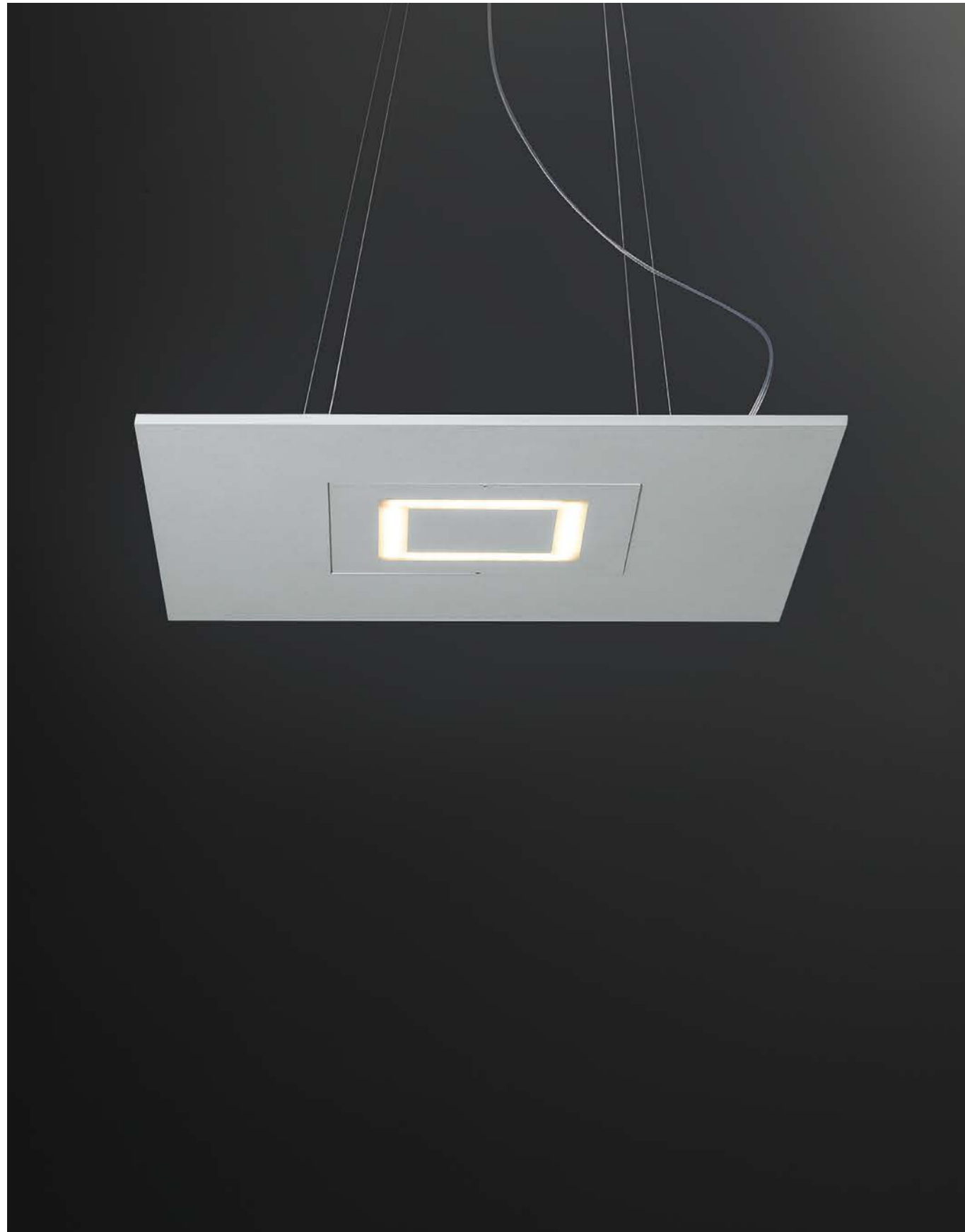

White

Sandy

Matt Black



879/60 S

LED 4x8W + 4x15W 230V

11200lm 3000°K upon request 2700°/4000°K

Net weight 7600gr - Gross weight 10500gr

Volume m³ 0,090

 PHASE CUT - DIMMING

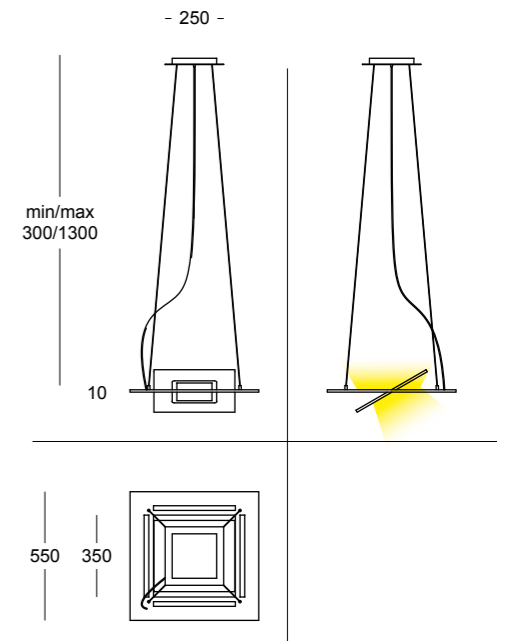

Centreline

design by C. Cattaneo

La lampada Centreline, disponibile sia per la parete che per il soffitto, presenta un design distintivo che unisce funzionalità ed estetica. La sua forma rettangolare è caratterizzata da un affascinante effetto di taglio di luce all'interno, che crea un'atmosfera unica nell'ambiente.

Con tre diverse lunghezze tra cui scegliere - 40 cm, 70 cm e 100 cm, la Centreline offre flessibilità nella personalizzazione, adattandosi alle dimensioni specifiche del tuo spazio. Ogni variante, con il suo design affascinante, aggiunge un tocco di modernità e stile alla tua area.

La sorgente luminosa della Centreline è progettata per la massima praticità. Facilmente smontabile e sostituibile, questa caratteristica non solo estende la durata della lampada, ma offre anche la possibilità di aggiornare la tecnologia luminosa senza dover sostituire l'intera lampada.

Disponibile in una selezione di colori, tra cui bianco, nero e sabbia, la Centreline si integra perfettamente con la tua estetica e l'arredamento circostante. Questo non è solo un elemento di illuminazione funzionale ma anche un dettaglio decorativo che cattura l'attenzione. La Centreline è la scelta ideale per chi cerca una combinazione di design moderno e praticità senza compromessi.

The Centreline lamp, available for both wall and ceiling, features a distinctive design that combines functionality and aesthetics. Its rectangular shape is characterised by a fascinating cut-out effect of light inside, which creates a unique atmosphere in the room.

With three different lengths to choose from - 40 cm, 70 cm and 100 cm - Centreline offers flexibility in customisation, adapting to the specific dimensions of your space. Each variant, with its fascinating design, adds a touch of modernity and style to your area.

Centreline's light source is designed for maximum practicality. Easily removable and replaceable, this feature not only extends the life of the lamp, but also offers the possibility of upgrading the light technology without having to replace the entire lamp.

Available in a selection of colours, including white, black and sandy, the Centreline blends perfectly with your aesthetic and surrounding décor. This is not only a functional lighting element but also an eye-catching decorative detail. Centreline is the ideal choice for those seeking a combination of modern design and uncompromising practicality.

Die Centreline-Leuchte, die sowohl für die Wand als auch für die Decke erhältlich ist, zeichnet sich durch ein unverwechselbares Design aus, das Funktionalität und Ästhetik vereint. Ihre rechteckige Form zeichnet sich durch einen faszinierenden Cut-out-Effekt des Lichts im Inneren aus, der eine einzigartige Atmosphäre im Raum schafft.

Mit drei verschiedenen Längen - 40 cm, 70 cm und 100 cm - bietet die Centreline Flexibilität bei der individuellen Gestaltung, die sich an die spezifischen Abmessungen Ihres Raumes anpasst. Jede Variante bringt mit ihrem faszinierenden Design einen Hauch von Modernität und Stil in Ihren Raum.

Die Lichtquelle der Centreline ist auf maximale Praktikabilität ausgelegt. Sie ist leicht herausnehmbar und austauschbar, was nicht nur die Lebensdauer der Leuchte verlängert, sondern auch die Möglichkeit bietet, die Lichttechnik aufzurüsten, ohne die gesamte Leuchte ersetzen zu müssen.

Die Centreline ist in verschiedenen Farben erhältlich, darunter Weiß, Schwarz und Sand, und fügt sich perfekt in Ihr ästhetisches Umfeld ein. Sie ist nicht nur ein funktionales Beleuchtungselement, sondern auch ein dekoratives Detail, das die Blicke auf sich zieht. Die Centreline ist die ideale Wahl für alle, die eine Kombination aus modernem Design und kompromissloser Zweckmäßigkeit suchen.



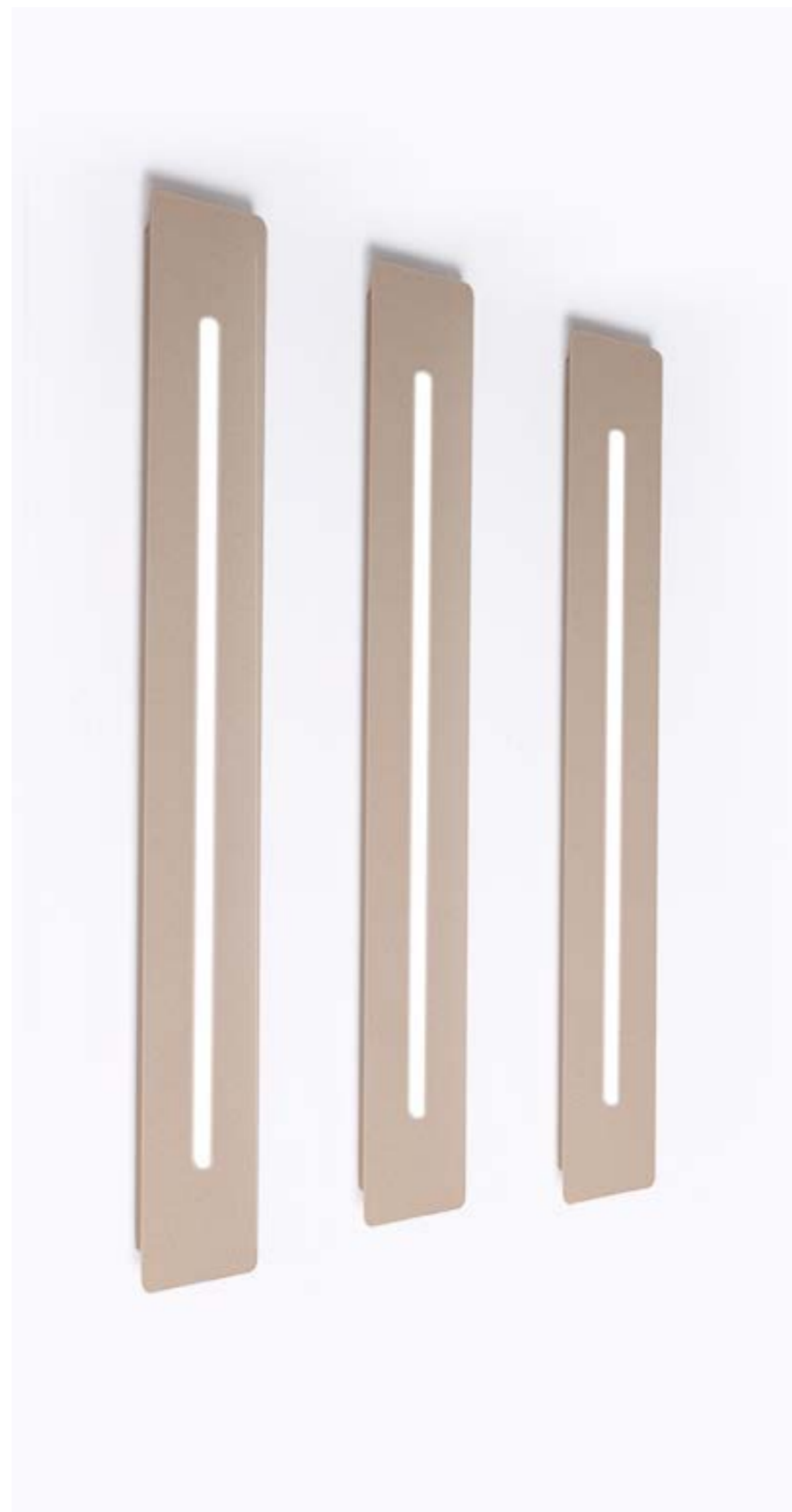

White

Sandy

Grey

890/40 PA

LED 1x15W - 230-240V - 2000lm. 3000° K

on request 2700-4000° K

Net weight 1300gr

Gross weight 1700gr

Volume 0,018 m³

 PHASE-CUT DIMMING

CE  IP20

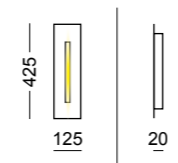

890/70 PA

LED 2x15W - 230-240V - 4000lm. 3000° K

on request 2700-4000° K

Net weight 2100gr

Gross weight 3050gr

Volume 0,021 m³

 PHASE-CUT DIMMING

CE  IP20

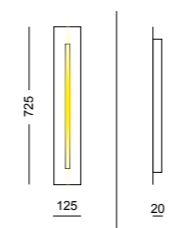

890/100 PA

LED 3x15W - 230-240V - 6000lm. 3000° K

on request 2700-4000° K

Net weight 3600gr

Gross weight 5400gr

Volume 0,021 m³

 PHASE-CUT DIMMING

CE  IP20

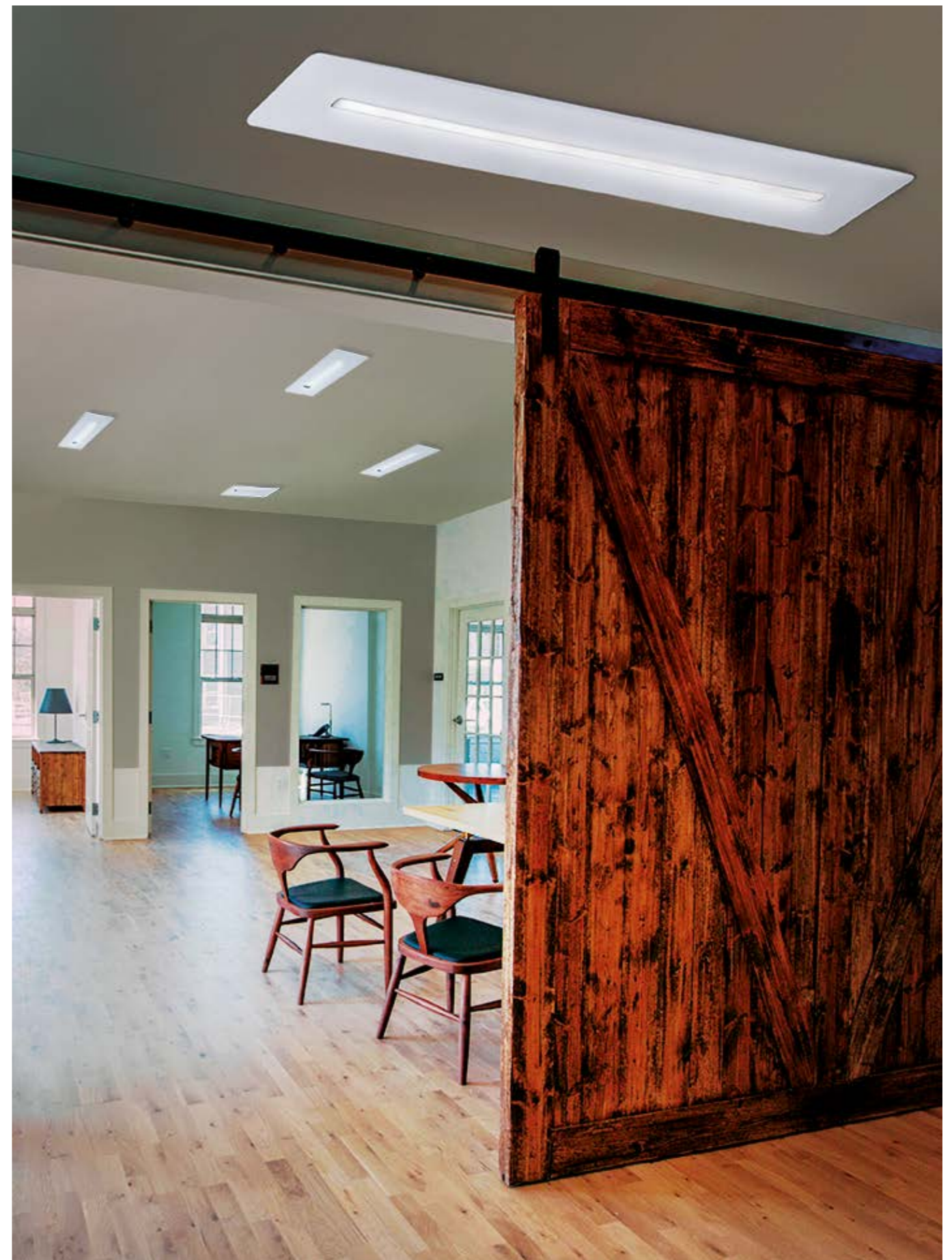
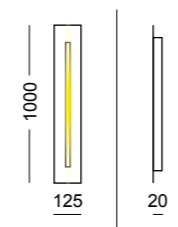

Centreline | Ceiling - Wall

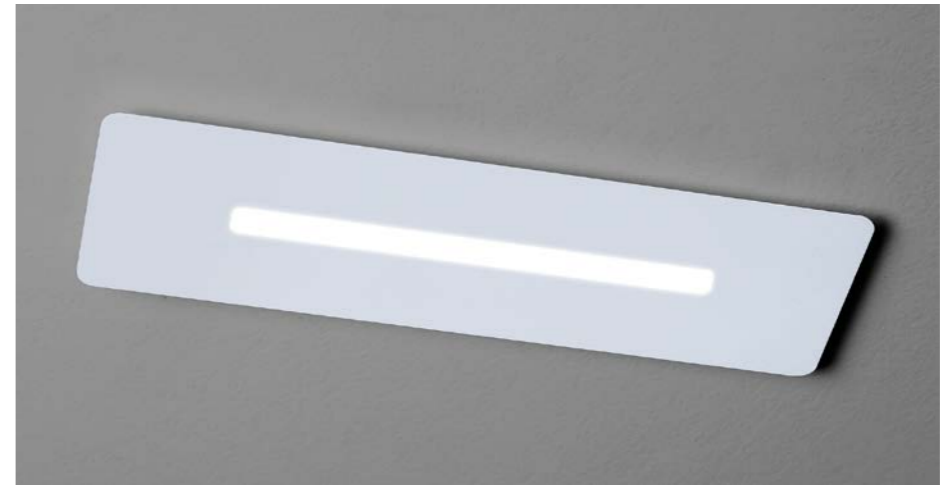

Sistema a incastro per un semplice collegamento e sostituzione LED

Magnetic system for a simple LED connection and replacement

Magnetisches System für eine einfache LED-Anschluss und -Austausch

Sesamo

design by C. Cattaneo

La lampada Sesamo da parete non è solo un'eccellenza di design, ma anche una soluzione pratica e personalizzabile. Realizzata in metallo di alta qualità, questa lampada rettangolare moderna è caratterizzata da due alette apribili e orientabili in altezza, offrendo una flessibilità senza precedenti nella regolazione della direzione della luce.

Il suo stile contemporaneo si combina perfettamente con l'innovazione funzionale.

La lampada Sesamo è dotata di una sorgente luminosa a LED, che non solo offre un'illuminazione efficiente ed ecologica, ma è anche completamente dimmerabile.

Questa caratteristica consente di regolare l'intensità della luce per creare l'atmosfera desiderata in ogni momento.

Ma le sorprese non finiscono qui: Sesamo è progettata per la massima praticità. La sorgente luminosa è facilmente smontabile, consentendo una sostituzione agevole del LED. Questa caratteristica non solo estende la durata della lampada, ma offre anche la possibilità di aggiornare la tecnologia LED senza dover sostituire l'intera lampada.

Inoltre, Sesamo è disponibile in tre eleganti colori: bianco, sabbia e grigio. Queste opzioni di colore permettono di personalizzare la lampada in base al tuo stile e all'arredamento circostante, garantendo che si integri armoniosamente in qualsiasi ambiente. In questo modo, Sesamo da parete non è solo una fonte di luce raffinata, ma anche un investimento a lungo termine che si adatta alle evoluzioni tecnologiche, garantendo sempre un'illuminazione all'avanguardia con una manutenzione facile e intuitiva.

Sesamo wall lamp is not only a design excellence, but also a practical and customisable solution. Made of high-quality metal, this modern rectangular lamp features two fins that can be opened and swivelled in height, offering unprecedented flexibility in adjusting the direction of light.

Its contemporary style is perfectly combined with functional innovation. The Sesamo is equipped with an LED light source, which not only offers efficient and environmentally friendly lighting, but is also fully dimmable. This feature allows the light intensity to be adjusted to create the desired atmosphere at any time.

But the surprises don't end there: Sesamo is designed for maximum practicality. The light source is easily removable, allowing the LED to be easily replaced. This feature not only extends the life of the lamp, but also offers the possibility of upgrading the LED technology without having to replace the entire lamp.

In addition, Sesamo is available in three elegant colours: white, sandy and grey. These colour options allow you to customise the lamp to suit your style and surrounding décor, ensuring that it blends harmoniously into any environment. In this way, Sesamo wall light is not only a refined light source, but also a long-term investment that adapts to technological evolutions, always guaranteeing state-of-the-art lighting with easy and intuitive maintenance.

Die Wandleuchte Sesamo ist nicht nur ein Designerstück, sondern auch eine praktische und anpassungsfähige Lösung. Diese moderne, rechteckige Leuchte aus hochwertigem Metall verfügt über zwei Lamellen, die geöffnet und in der Höhe geschwenkt werden können und so eine noch nie dagewesene Flexibilität bei der Einstellung der Lichtrichtung bieten.

Ihr zeitgenössischer Stil ist perfekt mit funktioneller Innovation kombiniert. Die Leuchte Sesamo ist mit einer LED-Lichtquelle ausgestattet, die nicht nur eine effiziente und umweltfreundliche Beleuchtung bietet, sondern auch vollständig dimmbar ist. So können Sie die Intensität des Lichts jederzeit an die gewünschte Atmosphäre anpassen.

Doch damit nicht genug der Überraschungen: Sesamo ist auf maximale Praktikabilität ausgelegt. Die Lichtquelle ist leicht abnehmbar, so dass die LED leicht ausgetauscht werden kann. Diese Eigenschaft verlängert nicht nur die Lebensdauer der Leuchte, sondern bietet auch die Möglichkeit, die LED-Technologie aufzurüsten, ohne die gesamte Leuchte ersetzen zu müssen.

Darüber hinaus ist Sesamo in drei eleganten Farben erhältlich: Weiß, Sand und Grau. Mit diesen Farboptionen können Sie die Leuchte individuell an Ihren Stil und Ihre Umgebung anpassen, so dass sie sich harmonisch in jede Umgebung einfügt. Auf diese Weise ist die Wandleuchte Sesamo nicht nur eine raffinierte Lichtquelle, sondern auch eine langfristige Investition, die sich an die technologische Entwicklung anpasst und stets eine moderne Beleuchtung mit einfacher und intuitiver Wartung garantiert.



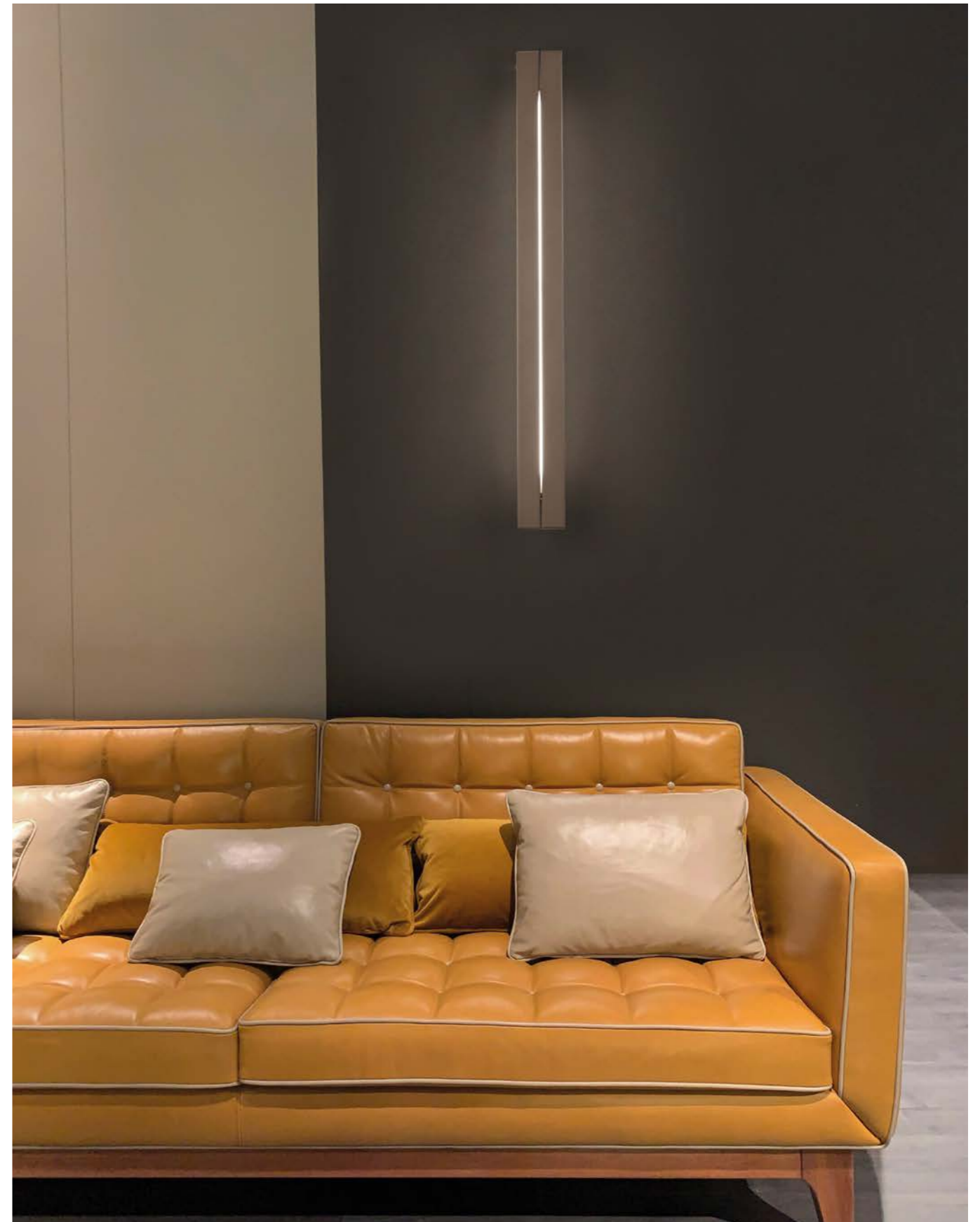

836/35 PA

LED 1x15W - 230-240V - 2000lm - 3000°K
on request 2700-4000° K
Net weight 850gr
Gross weight 1250gr
Volume 0,018 m³

 PHASE-CUT DIMMING

  IP20

836/67 PA

LED 2x15W - 230-240V - 4000lm - 3000°K
on request 2700-4000° K
Net weight 1450gr
Gross weight 1850gr
Volume 0,014 m³

 PHASE-CUT DIMMING

  IP20

836/95 PA

LED 3x15W - 230-240V - 6000lm - 3000°K
on request 2700-4000° K
Net weight 2000gr
Gross weight 2900gr
Volume 0,022 m³

 PHASE-CUT DIMMING

  IP20

836/125 PA

LED 4x15W - 230-240V - 8000lm - 3000°K
on request 2700-4000° K
Net weight 2500gr
Gross weight 3950gr
Volume 0,047 m³

 PHASE-CUT DIMMING

  IP20

836/155 PA

LED 5x15W - 230-240V - 10000lm - 3000°K
on request 2700-4000° K
Net weight 3000gr
Gross weight 4550gr
Volume 0,039 m³

 PHASE-CUT DIMMING

  IP20

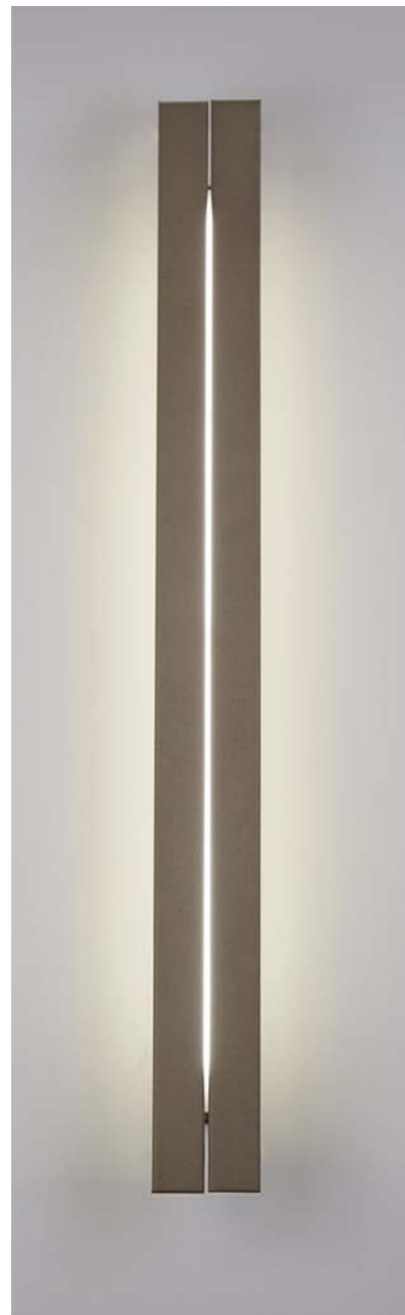
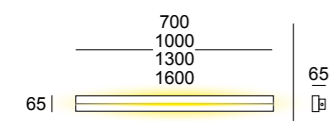

Sistema magnetico per un semplice collegamento e sostituzione LED

Magnetic system for a simple LED connection and replacement

Magnetisches System für eine einfache LED-Anschluss und -Austausch

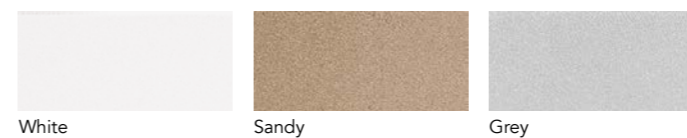
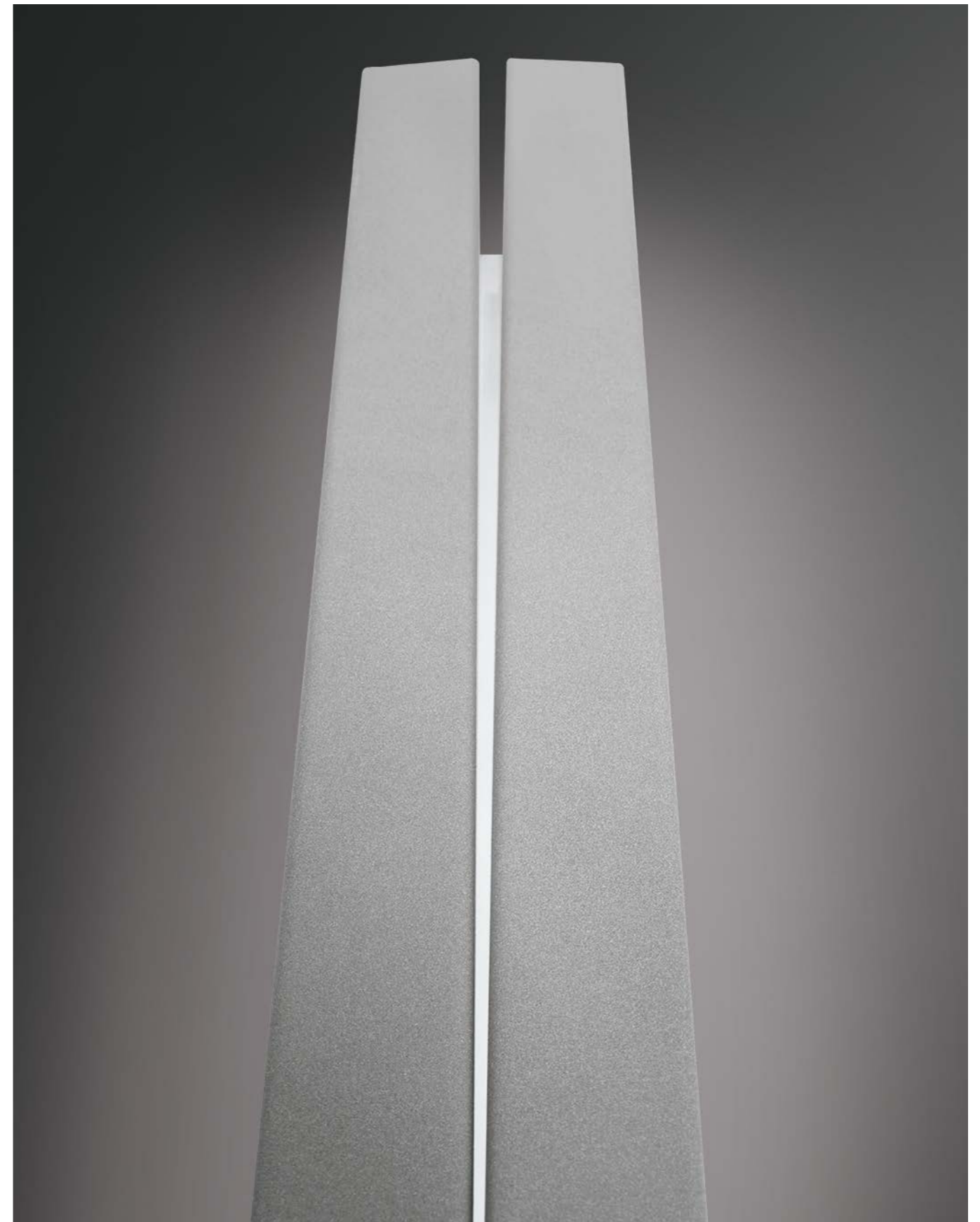



Abbraccio

design by C. Cattaneo

Abbraccio è più di una semplice lampada a parete; è un'affettuosa espressione di illuminazione lineare. Con la sua forma rettangolare, questa lampada abbraccia lo spazio con eleganza e funzionalità. Offrendo luce diretta e indiretta, crea atmosfere accoglienti e personalizzate. La sua installazione è un gioco da ragazzi grazie alla cover magnetica, rendendo l'esperienza ancora più avvolgente. Con Abbraccio, l'illuminazione diventa un gesto amorevole che trasforma ogni ambiente in un abbraccio luminoso.

Abbraccio is more than just a wall lamp; it is an affectionate expression of linear lighting. With its rectangular shape, this lamp embraces space with elegance and functionality. Offering direct and indirect light, it creates cosy and personalised atmospheres. Its installation is child's play thanks to the magnetic cover, making the experience even more enveloping. With Abbraccio, lighting becomes a loving gesture that transforms any room into a luminous embrace.

Abbraccio ist mehr als nur eine Wandleuchte, sie ist ein liebevoller Ausdruck von linearer Beleuchtung. Mit ihrer rechteckigen Form umarmt diese Leuchte den Raum mit Eleganz und Funktionalität. Mit direktem und indirektem Licht schafft sie gemütliche und persönliche Atmosphären. Die Installation ist dank der magnetischen Abdeckung ein Kinderspiel und macht das Erlebnis noch einladender. Mit Abbraccio wird die Beleuchtung zu einer liebevollen Geste, die jeden Raum in eine leuchtende Umarmung verwandelt.



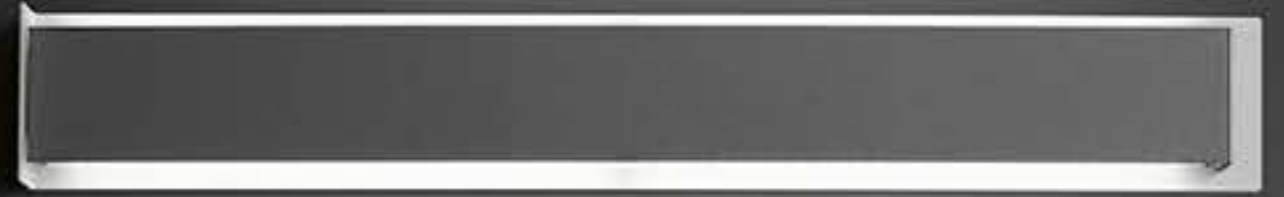



770/21 A
 LED 2x6W 24V Dc 220 - 240V
 1600lm 3000°K upon request 2700°/4000°K
 Net weight 710gr - Gross weight 880gr
 Volume m³ 0,0047
 CE IP20

770/36 A
 LED 2x12W 24V Dc 220 - 240V
 3200lm 3000°K upon request 2700°/4000°K
 Net weight 1150gr - Gross weight 1600gr
 Volume m³ 0,050
 CE IP20

770/70 A
 LED 4x12W 24V Dc 220 - 240V
 6400lm 3000°K upon request 2700°/4000°K
 Net weight 2150gr - Gross weight 2570gr
 Volume m³ 0,012
 CE IP20

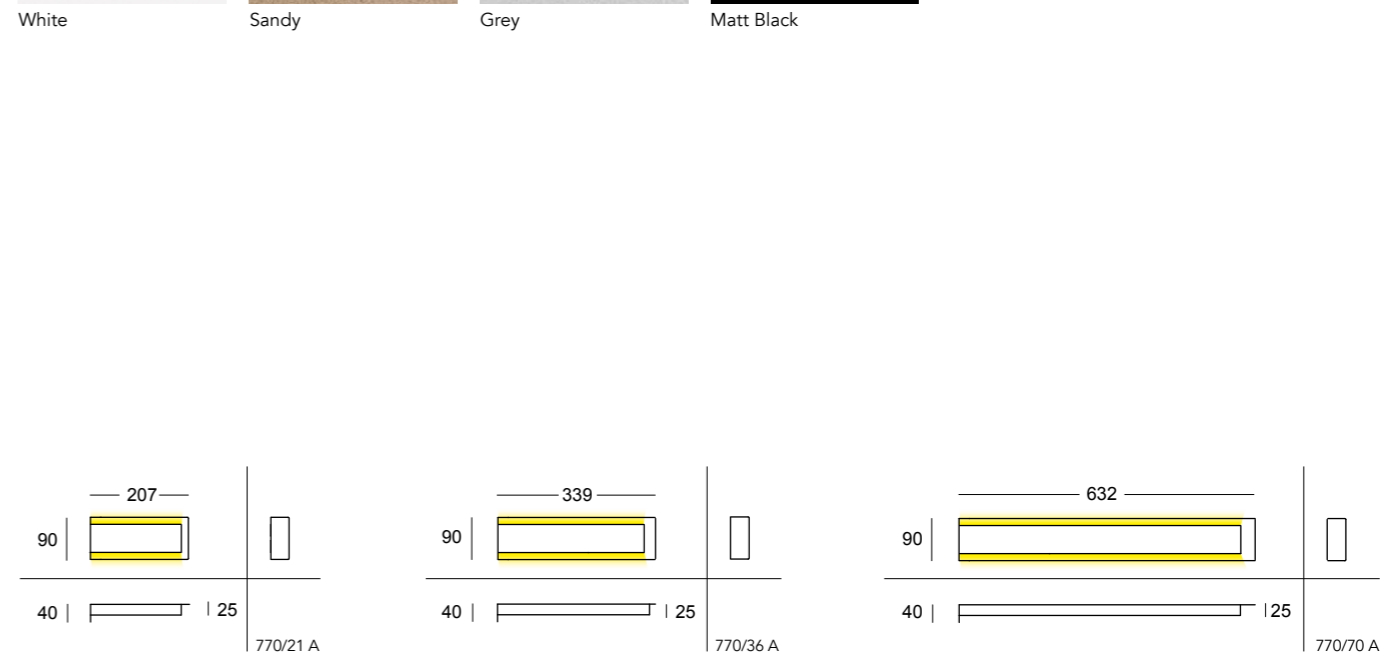
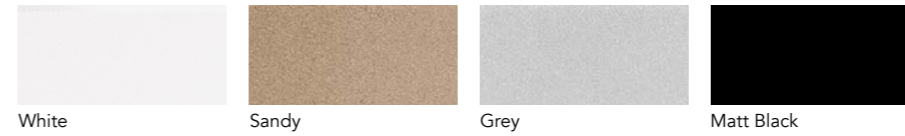

Abbraccio | Wall

Quadretto

design by E. Giudici

Nell'intersezione tra forma e funzionalità, la lampada a parete modello Quadretto si erge come un'opera d'arte illuminata, capace di plasmare lo spazio con eleganza e stile. Composta da due corpi quadrati sovrapposti e orientabili, questa lampada non solo offre una fonte di luce affidabile ma crea anche giochi scenografici che catturano l'immaginazione.

La sua struttura geometrica riflette un equilibrio armonico tra linee pulite e design contemporaneo. Ogni quadrato può essere ruotato indipendentemente, consentendo una flessibilità senza pari nell'orientare e modellare la luce.

Questa caratteristica unica permette di creare suggestivi giochi di ombre e luci che trasformano l'ambiente circostante in una scena teatrale.

La lampada Quadretto si adatta perfettamente a una varietà di ambienti, dalla sala da pranzo al salotto, dall'ufficio alla camera da letto. La sua versatilità consente di personalizzare l'illuminazione in base alle esigenze e alle preferenze individuali, creando un'atmosfera unica e accogliente in ogni situazione.

Grazie alla sua forma modulare e alla capacità di orientare i corpi luminosi, questa lampada diventa non solo una fonte di luce, ma anche un elemento decorativo che aggiunge profondità e carattere agli spazi che abbellisce.

At the intersection of form and function, the Quadretto model wall lamp stands as an illuminated work of art, capable of shaping space with elegance and style. Consisting of two overlapping, adjustable square bodies, this lamp not only offers a reliable source of light but also creates scenic effects that capture the imagination.

Its geometric structure reflects a harmonious balance of clean lines and contemporary design. Each square can be rotated independently, allowing unparalleled flexibility in directing and shaping the light.

This unique feature makes it possible to create striking plays of light and shadow that transform the surroundings into a theatrical scene.

The Quadretto lamp adapts perfectly to a variety of environments, from the dining room to the living room, from the office to the bedroom.

Its versatility allows the lighting to be customised to suit individual needs and preferences, creating a unique and welcoming atmosphere in every situation.

Thanks to its modular shape and the ability to direct the light bodies, this lamp becomes not only a source of light, but also a decorative element that adds depth and character to the spaces it beautifies.

Am Schnittpunkt von Form und Funktion steht die Wandleuchte Modell Quadretto als beleuchtetes Kunstwerk, das den Raum mit Eleganz und Stil zu gestalten vermag. Bestehend aus zwei sich überlappenden, verstellbaren quadratischen Körpern, bietet diese Leuchte nicht nur eine zuverlässige Lichtquelle, sondern erzeugt auch szenische Effekte, die die Fantasie anregen.

Ihre geometrische Struktur spiegelt ein harmonisches Gleichgewicht aus klaren Linien und modernem Design wider. Jedes Quadrat kann unabhängig voneinander gedreht werden, was eine unvergleichliche Flexibilität bei der Ausrichtung und Gestaltung des Lichts ermöglicht. Dank dieser einzigartigen Eigenschaft lassen sich beeindruckende Licht- und Schattenspiele erzeugen, die die Umgebung in eine theatrale Szene verwandeln.

Die Leuchte Quadretto passt sich perfekt an eine Vielzahl von Umgebungen an, vom Esszimmer bis zum Wohnzimmer, vom Büro bis zum Schlafzimmer. Dank ihrer Vielseitigkeit lässt sich die Beleuchtung an die individuellen Bedürfnisse und Vorlieben anpassen und schafft in jeder Situation eine einzigartige und einladende Atmosphäre.

Dank ihrer modularen Form und der Möglichkeit, die Lichtkörper zu richten, wird diese Leuchte nicht nur zu einer Lichtquelle, sondern auch zu einem dekorativen Element, das den Räumen, die sie verschönert, Tiefe und Charakter verleiht.



lampada | sospensione



White

Sandy

Grey



761/10 A

LED 4x2,2W 350mA 220 - 240V
 960lm 3000°K upon request 2700°/4000°K
 Net weight 640gr - Gross weight 850gr
 Volume m³ 0,0047

CE IP20

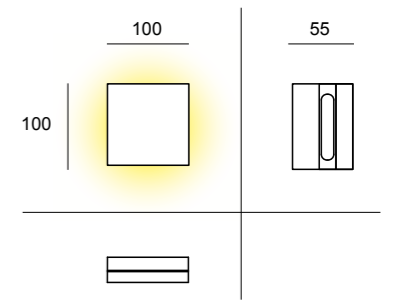

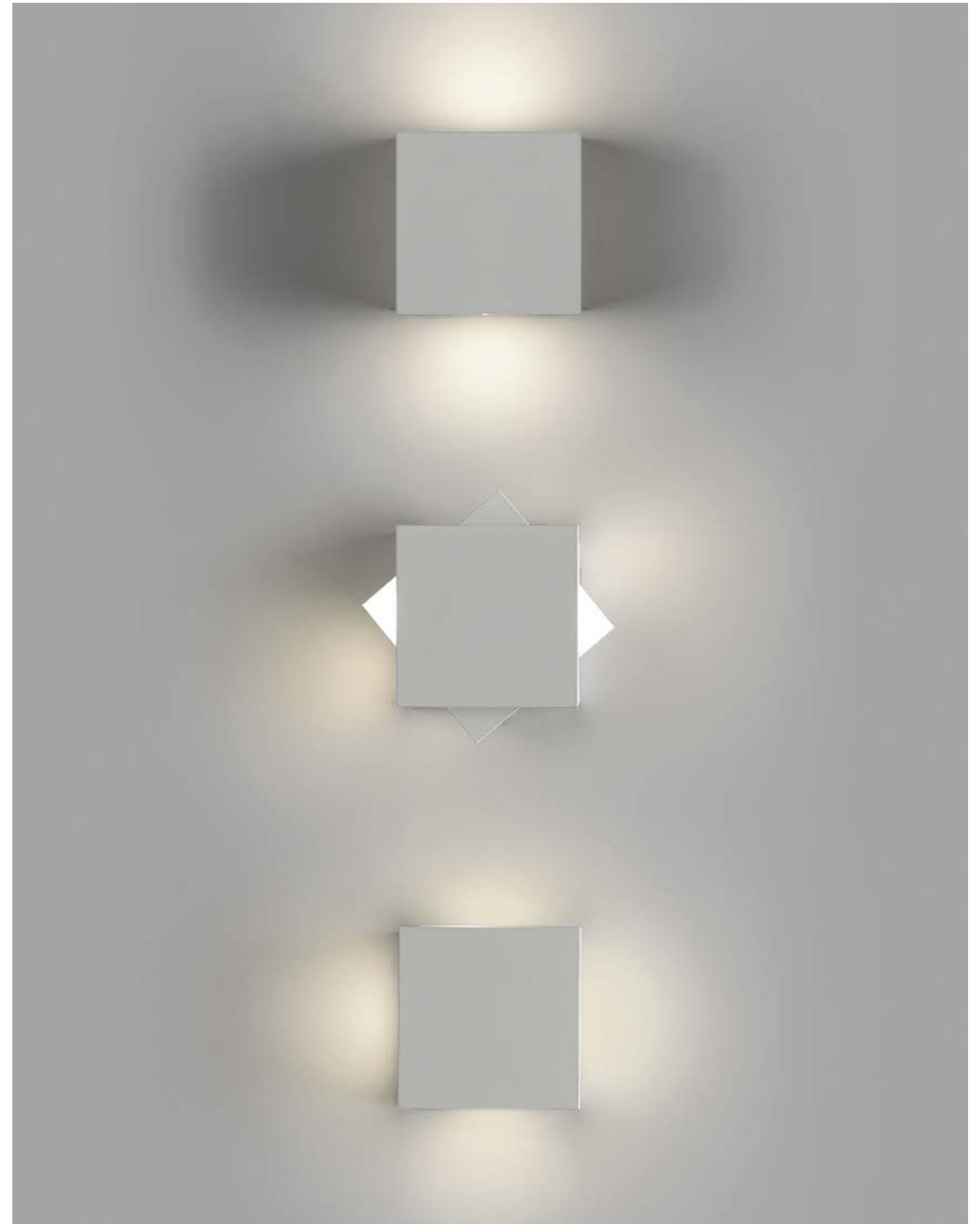
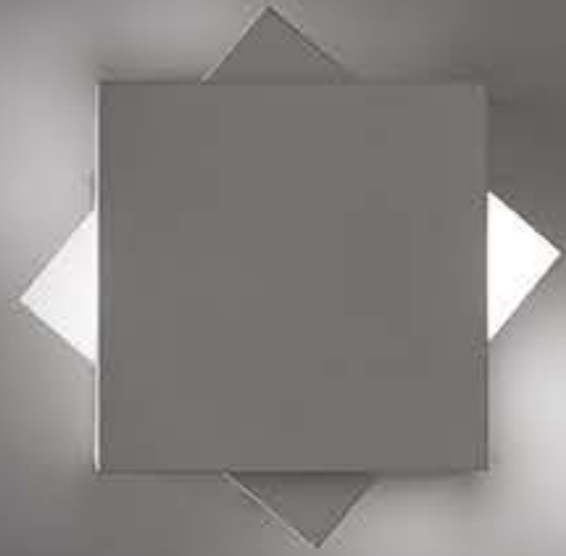

Cubick

design by C. Cattaneo

Lampada da parete, sospensione, plafone e tavolo in metallo verniciato in diversi colori. Dal design essenziale i modelli biemissione e monomissione a parete permettono una diversa illuminazione dell'ambiente. Da oggi la versione mono emissione a parete viene integrata da un meccanismo che consente di ruotare la lampada a seconda delle esigenze funzionali.

Wall lights, pendant lights, ceiling lights and table lights in metal, painted in several finishes. With an essential design, double and mono emission models give the chance to enlighten the environment in different ways. The mono emission variation has now been equipped with a mechanism that allows to rotate the fitting according to any functional need.

Wandlampe, Hängelampe, Deckenleuchte und Tischleuchte aus lackiertem Metall in verschiedenen Farben. Mit ihrem wesentlichen Design ermöglichen die Modelle Bi-emission und Wandaufbau Monomission eine unterschiedliche Umgebungsbeleuchtung. Ab sofort wird die Single-Emissions-Wandversion durch einen Mechanismus ergänzt, mit dem Sie die Lampe nach funktionalen Bedürfnissen drehen können.







White

Sandy

Grey

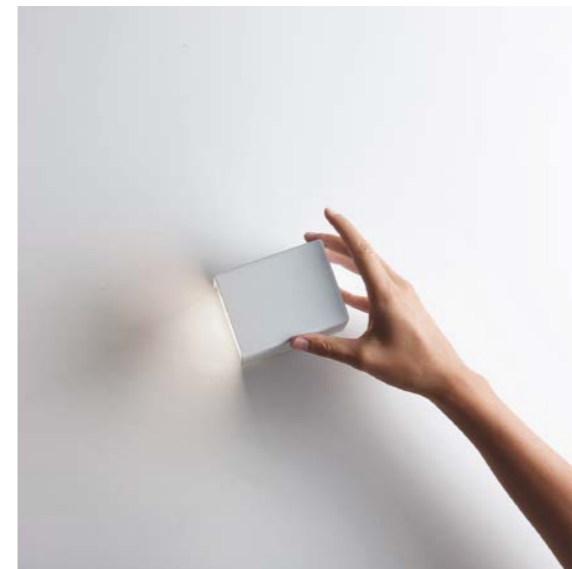

899/5 A

LED 1×4,5W 230V
 380lm 3000°K upon request 2700°/4000°K
 Net weight 290gr - Gross weight 470gr
 Volume m³ 0,0047

 PHASE-CUT DIMMING

  IP20

899/7 A

LED 1×8,7W 230V
 740lm 3000°K upon request 2700°/4000°K
 Net weight 470gr - Gross weight 650gr
 Volume m³ 0,0047

 PHASE-CUT DIMMING

  IP20



899/9 A

LED 1×13W 230V
 1140lm 3000°K upon request 2700°/4000°K
 Net weight 660gr - Gross weight 960gr
 Volume m³ 0,0090

 PHASE-CUT DIMMING

  IP20

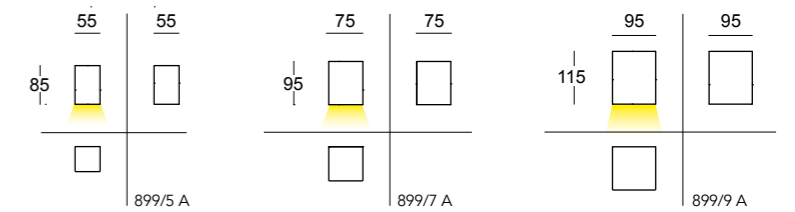

899/5 A

899/7 A

899/9 A



White

Sandy

Grey

767/5 A

LED 2×4,5W 230V
 760lm 3000°K upon request 2700°/4000°K
 Net weight 300gr - Gross weight 490gr
 Volume m³ 0,0047

 PHASE-CUT DIMMING

  IP20

767/7 A

LED 2×8,7W 230V
 1480lm 3000°K upon request 2700°/4000°K
 Net weight 490gr - Gross weight 670gr
 Volume m³ 0,0047

 PHASE-CUT DIMMING

  IP20

767/9 A

LED 2×13W 230V
 2280lm 3000°K upon request 2700°/4000°K
 Net weight 820gr - Gross weight 1060gr
 Volume m³ 0,0090

 PHASE-CUT DIMMING

  IP20

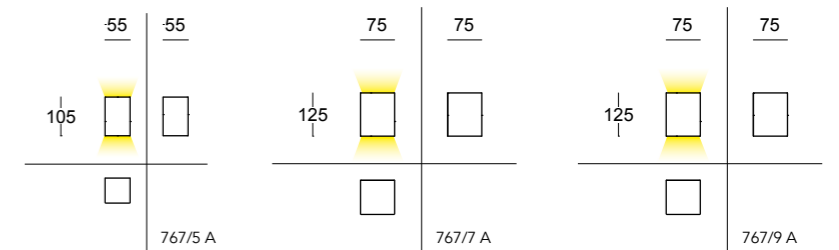

767/5 A

767/7 A

767/9 A



768/5 P

LED 1x4,5W 230V
 380lm - 3000°K upon request 2700°/4000°K
 Net weight 190gr - Gross weight 380gr
 Volume m³ 0,0047
 Dimmable PHASE-CUT DIMMING
 CE IP20

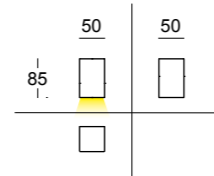

768/7 P

LED 1x8,7W 230V
 740lm - 3000°K upon request 2700°/4000°K
 Net weight 330gr - Gross weight 510gr
 Volume m³ 0,0047
 Dimmable PHASE-CUT DIMMING
 CE IP20

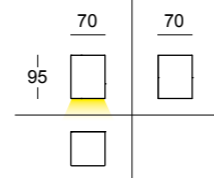

768/9 P

LED 1x13W 230V
 1140lm - 3000°K upon request 2700°/4000°K
 Net weight 570gr - Gross weight 870gr
 Volume m³ 0,0090
 Dimmable PHASE-CUT DIMMING
 CE IP20

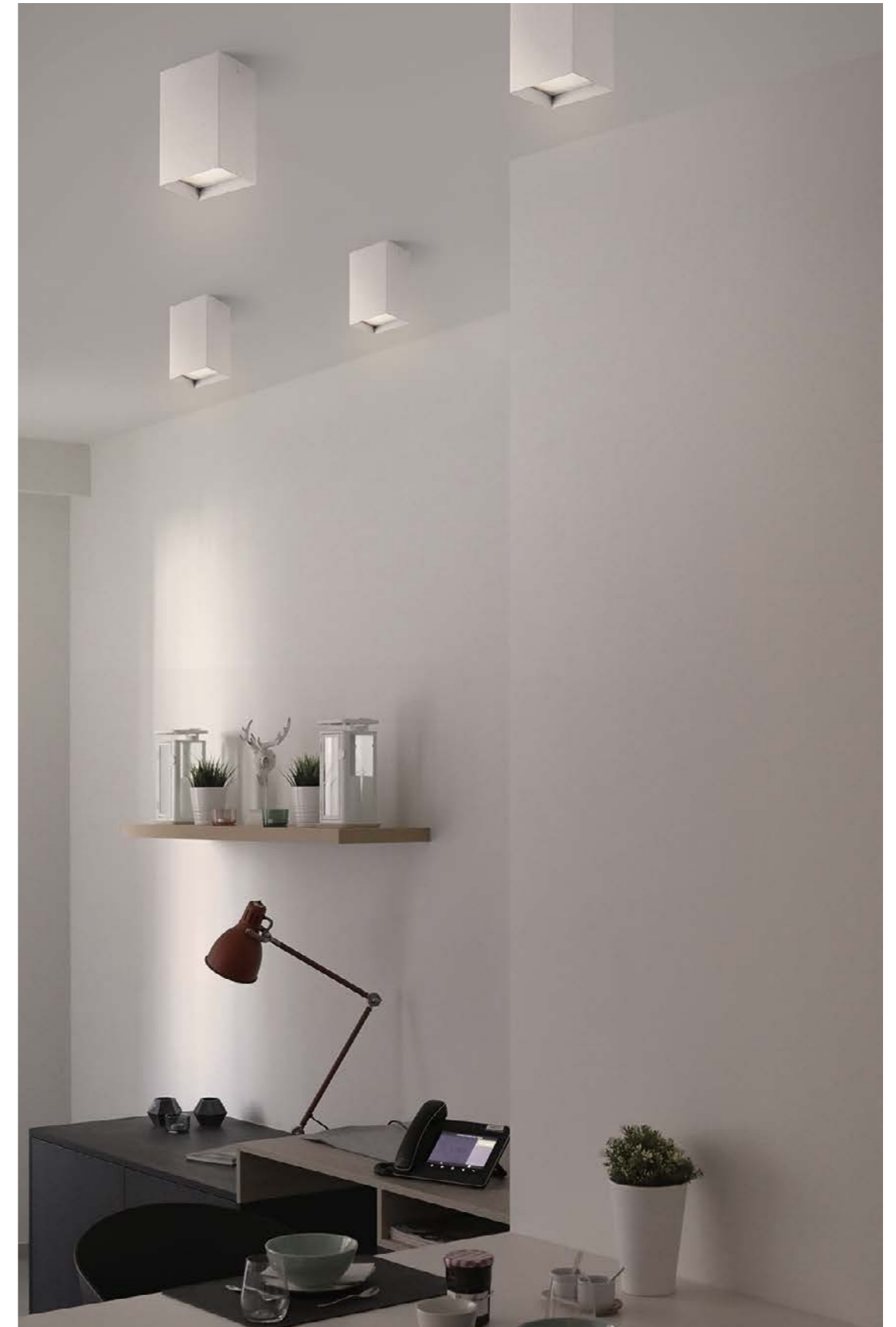
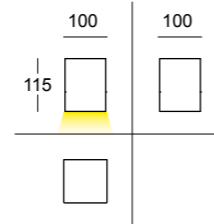

White

Sandy

Grey



White

Sandy

Grey



768/5 S

LED 1×4,5W 230V
 380lm - 3000°K upon request 2700°/4000°K
 Net weight 380gr - Gross weight 550gr
 Volume m³ 0,0047
 Dimmable PHASE-CUT DIMMING
 CE IP20

768/7 S

LED 1×8,7W 230V
 740lm 3000°K upon request 2700°/4000°K
 Net weight 460gr - Gross weight 630gr
 Volume m³ 0,0047
 Dimmable PHASE-CUT DIMMING
 CE IP20

768/9 S

LED 1×13W 230V
 1140lm 3000°K upon request 2700°/4000°K
 Net weight 730gr - Gross weight 1000gr
 Volume m³ 0,0090
 Dimmable PHASE-CUT DIMMING
 CE IP20

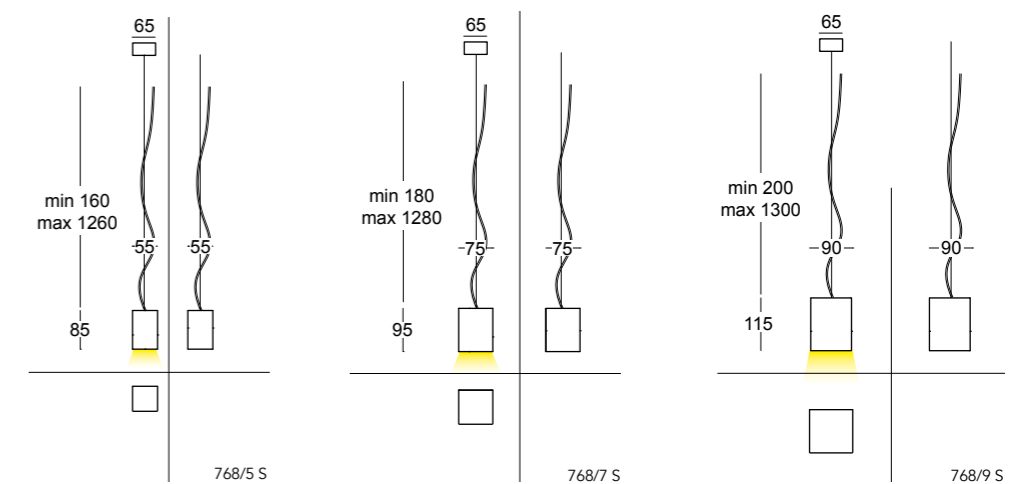

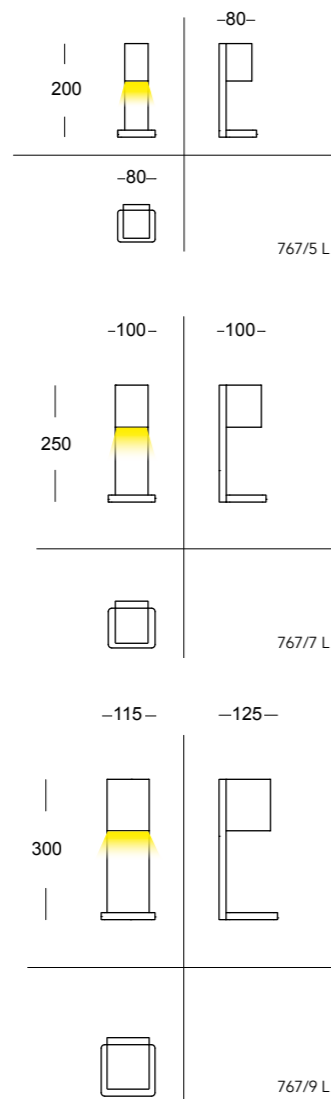

767/5 L

1x4,5W 230V
 380lm - 3000°K upon request 2700°/4000°K
 Net weight 500gr - Gross weight 680gr
 Volume m³ 0,0047
 CE Ⓢ IP20

767/7 L

1x8,7W 230V
 740lm - 3000°K upon request 2700°/4000°K
 Net weight 840gr - Gross weight 1180gr
 Volume m³ 0,0090
 CE Ⓢ IP20

767/9 L

1x13W 230V
 1140lm - 3000°K upon request 2700°/4000°K
 Net weight 1090gr - Gross weight 1600gr
 Volume m³ 0,018
 CE Ⓢ IP20



Cubick | Wall - Ceiling - Suspension - Table

Street Street System

design by C. Cattaneo

La serie Street e Street System rappresentano un'innovativa interpretazione dell'illuminazione, offrendo lampade dal design squadrato o rettangolare che integrano al loro interno lampadine a LED GX53. Ciò che le rende veramente uniche sono le incisioni artistiche nel metacrilato, che, una volta illuminate, creano un effetto scenografico mozzafiato, illuminando attraverso i caratteristici tagli della lampada.

Inoltre, la serie Street System offre un'ulteriore flessibilità grazie alla sua natura componibile. Da un unico punto luce, è possibile creare la propria composizione luminosa, combinando diversi elementi per realizzare configurazioni uniche e personalizzate. Questo permette di adattare l'illuminazione alle esigenze specifiche e alle preferenze estetiche, creando atmosfere suggestive che si integrano armoniosamente con l'ambiente circostante.

Entrambe le serie non solo forniscono un'illuminazione efficiente e di alta qualità, ma anche un'esperienza visiva e artistica che arricchisce l'ambiente. Grazie alla combinazione di tecnologia LED all'avanguardia, design creativo e possibilità di personalizzazione, le lampade della serie Street e Street System rappresentano la scelta ideale per coloro che cercano un'illuminazione che unisca funzionalità, estetica e flessibilità in modo innovativo.

The Street and Street System series represent an innovative interpretation of lighting, offering lamps with a square or rectangular design that incorporate GX53 LED bulbs inside. What makes them truly unique are the artistic engravings in the methacrylate, which, when illuminated, create a breathtaking scenic effect, lighting through the lamp's characteristic cuts.

In addition, the Street System series offers further flexibility thanks to its modular nature. From a single light point, you can create your own lighting composition, combining different elements to create unique and customised configurations. This allows you to adapt the lighting to your specific needs and aesthetic preferences, creating striking atmospheres that blend harmoniously with the surrounding environment.

Both series provide not only efficient and high-quality lighting, but also a visual and artistic experience that enriches the ambience. Combining state-of-the-art LED technology, creative design and customisation possibilities, the Street and Street System series lamps are the ideal choice for those seeking lighting that combines functionality, aesthetics and flexibility in an innovative way.

Die Serien Street und Street System stellen eine innovative Interpretation der Beleuchtung dar. Sie bieten Lampen mit quadratischem oder rechteckigem Design, die im Inneren mit GX53 LED-Lampen ausgestattet sind. Was sie wirklich einzigartig macht, sind die kunstvollen Gravuren im Methacrylat, die, wenn sie beleuchtet werden, einen atemberaubenden szenischen Effekt erzeugen, der durch die charakteristischen Schnitte der Lampe leuchtet.

Darüber hinaus bietet die Street System-Serie dank ihres modularen Charakters weitere Flexibilität. Von einem einzigen Lichtpunkt aus können Sie Ihre eigene Beleuchtungskomposition erstellen, indem Sie verschiedene Elemente zu einzigartigen und maßgeschneiderten Konfigurationen kombinieren. So können Sie die Beleuchtung an Ihre spezifischen Bedürfnisse und ästhetischen Vorlieben anpassen und eine eindrucksvolle Atmosphäre schaffen, die sich harmonisch in die Umgebung einfügt.

Beide Serien bieten nicht nur eine effiziente und hochwertige Beleuchtung, sondern auch ein visuelles und künstlerisches Erlebnis, das das Ambiente bereichert. Durch die Kombination von modernster LED-Technologie, kreativem Design und individuellen Anpassungsmöglichkeiten sind die Lampen der Serien Street und Street System die ideale Wahl für alle, die eine Beleuchtung suchen, die Funktionalität, Ästhetik und Flexibilität auf innovative Weise verbindet.





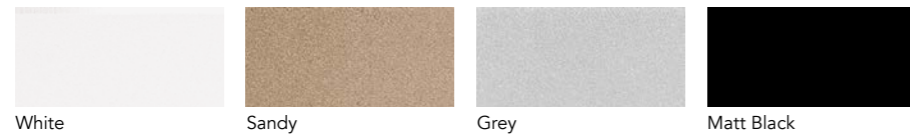

White

Sandy

Grey

Matt Black

Modulo Street System

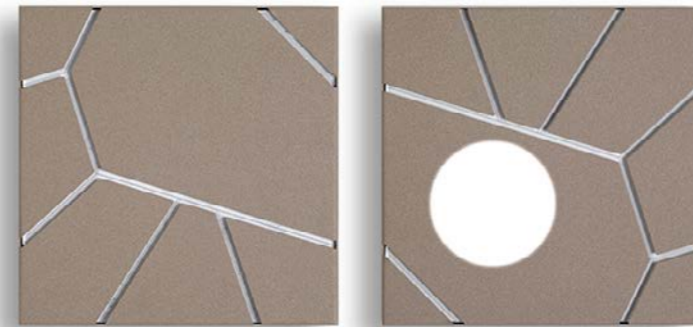

Veloce sistema di montaggio.

Unico punto luce per eseguire tutte le composizioni che si desidera.

Fast installation system.

A single light point that can let you creating all the combinations you like.

Schnelles Einbausystem.

Eine Leuchte mit die kann man alle Forme zusammensetzen.

874/20 C

220-240V - 1 Gx53 LED

Net weight 900gr

Gross weight 1210gr

Volume 0,011 m³

Lamp supplied without bulbs

CE IP20

873/20 PA

220-240V - 1 Gx53 LED

Net weight 900gr

Gross weight 1210gr

Volume 0,011 m³

Lamp supplied without bulbs

CE IP20

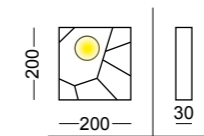
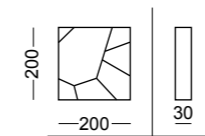



873/80 PA
 220-240V - 4 Gx53 LED
 Net weight 1900gr
 Gross weight 3500gr
 Volume 0,054 m3
 Lamp supplied without bulbs
 CE IP20

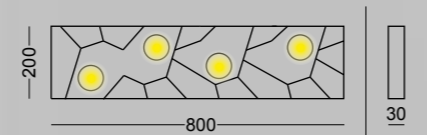

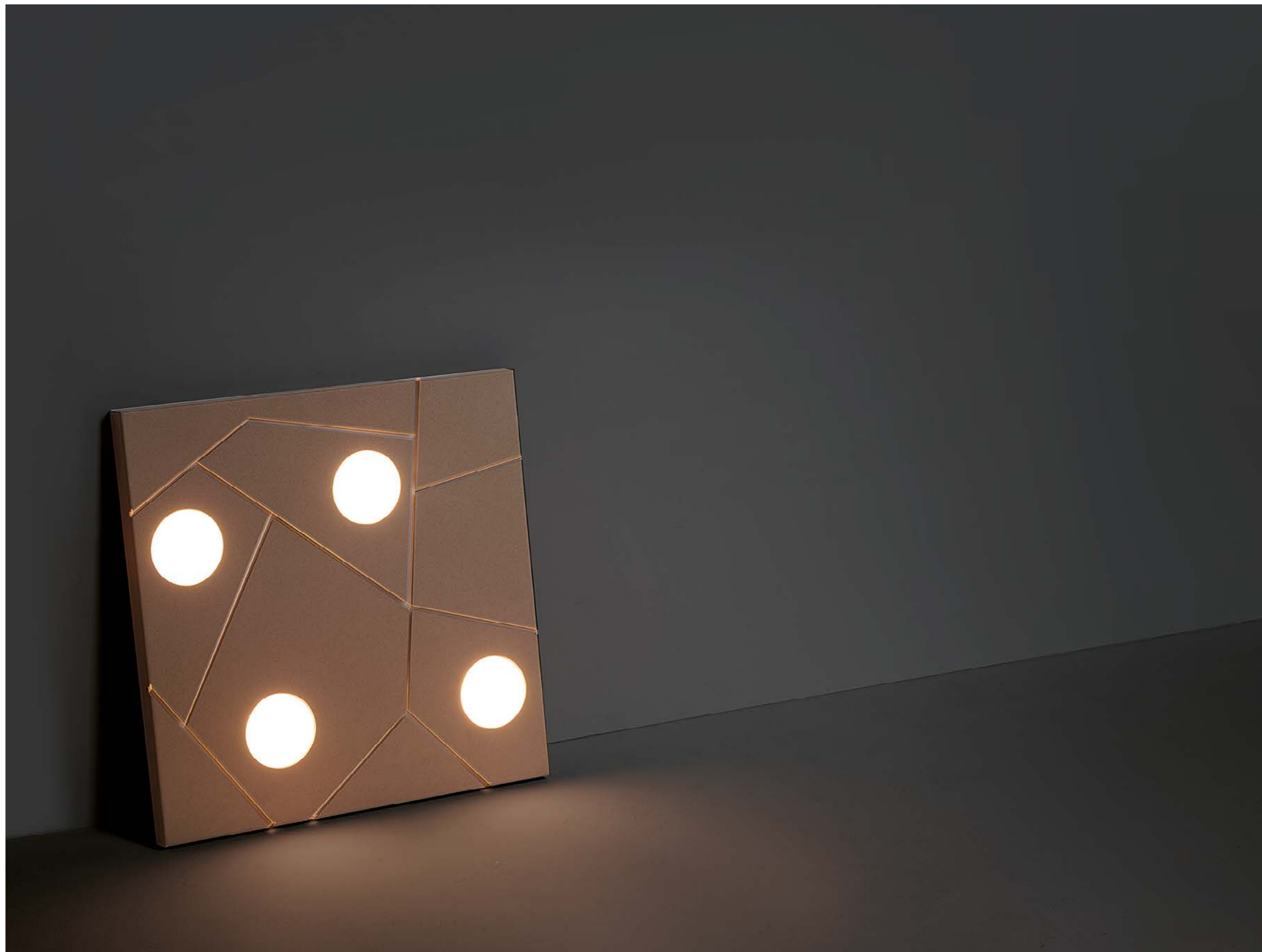

873/45 PA
220-240V - 4 Gx53 LED
Net weight 2550gr
Gross weight 3950gr
Volume 0,048 m3
Lamp supplied without bulbs
CE IP20

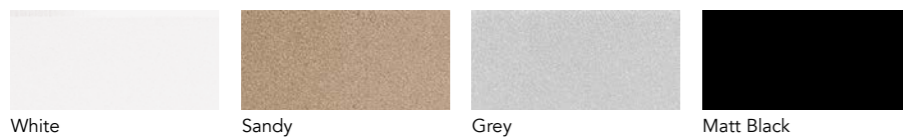

White

Sandy

Grey

Matt Black

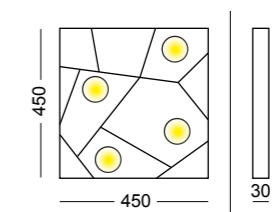

Street | Ceiling - Wall

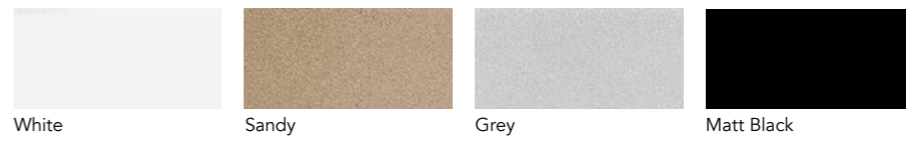

873/30 PA
220-240V - 2 Gx53 LED
Net weight 1240gr
Gross weight 1800gr
Volume 0,02 m3
Lamp supplied without bulbs
CE  IP20

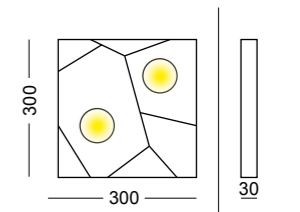

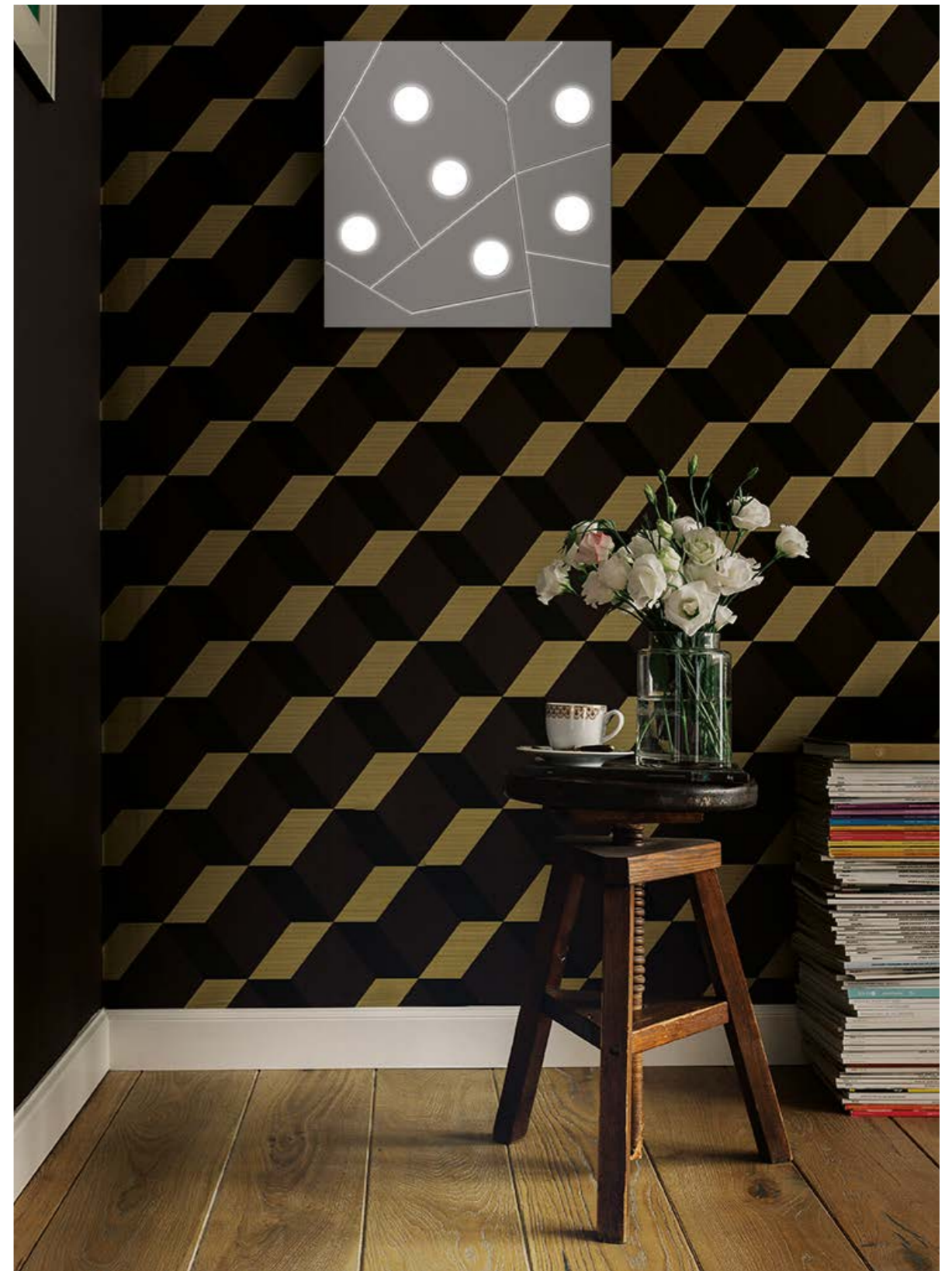

873/60 PA
 220-240V - 6 Gx53 LED
 Net weight 3000gr
 Gross weight 5000gr
 Volume 0,077 m³
 Lamp supplied without bulbs
 CE IP20

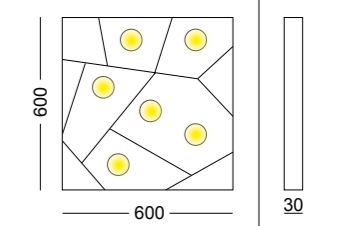

Fuorisquadra

design by C. Cattaneo

La lampada Fuorisquadra è un'esclusiva fusione di forma e funzionalità, disponibile in due varianti: sospensione e plafone. Il suo design distintivo si basa su una piastra dalle linee audaci e contemporanee, che cattura l'attenzione e aggiunge un tocco di modernità a qualsiasi ambiente.

La piastra della lampada Fuorisquadra presenta una forma particolare che si distingue per la sua originalità e raffinatezza. All'interno di questa struttura innovativa sono integrati efficacemente i moderni LED, garantendo una illuminazione efficiente e uniforme.

La versione sospensione della lampada Fuorisquadra aggiunge un elemento di eleganza sospesa nell'aria, mentre la versione plafone si fonde armoniosamente con il soffitto, creando un effetto di continuità con lo spazio circostante.

Con la lampada Fuorisquadra, non solo si ottiene una fonte luminosa affidabile e efficiente, ma anche un pezzo di design che arricchisce l'ambiente in cui è collocata, conferendo un tocco di stile contemporaneo e sofisticato.

Fuorisquadra is a unique fusion of form and function, available in two variants: pendant and surface mounted. Its distinctive design is based on a plate with bold, contemporary lines, which catches the eye and adds a modern touch to any ambience.

The Fuorisquadra lamp plate has a distinctive shape that stands out for its originality and sophistication. Modern LEDs are effectively integrated within this innovative structure, ensuring efficient and uniform illumination.

The pendant version of the Fuorisquadra lamp adds an element of elegance suspended in the air, while the ceiling version blends harmoniously with the ceiling, creating an effect of continuity with the surrounding space.

With the Fuorisquadra, you not only get a reliable and efficient light source, but also a design piece that enriches the room in which it is placed, giving it a contemporary and sophisticated touch of style.

Die Fuorisquadra-Leuchte ist eine einzigartige Verschmelzung von Form und Funktion und ist in zwei Varianten erhältlich: als Pendelleuchte und als Aufbauleuchte. Ihr unverwechselbares Design basiert auf einer Platte mit kühnen, zeitgenössischen Linien, die das Auge fesselt und jedem Ambiente einen modernen Touch verleiht.

Die Fuorisquadra-Lampenplatte hat eine unverwechselbare Form, die sich durch ihre Originalität und Raffinesse auszeichnet. In diese innovative Struktur sind moderne LEDs integriert, die eine effiziente und gleichmäßige Beleuchtung gewährleisten.

Die Pendelleuchte Fuorisquadra verleiht der Leuchte einen eleganten, schwebenden Charakter, während die Deckenleuchte sich harmonisch in die Decke einfügt und so eine Kontinuität mit dem umgebenden Raum schafft.

Mit der Fuorisquadra-Leuchte erhalten Sie nicht nur eine zuverlässige und effiziente Lichtquelle, sondern auch ein Designerstück, das den Raum, in dem sie platziert wird, bereichert und ihm einen modernen und raffinierten Stil verleiht.





White

Sandy

Grey

764/50 S

LED 230V
 3040 + 760lm 3000°K upon request 2700°/4000°K
 Net weight 4600gr - Gross weight 6700gr
 Volume m³ 0,047
 Dimmable PHASE-CUT DIMMING

CE IP20

764/64 S

LED 230V
 4560+1140lm 3000°K upon request 2700°/4000°K
 Net weight 8920gr - Gross weight 10010gr
 Volume m³ 0,077
 Dimmable PHASE-CUT DIMMING

CE IP20

764/100 S

LED 230V
 5700+1520lm 3000°K upon request 2700°/4000°K
 Net weight 11500gr - Gross weight 14200gr
 Volume m³ 0,133
 Dimmable PHASE-CUT DIMMING

CE IP20

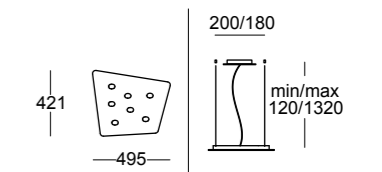

764/50 S

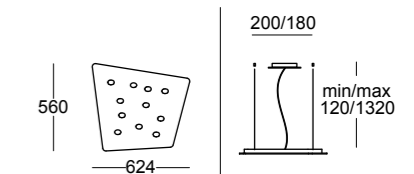

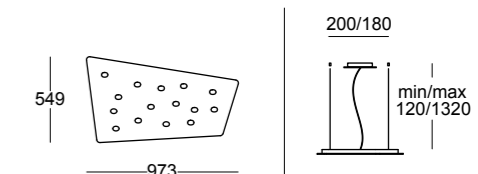

764/64 S



764/100 S



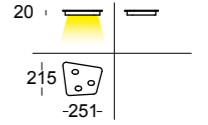

764/25 PA

LED 230V
 760lm - 3000°K upon request 2700°/4000°K
 Net weight 1010gr - Gross weight 1420gr
 Volume m³ 0,014
 PHASE-CUT DIMMING
 



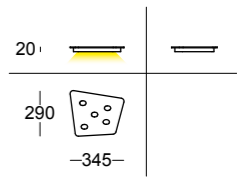

764/35 PA

LED 230V
 1900lm - 3000°K upon request 2700°/4000°K
 Net weight 1950gr - Gross weight 2760gr
 Volume m³ 0,020
 PHASE-CUT DIMMING
 



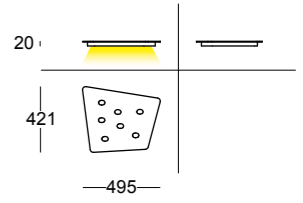

764/50 PA

LED 230V
 3040lm - 3000°K upon request 2700°/4000°K
 Net weight 4900gr - Gross weight 5700gr
 Volume m³ 0,047
 PHASE-CUT DIMMING
 



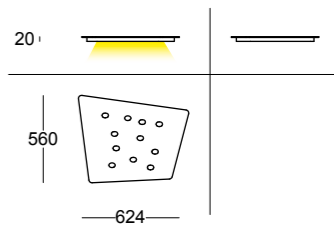

764/64 PA

LED 230V
 4560lm - 3000°K upon request 2700°/4000°K
 Net weight 8100gr - Gross weight 9300gr
 Volume m³ 0,077
 PHASE-CUT DIMMING
 



764/100 PA

LED 230V
 5700lm - 3000°K upon request 2700°/4000°K
 Net weight 10800gr - Gross weight 13400gr
 Volume m³ 0,14
 PHASE-CUT DIMMING
 

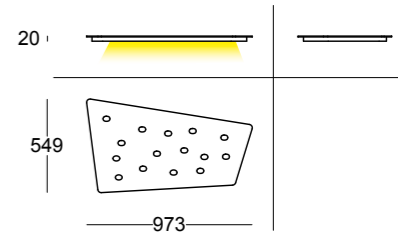

White

Sandy

Grey

Biscotto

design by C. Cattaneo

La lampada Biscotto è un'affascinante creazione disponibile in due versioni: sospensione e plafone. Caratterizzata da un design contemporaneo e minimalista, questa lampada si distingue per la sua eleganza senza tempo.

All'interno della sua struttura, troviamo una serie di punti luce a LED, disposti strategicamente per garantire un'illuminazione uniforme e piacevole. Questa caratteristica non solo rende la lampada Biscotto un elemento funzionale, ma anche un punto focale di stile per qualsiasi ambiente.

La versione sospensione della lampada Biscotto aggiunge un tocco di leggerezza e dinamismo, mentre la versione a plafone si integra armoniosamente con il soffitto, offrendo un'atmosfera luminosa e accogliente.

Con la sua estetica moderna e l'efficienza della tecnologia LED, la lampada Biscotto si presenta come un'eccellente scelta per coloro che cercano un'elevato livello di illuminazione senza rinunciare allo stile e all'eleganza.

Biscotto is a fascinating creation available in two versions: pendant and ceiling. Characterised by a contemporary and minimalist design, this lamp stands out for its timeless elegance.

Within its structure, we find a series of LED light points, strategically arranged to ensure uniform and pleasant illumination. This feature not only makes the Biscotto a functional element, but also a stylish focal point for any room.

The pendant version of the Biscotto adds a touch of lightness and dynamism, while the ceiling version blends harmoniously with the ceiling, providing a bright and welcoming atmosphere.

With its modern aesthetics and the efficiency of LED technology, the Biscotto is an excellent choice for those seeking a high level of illumination without sacrificing style and elegance.

Die Leuchte Biscotto ist eine faszinierende Kreation, die in zwei Versionen erhältlich ist: als Pendelleuchte und als Deckenleuchte. Gekennzeichnet durch ein modernes und minimalistisches Design, zeichnet sich diese Leuchte durch ihre zeitlose Eleganz aus.

In ihrer Struktur befindet sich eine Reihe von LED-Lichtpunkten, die strategisch angeordnet sind, um eine gleichmäßige und angenehme Beleuchtung zu gewährleisten. Diese Eigenschaft macht die Biscotto-Leuchte nicht nur zu einem funktionalen Element, sondern auch zu einem stilvollen Blickfang für jeden Raum.

Die Pendelleuchte Biscotto verleiht dem Raum einen Hauch von Leichtigkeit und Dynamik, während die Deckenleuchte sich harmonisch in die Decke einfügt und eine helle und freundliche Atmosphäre schafft.

Mit ihrer modernen Ästhetik und der Effizienz der LED-Technologie ist die Leuchte Biscotto eine ausgezeichnete Wahl für alle, die ein hohes Beleuchtungsniveau suchen, ohne auf Stil und Eleganz zu verzichten.







White

Sandy



Grey



765/100 S

LED 5+2x4,5W 230V
 1900+760lm - 3000°K upon request 2700°/4000°K
 Net weight 2650gr - Gross weight 3870gr
 Volume m³ 0,022
 PHASE-CUT DIMMING
 

765/130 S

LED 7+2x4,5W 230V
 2660+760lm - 3000°K upon request 2700°/4000°K
 Net weight 4200gr - Gross weight 5500gr
 Volume m³ 0,046
 PHASE-CUT DIMMING
 

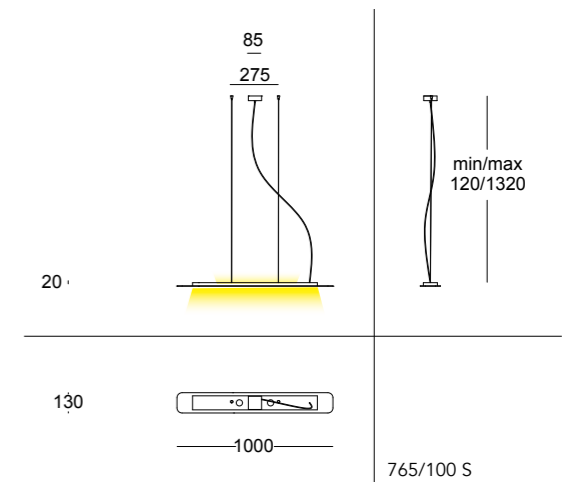

765/100 S

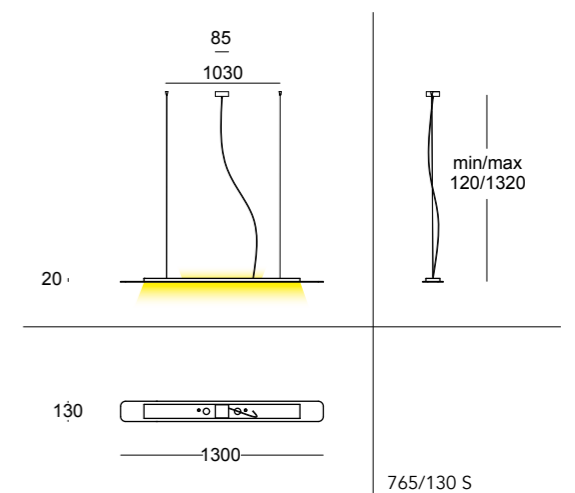

765/130 S



White

Sandy

Grey



765/60 PA

LED 4x4,5W 230V
 1520lm - 3000°K upon request 2700°/4000°K
 Net weight 1620gr - Gross weight 2340gr
 Volume m³ 0,013

 PHASE-CUT DIMMING

  IP20

765/100 PA

LED 5x4,5W 230V
 1900lm - 3000°K upon request 2700°/4000°K
 Net weight 2450gr - Gross weight 3780gr
 Volume m³ 0,022

 PHASE-CUT DIMMING

  IP20

765/130 PA

LED 7x4,5W 230V
 2660lm - 3000°K upon request 2700°/4000°K
 Net weight 4500gr - Gross weight 5200gr
 Volume m³ 0,046

 PHASE-CUT DIMMING

  IP20

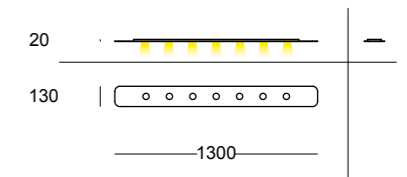
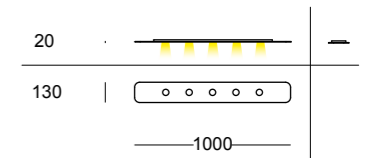
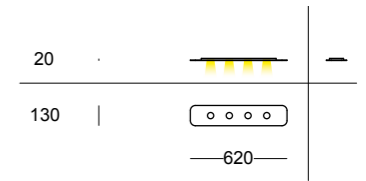

Plateau

design by C. Cattaneo

La lampada Plateau, disponibile sia in versione sospensione che plafone, rappresenta un'interpretazione unica e moderna dell'illuminazione. Il suo design distintivo si basa su una lastra sottile e quadrata di metallo, che conferisce un'aria di eleganza e minimalismo all'ambiente.

Allungati all'interno di questa struttura minimalista, troviamo dei punti luce quadrati a LED, distribuiti in modo armonioso per garantire un'illuminazione uniforme e coinvolgente. Questo sofisticato sistema luminoso aggiunge un tocco di contemporaneità alla lampada Plateau, rendendola un vero e proprio oggetto d'arte illuminato.

La versione sospensione della lampada Plateau offre un effetto visivo sospeso, creando un'atmosfera avvolgente e accogliente, mentre quella a plafone si fonde con il soffitto in modo elegante e discreto, contribuendo a definire lo spazio con stile e raffinatezza.

Con la sua combinazione di linee pulite, materiali di qualità e tecnologia LED all'avanguardia, la lampada Plateau si distingue come una scelta ideale per chi cerca un'illuminazione d'atmosfera dal design contemporaneo e sofisticato.

The Plateau, available in both pendant and ceiling versions, represents a unique and modern interpretation of lighting. Its distinctive design is based on a thin, square sheet of metal, which lends an air of elegance and minimalism to the ambience.

Housed within this minimalist structure, we find square LED light points, harmoniously distributed to provide even and engaging illumination. This sophisticated lighting system adds a contemporary touch to the Plateau lamp, making it a true illuminated art object.

The pendant version of the Plateau offers a suspended visual effect, creating an enveloping and welcoming atmosphere, while the surface-mounted version blends elegantly and discreetly into the ceiling, helping to define the space with style and sophistication.

With its combination of clean lines, quality materials and state-of-the-art LED technology, the Plateau lamp stands out as an ideal choice for those seeking atmospheric lighting with a contemporary and sophisticated design.

Die Plateau-Leuchte, die sowohl als Pendel- als auch als Deckenleuchte erhältlich ist, stellt eine einzigartige und moderne Interpretation der Beleuchtung dar. Ihr unverwechselbares Design basiert auf einer dünnen, quadratischen Metallplatte, die dem Ambiente einen Hauch von Eleganz und Minimalismus verleiht.

In dieser minimalistischen Struktur befinden sich quadratische LED-Lichtpunkte, die harmonisch verteilt sind und für eine gleichmäßige und ansprechende Beleuchtung sorgen. Dieses ausgeklügelte Beleuchtungssystem verleiht der Leuchte Plateau einen modernen Touch und macht sie zu einem echten beleuchteten Kunstobjekt.

Die Pendelleuchte Plateau bietet einen schwebenden visuellen Effekt, der eine einladende Atmosphäre schafft, während sich die Anbauleuchte elegant und diskret in die Decke einfügt und dazu beiträgt, den Raum mit Stil und Raffinesse zu definieren.

Mit ihrer Kombination aus klaren Linien, hochwertigen Materialien und modernster LED-Technologie ist die Leuchte Plateau die ideale Wahl für alle, die eine stimmungsvolle Beleuchtung mit modernem und anspruchsvollem Design suchen.

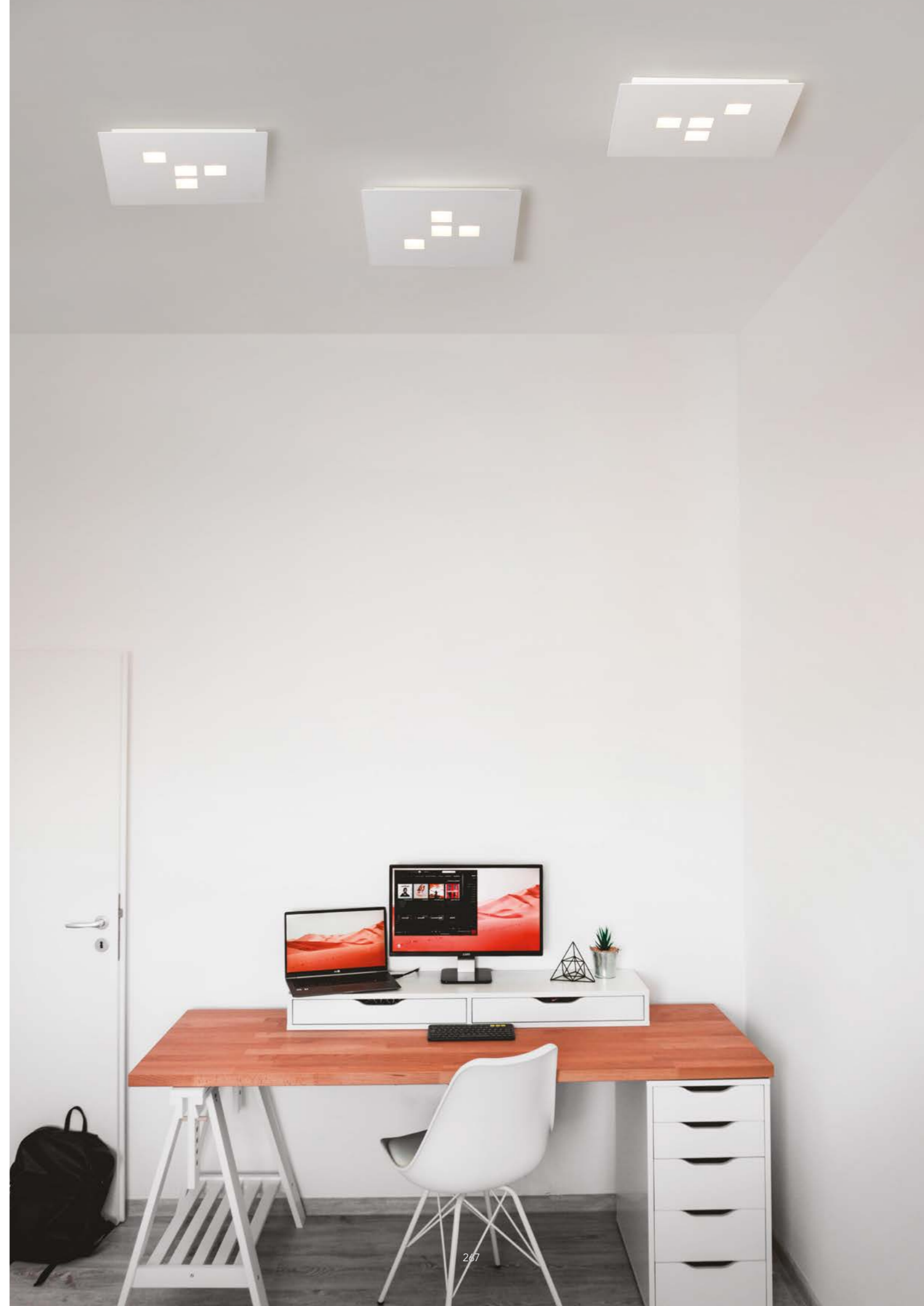



White

Sandy

Grey



773/52 S

LED 9x4,5W 230V
 3420lm 3000°K upon request 2700°/4000°K
 Net weight 6950gr - Gross weight 8000gr
 Volume m³ 0,047

 PHASE-CUT DIMMING

CE  IP20

773/60 S

LED 13x4,5W 230V
 4940lm 3000°K upon request 2700°/4000°K
 Net weight 7980gr - Gross weight 9100gr
 Volume m³ 0,077

 PHASE-CUT DIMMING

CE  IP20

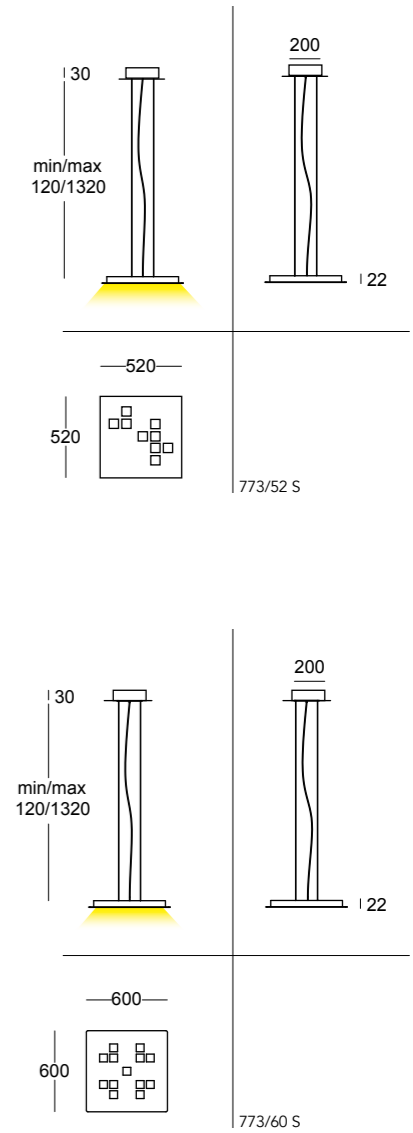

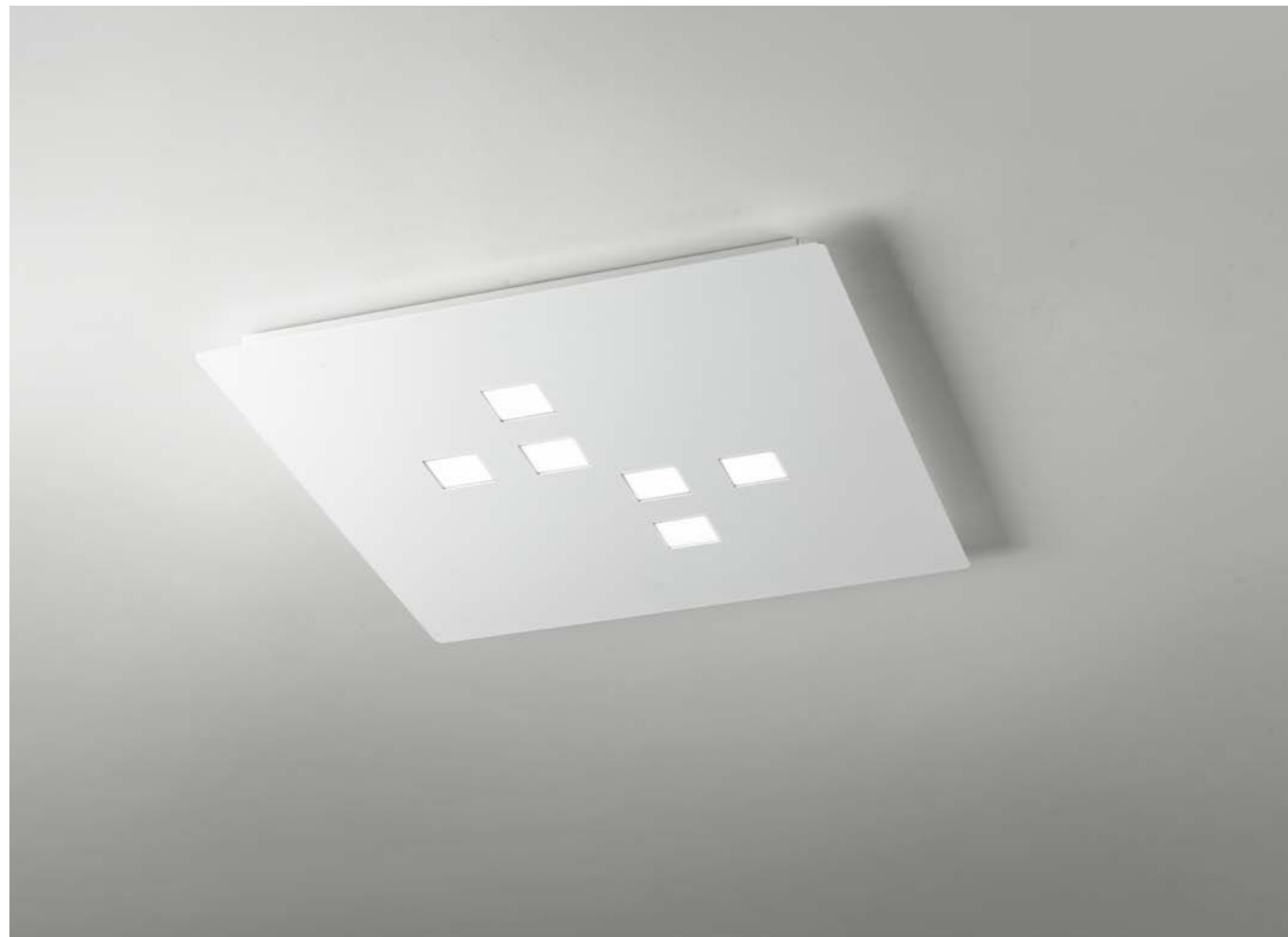

White

Sandy

Grey

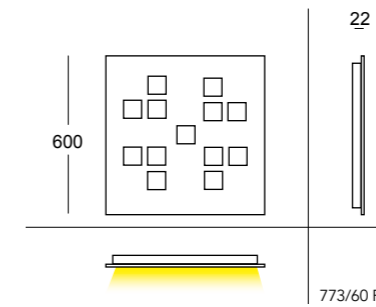
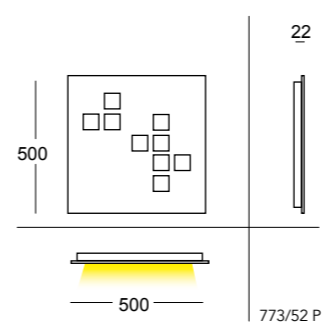
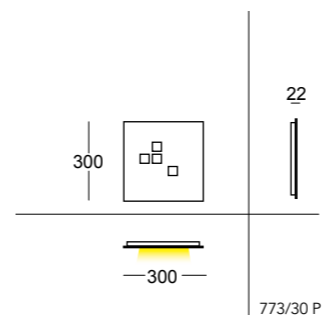
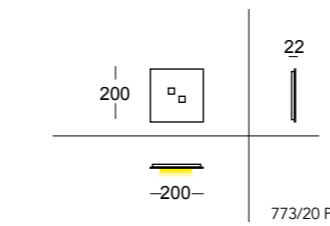

773/20 P

LED 2x4,5W 230V
 760lm 3000°K upon request 2700°/4000°K
 Net weight 950gr - Gross weight 1500gr
 Volume m³ 0,014
 PHASE-CUT DIMMING
 CE IP20

773/30 P

LED 4x4,5W 230V
 1520lm 3000°K upon request 2700°/4000°K
 Net weight 1650gr - Gross weight 2800gr
 Volume m³ 0,020
 PHASE-CUT DIMMING
 CE IP20

773/40 P

LED 6x4,5W 230V
 2280lm 3000°K upon request 2700°/4000°K
 Net weight 3800gr - Gross weight 5200gr
 Volume m³ 0,029
 PHASE-CUT DIMMING
 CE IP20

773/52 P

LED 9x4,5W 230V
 3420lm 3000°K upon request 2700°/4000°K
 Net weight 6200gr - Gross weight 7700gr
 Volume m³ 0,047
 PHASE-CUT DIMMING
 CE IP20

773/60 P

LED 13x4,5W 230V
 4940lm 3000°K upon request 2700°/4000°K
 Net weight 7600gr - Gross weight 10100gr
 Volume m³ 0,077
 PHASE-CUT DIMMING
 CE IP20

Tratto

design by C. Cattaneo

La serie Tratto presenta lampade eleganti e versatili, disponibili in varianti a sospensione, parete e plafone. Realizzate in metallo di alta qualità e caratterizzate da una struttura interna in policarbonato, queste lampade offrono non solo una luce diretta e indiretta impeccabile, ma anche un'illuminazione diffusa che rende l'ambiente circostante luminoso e accogliente. Ideali per creare un'atmosfera calda e invitante in qualsiasi spazio

The Tratto series presents elegant and versatile lamps, available in pendant, wall and ceiling variants. Made of high-quality metal and featuring a polycarbonate inner structure, these lamps offer not only impeccable direct and indirect light, but also diffuse illumination that makes your surroundings bright and welcoming. Ideal for creating a warm and inviting atmosphere in any space

Die Serie Tratto präsentiert elegante und vielseitige Lampen, die als Pendel-, Wand- und Deckenleuchten erhältlich sind. Aus hochwertigem Metall gefertigt und mit einer Innenstruktur aus Polykarbonat ausgestattet, bieten diese Lampen nicht nur ein tadelloses direktes und indirektes Licht, sondern auch eine diffuse Beleuchtung, die Ihre Umgebung hell und einladend macht. Ideal für die Schaffung einer warmen und einladenden Atmosphäre in jedem Raum





White

Sandy

Grey



754/90 S

3x15W 24V Dc 220-240 V

6000lm 3000°K upon request 2700°/4000°K

Net weight 2650gr - Gross weight 4200gr

Volume m³ 0,022

 with leading edge or trailing edge dimmer

CE  IP20

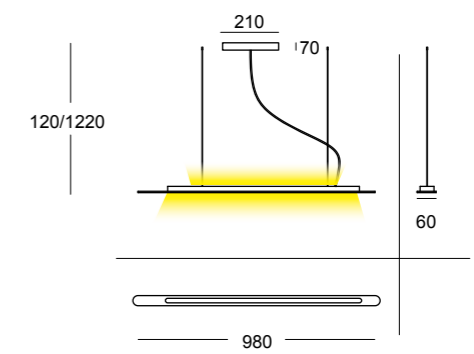

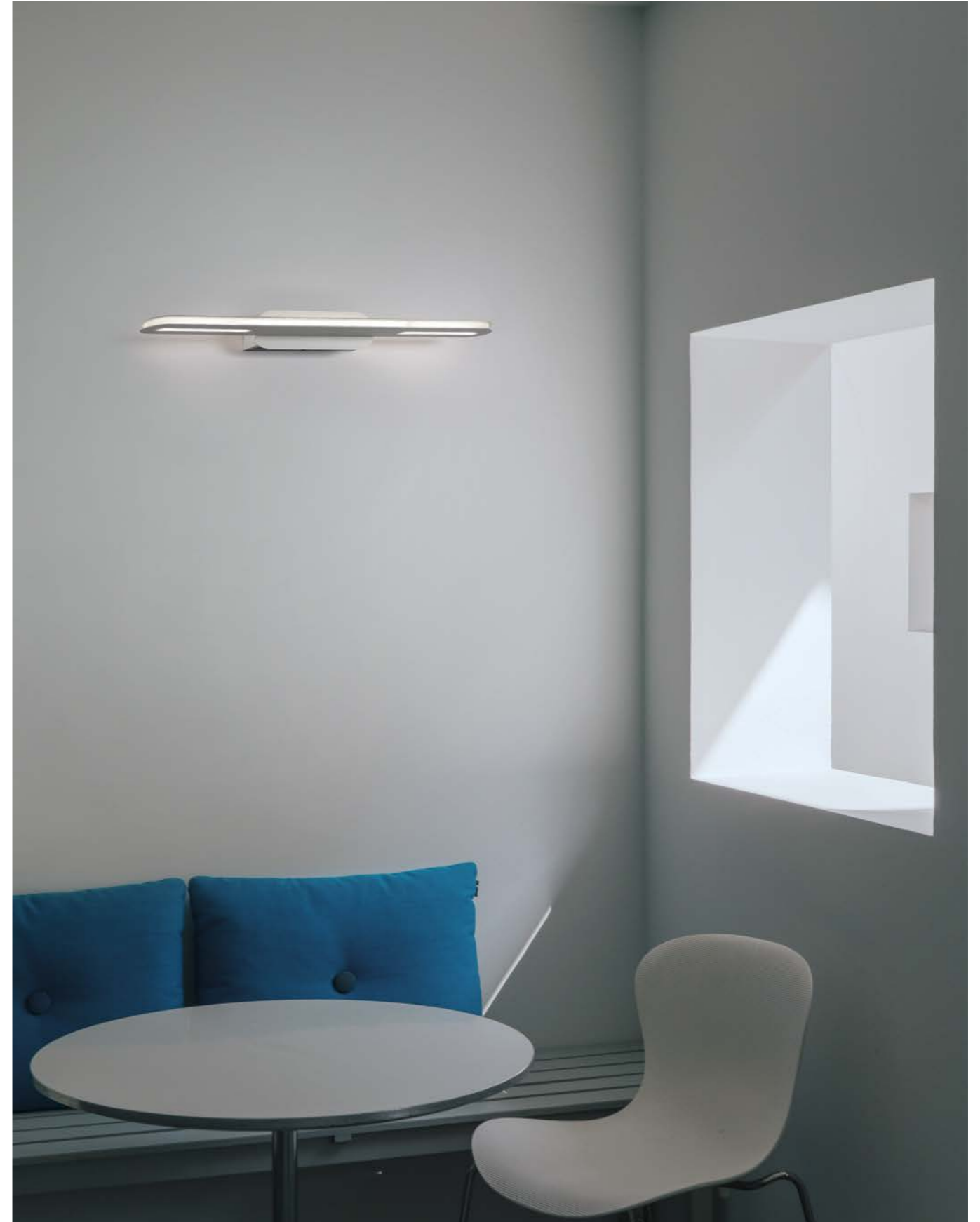



White

Sandy

Grey

754/60A | 754/60A IP* | Bi-emissione

LED 2x15W 24V Dc 220-240 V

4000lm - 3000°K upon request 2700°/4000°K

*High Protection IP44

Net weight 2150gr - Gross weight 2550gr

Volume m³ 0,013

CE IP20

754/90A | 754/90A IP* | Bi-emissione

LED 3x15W 24V Dc 220-240 V

6000lm 3000°K upon request 2700°/4000°K

*High Protection IP44

Net weight 2720gr - Gross weight 3490gr

Volume m³ 0,022

CE IP20

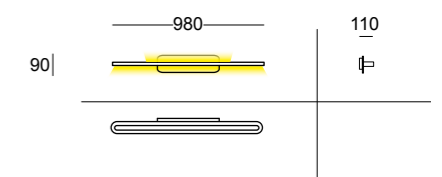
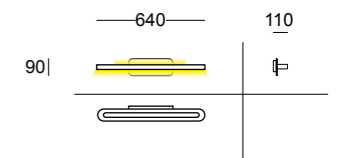



754/30A | 754/30A IP* | Mono-emissione
 LED 1x15W 220 24V Dc 220-240 V
 2000 lm - 3000°K upon request 2700°/4000°K
 *High Protection IP44
 Net weight 960gr - Gross weight 1330gr
 Volume m³ 0,013
 CE IP20

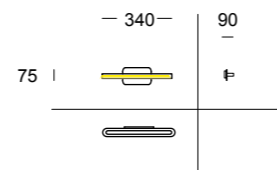

774/60A | 774/60A IP* | Mono-emissione
 LED 2x15W 24V Dc 220-240 V
 4000lm - 3000°K upon request 2700°/4000°K
 *High Protection IP44
 Net weight 2150gr - Gross weight 2550gr
 Volume m³ 0,013
 CE IP20

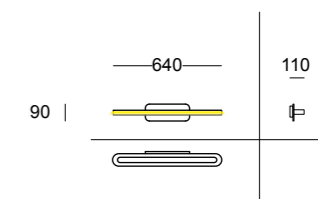

774/90A | 774/90A IP* | Mono-emissione
 LED 3x15W 24V Dc 220-240 V
 6000lm - 3000°K upon request 2700°/4000°K
 *High Protection IP44
 Net weight 2720gr - Gross weight 3490gr
 Volume m³ 0,022
 CE IP20

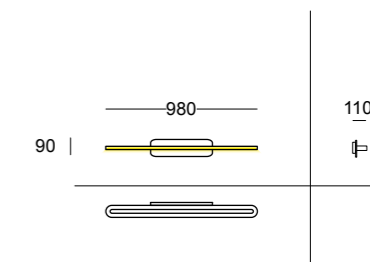



White

Sandy

Grey



754/30 PA | 754/30 PA IP*
 LED 1x15W 24V Dc 220 - 240V
 2000lm - 3000°K upon request 2700°/4000°K
 *High Protection IP44
 Net weight 900gr - Gross weight 1200gr
 Volume m³ 0,013
 CE IP20

754/60 PA | 754/60 PA IP*
 LED 2x15W 24V Dc 220 - 240V
 4000 lm - 3000°K upon request 2700°/4000°K
 *High Protection IP44
 Net weight 2050gr - Gross weight 2550gr
 Volume m³ 0,013
 CE IP20

754/90 PA | 754/90 PA IP*
 LED 3x15W 24V Dc 220 - 240V
 6000 lm - 3000°K upon request 2700°/4000°K
 *High Protection IP44
 Net weight 3080gr - Gross weight 3570gr
 Volume m³ 0,022
 CE IP20

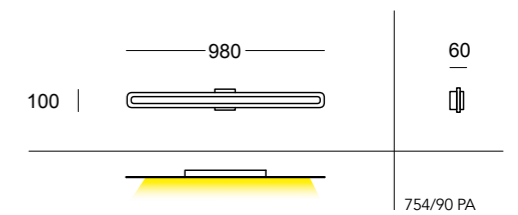
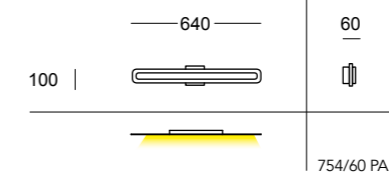
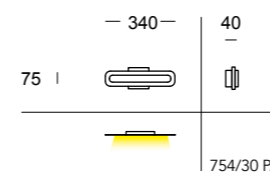

Bolle

design by C. Cattaneo

Bolle è una lampada incantata che trasforma ogni ambiente in un luogo magico. Composta da cerchi di metallo di diverse dimensioni, i cui bordi rivelano un interno in metacrilato, questa lampada a sospensione o plafoniera cattura l'immaginazione con la sua bellezza eterea. Disponibile in due dimensioni, si adatta perfettamente a una vasta gamma di spazi e stili.

Le Bolle diffondono luce con eleganza e stile, creando un'atmosfera eterea e suggestiva. Grazie alla combinazione di materiali di alta qualità e design accattivante, diventa un punto focale in qualsiasi stanza.

La sua versatilità consente di usarla come sospensione per aggiungere un tocco di raffinatezza sopra un tavolo o come plafoniera per distribuire uniformemente la luce nell'ambiente. Indipendentemente dall'uso, le Bolle trasformano ogni spazio in un'esperienza luminosa unica e affascinante.

Con Bolle, la luce diventa un'arte che danza delicatamente nell'aria, aggiungendo un tocco di magia e raffinatezza a ogni ambiente.

Bolle is an enchanted lamp that transforms any room into a magical place. Composed of metal circles of different sizes, the edges of which reveal a methacrylate interior, this pendant or ceiling lamp captures the imagination with its ethereal beauty. Available in two sizes, it fits perfectly in a wide range of spaces and styles.

The Bubbles diffuse light with elegance and style, creating an ethereal and evocative atmosphere. With its combination of high-quality materials and attractive design, it becomes a focal point in any room.

Its versatility allows it to be used as a pendant lamp to add a touch of sophistication above a table or as a ceiling light to distribute light evenly throughout the room. Regardless of use, Bolle transforms any space into a unique and fascinating lighting experience.

With Bolle, light becomes an art that dances delicately in the air, adding a touch of magic and sophistication to any ambience.

Bolle ist eine verzauberte Lampe, die jeden Raum in einen magischen Ort verwandelt. Diese Pendel- oder Deckenleuchte besteht aus Metallkreisen in verschiedenen Größen, deren Ränder das Innere aus Methacrylat offenbaren, und bezaubert durch ihre ätherische Schönheit. Erhältlich in zwei Größen, passt sie perfekt in eine Vielzahl von Räumen und Stilen.

Die Bubbles verbreiten das Licht mit Eleganz und Stil und schaffen eine ätherische und stimmungsvolle Atmosphäre. Mit ihrer Kombination aus hochwertigen Materialien und attraktivem Design wird sie zu einem Blickfang in jedem Raum.

Dank ihrer Vielseitigkeit kann sie als Hängeleuchte über einem Tisch oder als Deckenleuchte zur gleichmäßigen Verteilung des Lichts im Raum verwendet werden. Unabhängig von ihrer Verwendung verwandelt Bolle jeden Raum in ein einzigartiges und faszinierendes Lichterlebnis.

Mit Bolle wird das Licht zu einer Kunst, die zart in der Luft tanzt und jedem Ambiente einen Hauch von Magie und Raffinesse hinzufügt.





White

Sandy

Grey



755/30 S

LED 1x17W 230V
 1500lm - 3000°K upon request 2700°/4000°K
 Net weight 1905gr - Gross weight 3505gr
 Volume m³ 0,031

 PHASE-CUT DIMMING

 

755/60 S

LED 3x17W 230V
 4500lm - 3000°K upon request 2700°/4000°K
 Net weight 7700gr - Gross weight 10800gr
 Volume m³ 0,078

 PHASE-CUT DIMMING

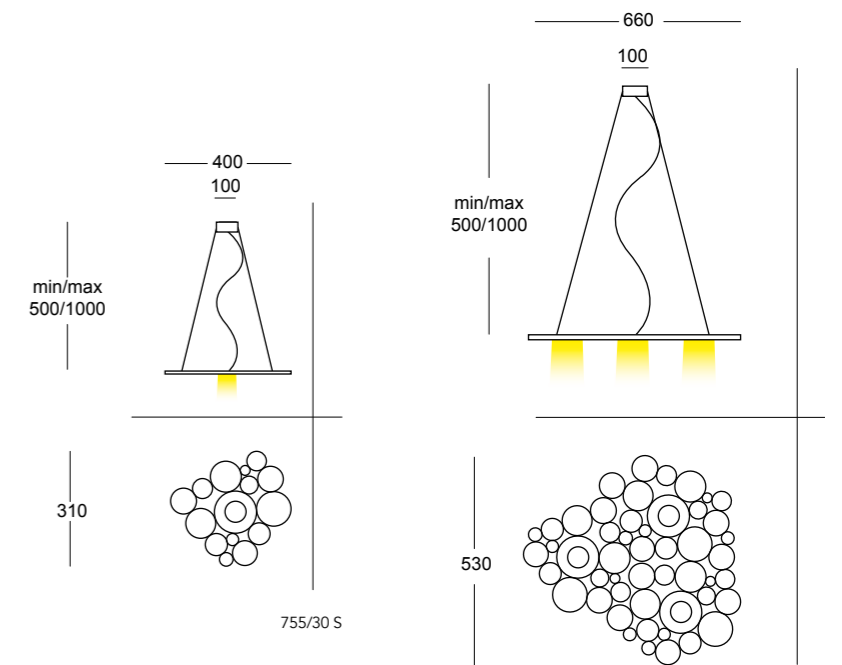

755/30 S

755/60 S



White

Sandy

Grey



755/30 PA

LED 1x17W 230V
 1500lm - 3000°K upon request 2700°/4000°K
 Net weight 1905gr - Gross weight 3505gr
 Volume m³ 0,031

PHASE-CUT DIMMING

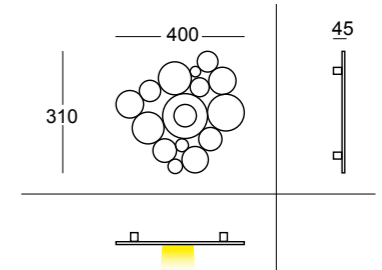

755/60 PA

LED 3x17W 230V
 4500lm - 3000°K upon request 2700°/4000°K
 Net weight 7700gr - Gross weight 10800gr
 Volume m³ 0,078

PHASE-CUT DIMMING

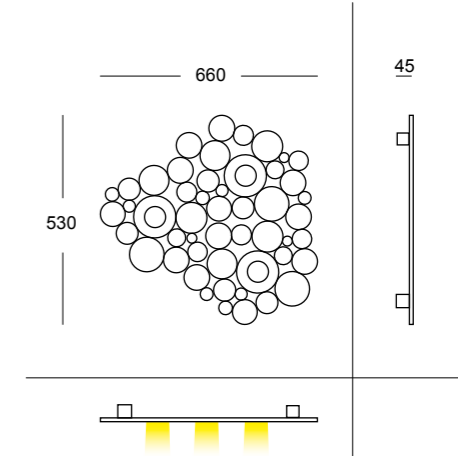

Adjustable

design by E. Giudici

La lampada da parete Adjustable è un'innovativa creazione che unisce funzionalità e design in modo sorprendente. Al centro della sua versatilità si trova una pallina da golf, che funge da fulcro per i movimenti regolabili della lampada.

Grazie a questa soluzione originale, la lampada Adjustable può essere facilmente regolata sia in altezza che in orizzontale, offrendo un'illuminazione personalizzata e adattabile alle esigenze specifiche dell'ambiente e dell'utilizzatore. La pallina da golf agisce come un meccanismo intuitivo e pratico, consentendo di modificare l'orientamento della luce con semplicità ed eleganza.

Questo elemento distintivo non solo conferisce alla lampada Adjustable un aspetto unico e intrigante, ma ne migliora anche la funzionalità, consentendo di dirigere la luce esattamente dove serve con precisione e facilità. Inoltre, la lampada Adjustable è estensibile, consentendo di adattare la sua lunghezza secondo necessità.

Con il suo design accattivante, la sua innovativa soluzione di regolazione e la sua estensibilità, la lampada da parete Adjustable è una scelta ideale per chi cerca un'illuminazione versatile e di alta qualità, capace di adattarsi alle mutevoli esigenze dell'ambiente circostante.

Adjustable wall lamp is an innovative creation that combines functionality and design in a surprising way. At the centre of its versatility is a golf ball, which serves as the fulcrum for the lamp's adjustable movements.

Thanks to this original solution, Adjustable can be easily adjusted both horizontally and vertically, offering customised lighting that can be adapted to the specific needs of the environment and the user. The golf ball acts as an intuitive and practical mechanism, allowing the orientation of the light to be changed simply and elegantly.

This distinctive element not only gives Adjustable a unique and intriguing appearance, but also enhances its functionality, allowing light to be directed exactly where it is needed with precision and ease. Furthermore, Adjustable is extendable, allowing its length to be adjusted as required.

With its attractive design, innovative adjustability and extendability, Adjustable wall lamp is an ideal choice for anyone looking for versatile, high-quality lighting that can adapt to the changing needs of its surroundings.

Die Adjustable Wandleuchte ist eine innovative Kreation, die Funktionalität und Design auf überraschende Weise verbindet. Im Mittelpunkt ihrer Vielseitigkeit steht ein Golfball, der als Drehpunkt für die verstellbaren Bewegungen der Leuchte dient.

Dank dieser originellen Lösung lässt sich die Adjustable-Leuchte sowohl horizontal als auch vertikal leicht verstellen und bietet so eine individuelle Beleuchtung, die sich an die spezifischen Bedürfnisse der Umgebung und des Benutzers anpassen lässt. Der Golfball dient als intuitiver und praktischer Mechanismus, mit dem sich die Ausrichtung der Leuchte einfach und elegant ändern lässt.

Dieses markante Element verleiht der Adjustable-Lampe nicht nur ein einzigartiges und faszinierendes Aussehen, sondern erhöht auch ihre Funktionalität, da das Licht genau dorthin gelenkt werden kann, wo es benötigt wird, und zwar präzise und einfach. Darüber hinaus ist die Adjustable-Leuchte ausziehbar, so dass ihre Länge je nach Bedarf angepasst werden kann.

Mit ihrem attraktiven Design, der innovativen Verstellbarkeit und der Ausziehbarkeit ist die Adjustable Wandleuchte die ideale Wahl für alle, die eine vielseitige, hochwertige Beleuchtung suchen, die sich den wechselnden Bedürfnissen ihrer Umgebung anpassen kann.





Adjustable | Wall



137/150 A
 220-240V - E27 LED
 Net weight 1556gr - Gross weight 3306gr
 Volume m³ 0,090
 2 boxes
 CE IP20

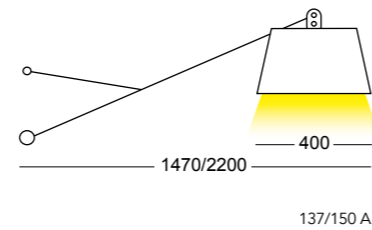

Adjustable | Wall

Diffuser colours



Nuvola

design by C. Cattaneo

La serie di lampade Nuvola incarna l'essenza della grazia e dell'incanto, offrendo un tocco di poesia luminosa all'ambiente circostante. Queste lampade, disponibili in due diverse dimensioni, sono realizzate con maestria utilizzando il vetro soffiato, che conferisce loro una delicatezza e una bellezza senza tempo.

La forma evocativa di nuvola dona un senso di leggerezza e serenità, trasformando lo spazio in cui sono collocate in un ambiente di calma e tranquillità. La serie Nuvola offre una varietà di opzioni per adattarsi alle diverse esigenze di illuminazione: dalla sospensione al plafone, dalla lampada da parete alla lampada da tavolo, ogni versione si adatta perfettamente alla sua funzione specifica, garantendo un'illuminazione avvolgente e suggestiva.

Grazie alla loro eleganza senza tempo e alla qualità artigianale dei materiali utilizzati, le lampade della serie Nuvola aggiungono un tocco di magia e raffinatezza a qualsiasi ambiente, trasformando lo spazio in un luogo di bellezza e contemplazione.

The Nuvola series embodies the essence of grace and enchantment, offering a touch of luminous poetry to the surroundings. These lamps, available in two different sizes, are skillfully crafted using blown glass, which gives them a timeless delicacy and beauty.

The evocative cloud shape gives a sense of lightness and serenity, transforming the space in which they are placed into an ambiente of calm and tranquillity. The Nuvola series offers a variety of options to suit different lighting needs: from pendant to surface-mounted, from wall lamp to table lamp, each version is perfectly suited to its specific function, providing enveloping and evocative lighting.

Thanks to their timeless elegance and the quality craftsmanship of the materials used, Nuvola lamps add a touch of magic and refinement to any environment, transforming the space into a place of beauty and contemplation.

Die Nuvola-Lampenserie verkörpert das Wesen der Anmut und des Zaubers und verleiht der Umgebung einen Hauch von leuchtender Poesie. Die in zwei verschiedenen Größen erhältlichen Lampen sind aus mundgeblasenem Glas gefertigt, was ihnen eine zeitlose Zartheit und Schönheit verleiht.

Die stimmungsvolle Wolkenform vermittelt ein Gefühl von Leichtigkeit und Heiterkeit und verwandelt den Raum, in dem sie aufgestellt werden, in ein Ambiente der Ruhe und Gelassenheit. Die Nuvola-Serie bietet eine Vielzahl von Optionen für unterschiedliche Beleuchtungsbedürfnisse: von der Pendel- bis zur Aufsatzleuchte, von der Wand- bis zur Tischleuchte, jede Version ist perfekt auf ihre spezifische Funktion abgestimmt und sorgt für eine umhüllende und stimmungsvolle Beleuchtung.

Dank ihrer zeitlosen Eleganz und der hochwertigen Verarbeitung der verwendeten Materialien verleihen die Leuchten der Serie Nuvola jeder Umgebung einen Hauch von Magie und Raffinesse und verwandeln den Raum in einen Ort der Schönheit und Kontemplation.



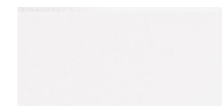

White

630/30 S

220-240V - E14 LED

Net weight 1450gr - Gross weight 2050gr

Volume m³ 0,020

CE IP20

630/50 S

220-240V - E27 LED

Net weight 3900gr - Gross weight 5500gr

Volume m³ 0,064

CE IP20

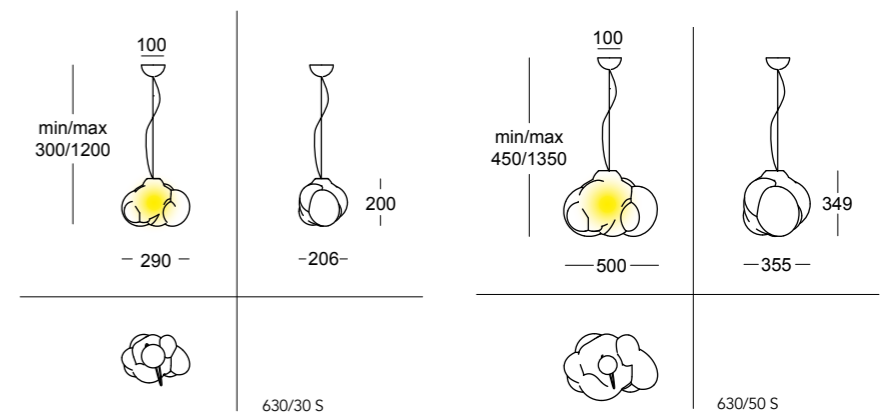

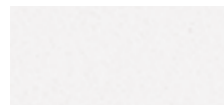

White



630/30 PA

220-240V - E14 LED

Net weight 1450gr - Gross weight 2050gr

Volume m³ 0,020

CE IP20

630/50 PA

220-240V - E27 LED

Net weight 3900gr - Gross weight 5500gr

Volume m³ 0,064

CE IP20

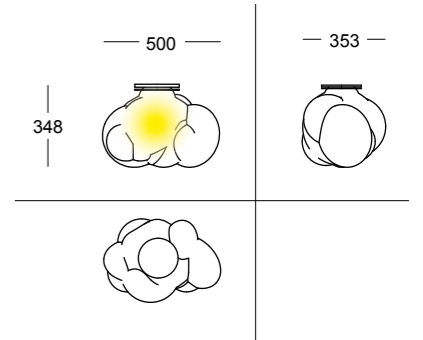
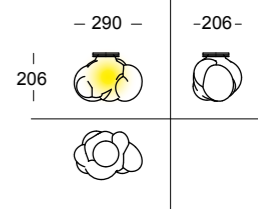



630/30 PA

220-240V - E14 LED

Net weight 1450gr - Gross weight 2050gr

Volume m³ 0,020

CE  IP20

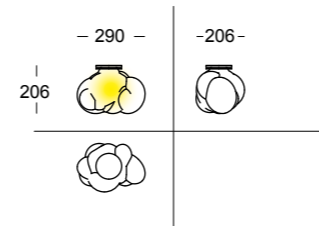

630/50 PA

220-240V - E27 LED

Net weight 3900gr - Gross weight 5500gr

Volume m³ 0,064

CE  IP20

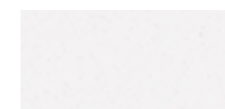
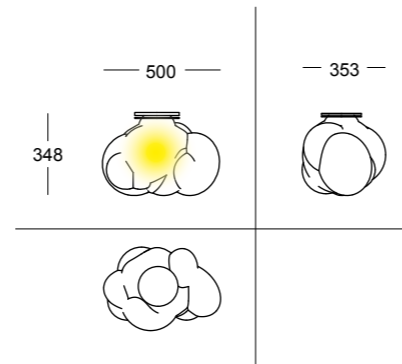

White

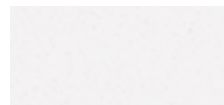

White



630/30 L

220-240V - E14 LED

Net weight 1450gr - Gross weight 2050gr

Volume m³ 0,020

CE  IP20

630/50 L

220-240V - E27 LED

Net weight 3900gr - Gross weight 5500gr

Volume m³ 0,064

CE  IP20

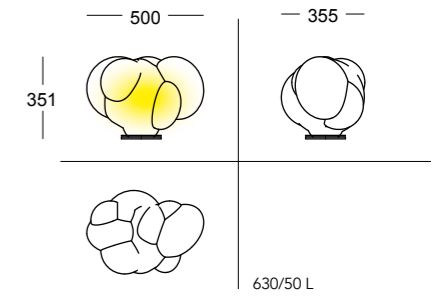
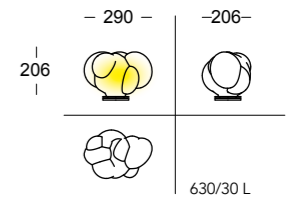

Cloud

design by Studio Tecnico Cattaneo

La sospensione Cloud è caratterizzata da una cupola in vetro centrifugato bianco. Questo design offre un aspetto elegante e moderno, mentre il vetro centrifugato aggiunge un tocco di originalità e raffinatezza.

La lampada è disponibile in due versioni: una con una singola lampadina e l'altra con tre lampadine, offrendo così la flessibilità di scegliere la soluzione che meglio si adatta alle esigenze di illuminazione e al design dell'ambiente.

Con la sua forma distintiva e la scelta di configurazioni luminose, la sospensione Cloud è in grado di aggiungere un tocco di stile e funzionalità a qualsiasi spazio.

The Cloud pendant features a white centrifuged glass dome. This design offers a sleek and modern look, while the centrifuged glass adds a touch of originality and sophistication.

The lamp is available in two versions: one with a single bulb and the other with three bulbs, offering the flexibility to choose the solution that best suits the lighting needs and design of the room.

With its distinctive shape and choice of lighting configurations, the Cloud pendant can add a touch of style and functionality to any space.

Die Cloud Pendelleuchte hat eine weiße Kuppel aus geschleudertem Glas. Dieses Design bietet einen eleganten und modernen Look, während das geschleuderte Glas einen Hauch von Originalität und Raffinesse verleiht.

Die Leuchte ist in zwei Versionen erhältlich: eine mit einer Glühbirne und eine mit drei Glühbirnen, so dass man flexibel die Lösung wählen kann, die am besten zu den Beleuchtungsbedürfnissen und dem Design des Raums passt.

Mit ihrer unverwechselbaren Form und der Auswahl an Beleuchtungskonfigurationen kann die Cloud Pendelleuchte jedem Raum einen Hauch von Stil und Funktionalität verleihen.



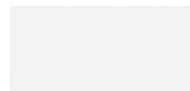

White



708/50 S

220-240V - E27 LED

Net weight 7100gr

Gross weight 8400gr

Volume 0,055 m³

Lamp supplied without lights

CE IP20

713/50 S

220-240V - 3 E27 LED

Net weight 7100gr

Gross weight 8400gr

Volume 0,055 m³

Lamp supplied without lights

CE IP20

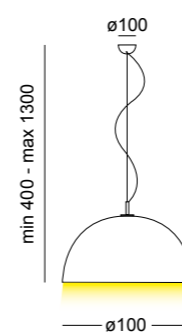

Domino

design by Studio Tecnico

La lampada a parete e plafone Domino è disponibile in tre versioni componibili, che possono essere facilmente collegate tra loro per portare la luce in qualsiasi parte della stanza.

Questo design modulare consente una flessibilità totale nella disposizione e nell'illuminazione degli ambienti. Le lampade possono essere disposte in serie o in configurazioni a griglia per adattarsi alle esigenze specifiche dello spazio.

Grazie alla loro versatilità, le lampade Domino offrono un'illuminazione personalizzabile e dinamica, consentendo di creare atmosfere uniche e accoglienti in ogni ambiente della casa.

The Domino wall and ceiling light is available in three modular versions, which can be easily linked together to bring light to any part of the room. This modular design allows for total flexibility in room layout and lighting.

Lamps can be arranged in series or grid configurations to suit the specific needs of the space.

Thanks to their versatility, Domino lamps offer customisable and dynamic lighting, allowing you to create unique and welcoming atmospheres in any room of the house.

Die Wand- und Deckenleuchte Domino ist in drei modularen Versionen erhältlich, die sich leicht miteinander verbinden lassen, um jeden Teil des Raums zu beleuchten. Dieses modulare Design ermöglicht eine vollkommene Flexibilität bei der Raumgestaltung und Beleuchtung.

Die Leuchten können in Reihen- oder Rasterkonfigurationen angeordnet werden, um den spezifischen Bedürfnissen des Raums gerecht zu werden.

Dank ihrer Vielseitigkeit bieten die Domino-Lampen eine anpassbare und dynamische Beleuchtung, die es Ihnen ermöglicht, in jedem Raum des Hauses eine einzigartige und einladende Atmosphäre zu schaffen.





Domino | Ceiling - Wall

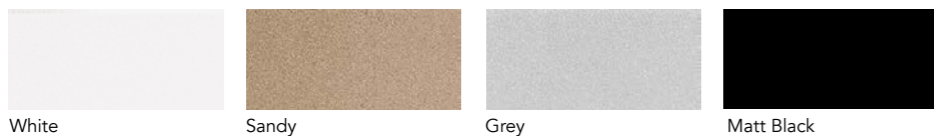

871/60 PA
 220-240V - 3 Gx53 LED
 Net weight 1860gr
 Gross weight 3400gr
 Volume 0,052 m³
 Lamp supplied without bulbs
 CE IP20

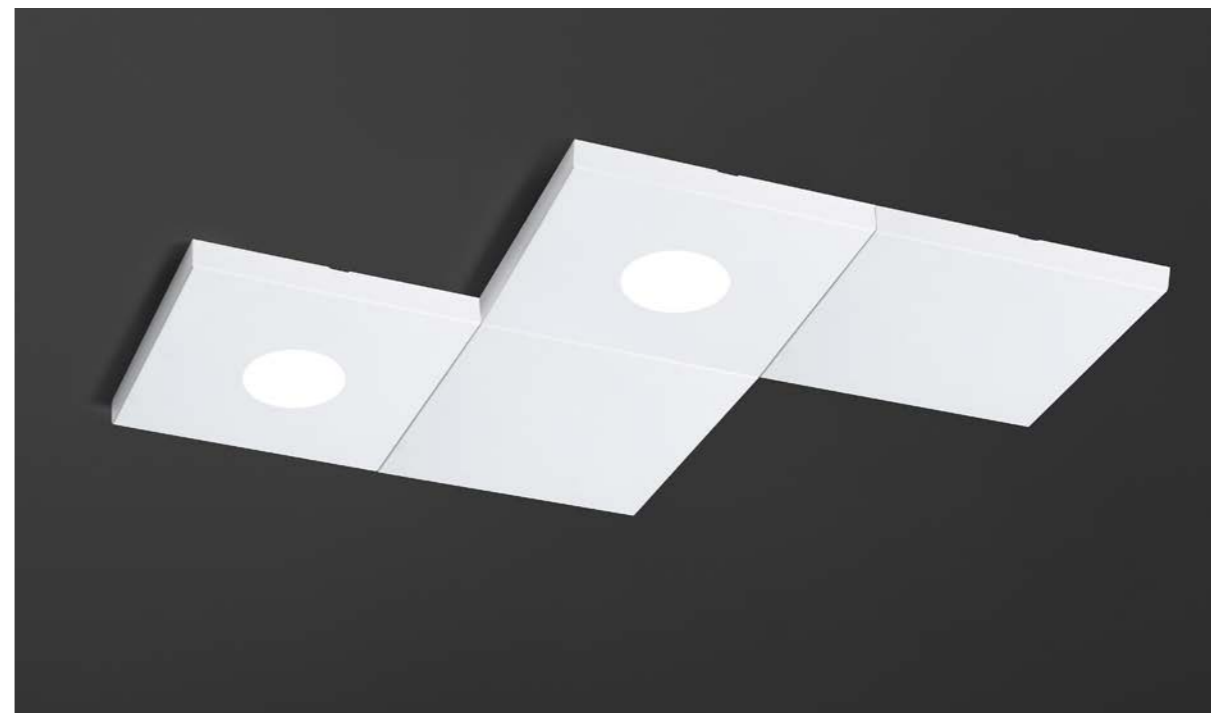
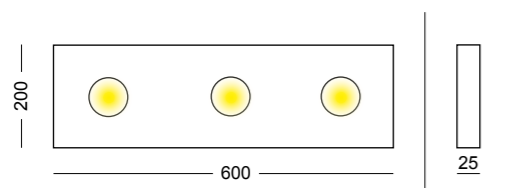

Modulo Domino

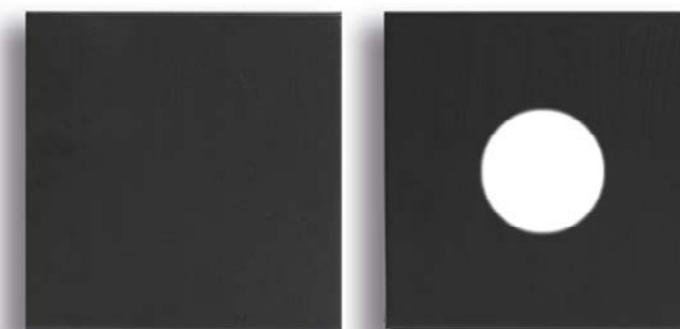

Veloce sistema di montaggio.
Unico punto luce per eseguire tutte le composizioni che si desidera.
 Fast installation system.
A single light point that can let you creating all the combinations you like.
 Schnelles Einbausystem.
Eine Leuchte mit die kann man alle Formen zusammensetzen.

872/20 C
 Net weight 790gr
 Gross weight 1125gr
 Volume 0,011 m³
 CE IP20

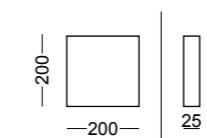

871/20 PA
 220-240V - 1 Gx53 LED
 Net weight 790gr
 Gross weight 1125gr
 Volume 0,011 m³
 Lamp supplied without bulbs
 CE IP20

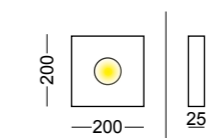

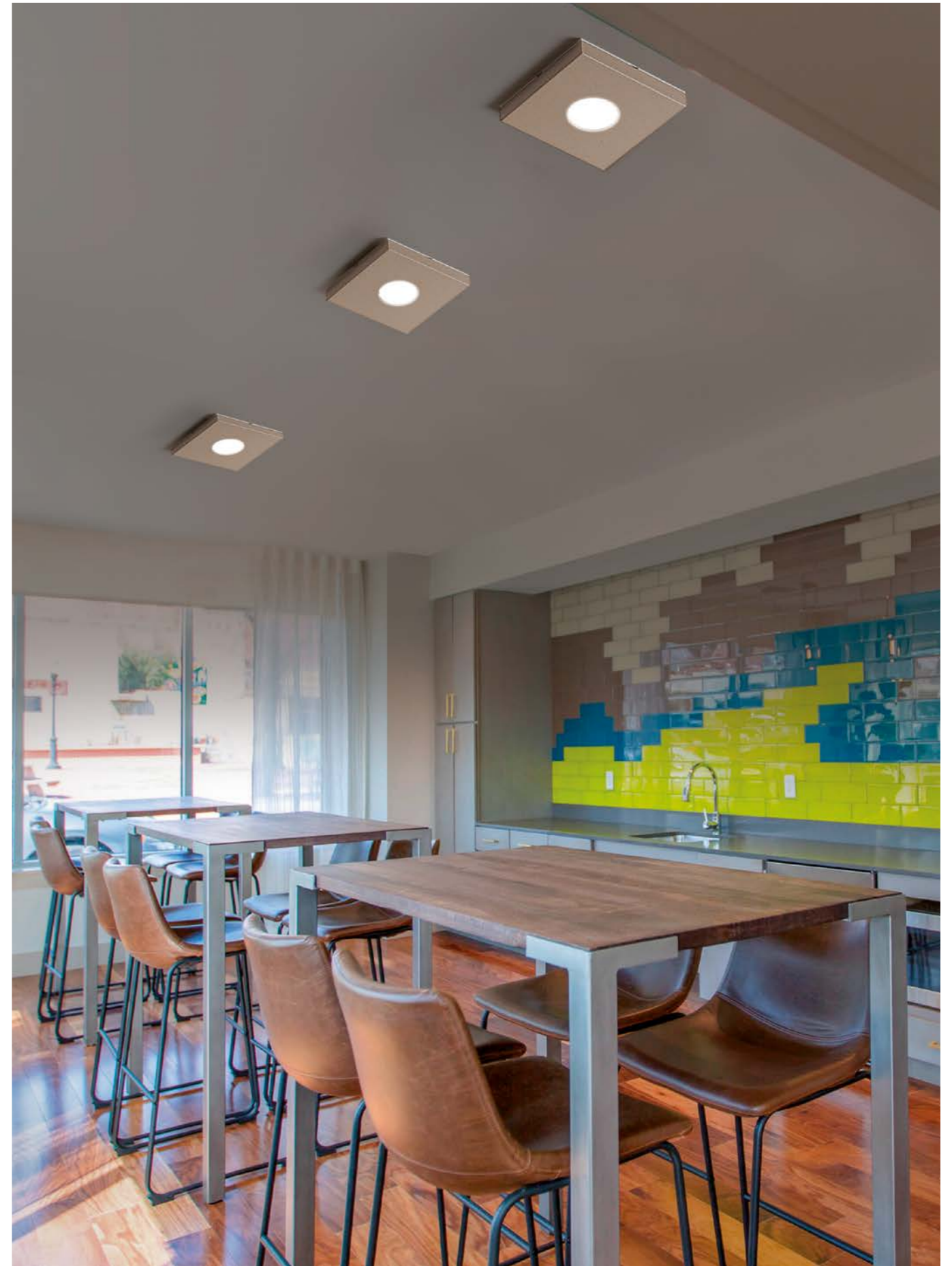
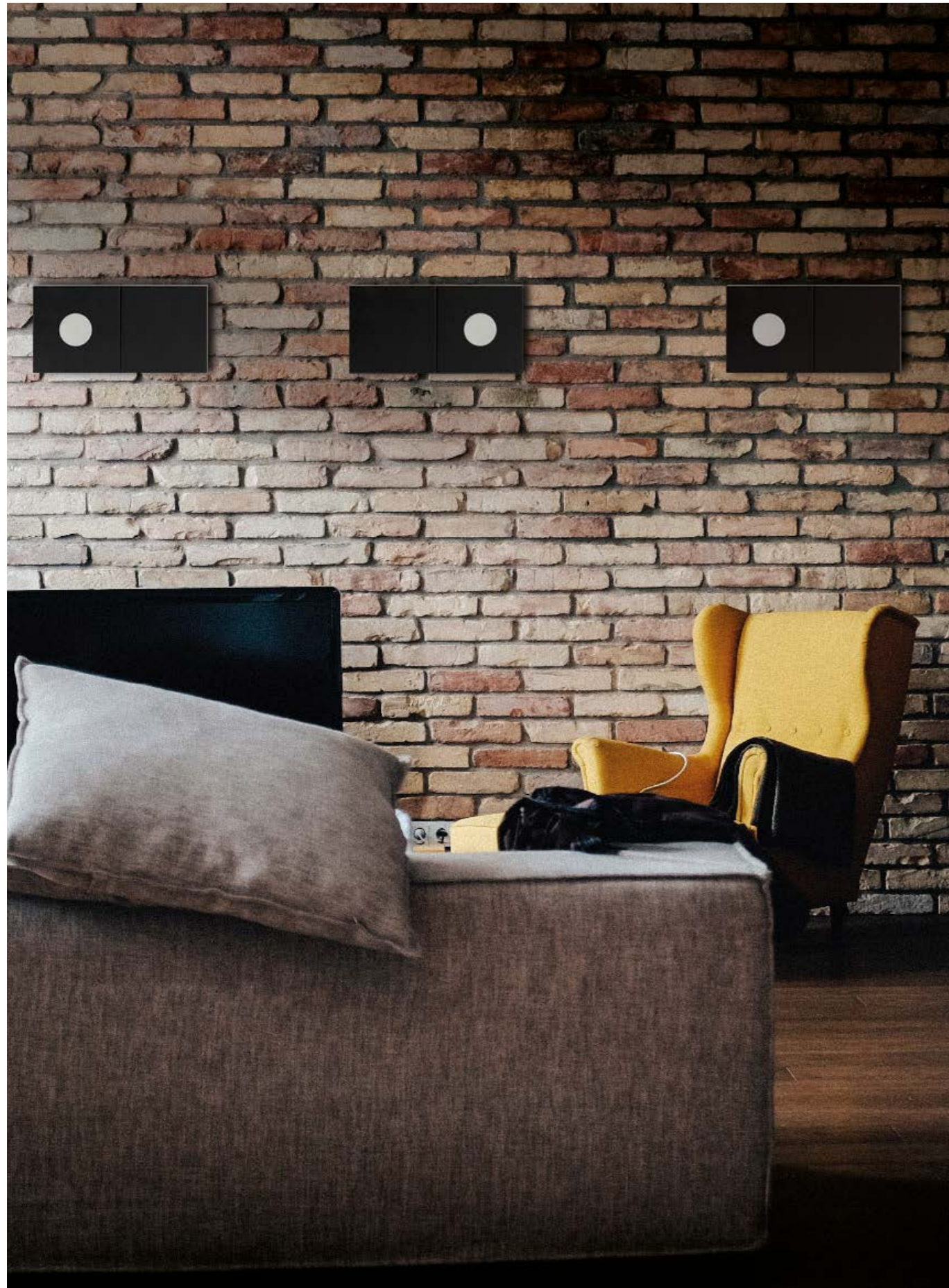

Smith

design by Studio Tecnico Cattaneo

Le lampade Smith sono un'elegante fusione di metallo brunito o lucido, con uno stile industrial chic distintivo. Disponibili in diverse varianti, tra cui sospensione, plafone o parete, queste lampade sono un'aggiunta sofisticata e funzionale a qualsiasi ambiente.

La versione a 4 luci da sospensione o plafone offre anche la flessibilità di orientare un braccio, permettendo una personalizzazione ulteriore dell'illuminazione.

Smith lamps are an elegant fusion of burnished or polished metal with a distinctive industrial chic style. Available in several variants, including pendant, ceiling or wall, these lamps are a sophisticated and functional addition to any room. The 4-light pendant or ceiling version also offers the flexibility of swivelling an arm, allowing further customisation of the lighting.

Smith-Lampen sind eine elegante Kombination aus brüniertem oder poliertem Metall und einem unverwechselbaren industriellen Stil. Erhältlich in verschiedenen Varianten, darunter Pendel-, Decken- oder Wandleuchten, sind diese Lampen eine raffinierte und funktionale Ergänzung für jeden Raum. Die 4-flammige Pendel- oder Deckenleuchte bietet außerdem die Möglichkeit, einen Arm zu schwenken, um die Beleuchtung noch individueller zu gestalten.

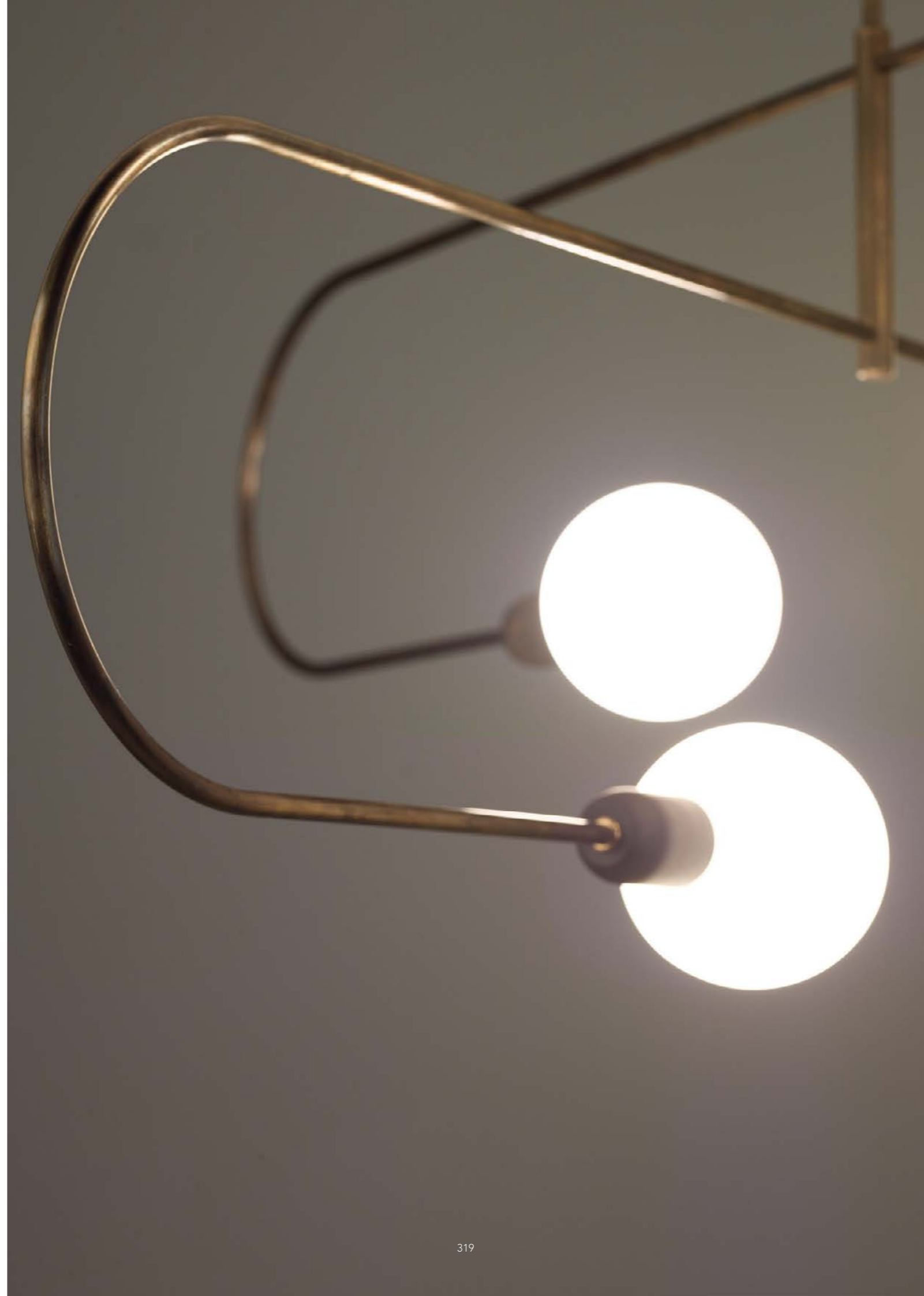



Raw Brass



Polished Brass



904/4 S

220-240V - 4 E27 LED

Net Weight 1400gr

Gross Weight 4000gr

Volume 0,11 m³

Lamp supplied without bulbs

CE IP20

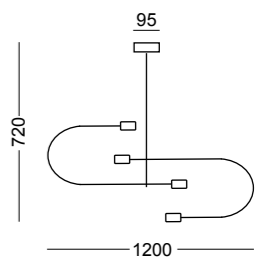



Raw Brass



Polished Brass



904/2 S
 220-240V - 2 E27 LED
 Net Weight 400gr
 Gross Weight 1400gr
 Volume 0,027 m³
 Lamp supplied without bulbs
 CE IP20

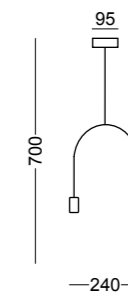



Raw Brass



Polished Brass

904/4 P

220-240V - 4 E27 LED
 Net Weight 1400gr
 Gross Weight 4000gr
 Volume 0,11 m³
 Lamp supplied without bulbs

CE IP20

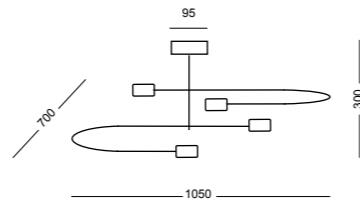

Raw Brass



Polished Brass

904/2 P

220-240V - 2 E27 LED
 aNet Weight 500gr
 Gross Weight 1050gr
 Volume 0,023 m³
 Lamp supplied without bulbs

CE IP20

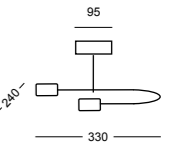





Smith | Suspension - Ceiling - Table - Wall



Raw Brass

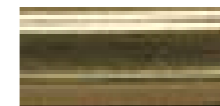

Polished Brass

904/2 A

220-240V - 2 E27 LED

Net Weight 400gr

Gross Weight 1300gr

Volume 0,027 m³

Lamp supplied without bulbs

CE IP20

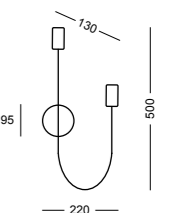

Vintage

design by C. Cattaneo

La lampada da soffitto che presentiamo è un'elegante soluzione illuminante che unisce design moderno e funzionalità versatile. Caratterizzata da una forma circolare, questa lampada si adatta perfettamente a una varietà di ambienti, portando un tocco contemporaneo a ogni spazio.

Il cuore luminoso di questa lampada è costituito da una lampadina LED GX53, che offre una luce brillante ed efficiente, perfetta per illuminare qualsiasi stanza. La tecnologia LED garantisce anche un basso consumo energetico, contribuendo a creare un ambiente sostenibile.

Un aspetto unico di questa lampada è la sua componibilità. Grazie a un astuto design, è possibile collegare più lampade tra di loro utilizzando un tubo di metallo, offrendo la flessibilità di creare configurazioni personalizzate. Questa caratteristica la rende ideale per progetti di illuminazione su larga scala o per adattarsi a diverse esigenze di spazio.

Disponibile in tre eleganti finiture, bianco, bronzo e oro satinato, questa lampada da soffitto si integra armoniosamente con qualsiasi stile di arredamento. La finitura bianca conferisce un tocco di freschezza e luminosità, il bronzo aggiunge un elemento di calore e tradizione, mentre l'oro satinato emana una raffinata eleganza.

Sia che tu stia illuminando un soggiorno, una cucina o uno spazio commerciale, questa lampada da soffitto non solo offre una luce eccezionale ma diventa anche un elemento di design che cattura l'attenzione.

The ceiling lamp we present is an elegant lighting solution that combines modern design and versatile functionality. Featuring a circular shape, this lamp fits perfectly in a variety of environments, bringing a contemporary touch to any space.

The luminous heart of this lamp is a GX53 LED bulb, which offers a bright and efficient light, perfect for illuminating any room. LED technology also ensures low energy consumption, contributing to a sustainable environment.

A unique aspect of this lamp is its modularity. Thanks to a clever design, several lamps can be connected together using a metal tube, offering the flexibility to create customised configurations. This feature makes it ideal for large-scale lighting projects or for adapting to different space requirements.

Available in three elegant finishes, white, bronze and satin gold, this ceiling light blends harmoniously with any style of décor. The white finish lends a touch of freshness and brightness, the bronze adds an element of warmth and tradition, and the satin gold exudes refined elegance.

Whether you are lighting a living room, a kitchen or a commercial space, this ceiling lamp not only provides exceptional light but also becomes an eye-catching design element.

Die hier vorgestellte Deckenleuchte ist eine elegante Beleuchtungslösung, die modernes Design und vielseitige Funktionalität vereint. Mit ihrer runden Form passt diese Lampe perfekt in eine Vielzahl von Umgebungen und verleiht jedem Raum einen modernen Touch.

Das leuchtende Herzstück dieser Lampe ist eine GX53-LED-Lampe, die ein helles und effizientes Licht bietet, das jeden Raum perfekt beleuchtet. Die LED-Technologie sorgt außerdem für einen geringen Energieverbrauch und trägt so zu einer nachhaltigen Umwelt bei.

Ein einzigartiger Aspekt dieser Leuchte ist ihre Modularität. Dank eines ausgeklügelten Konzepts können mehrere Lampen mit Hilfe eines Metallrohrs miteinander verbunden werden, was die Möglichkeit bietet, individuelle Konfigurationen zu erstellen. Diese Eigenschaft macht sie ideal für große Beleuchtungsprojekte oder für die Anpassung an unterschiedliche Raumanforderungen.

Erhältlich in den drei eleganten Oberflächen Weiß, Bronze und Gold satiniert, fügt sich diese Deckenleuchte harmonisch in jeden Einrichtungsstil ein. Die weiße Ausführung verleiht ihr einen Hauch von Frische und Helligkeit, die bronzene einen Hauch von Wärme und Tradition, und die satinierte goldene Ausführung strahlt raffinierte Eleganz aus.

Ganz gleich, ob Sie ein Wohnzimmer, eine Küche oder einen Geschäftsraum beleuchten, diese Deckenleuchte bietet nicht nur außergewöhnliches Licht, sondern wird auch zu einem auffälligen Designelement.







876/CV

ACCESSORY FOR 90° CURVE

Net weight 25gr

CE IP20



876/14 PA

220-240 V - 1 Gx53 LED

Net weight 350gr

Gross weight 850gr

Volume 0,0095 m³

Lamp supplied without bulbs

CE IP20

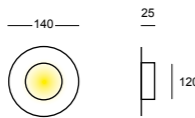

876/30 C

Net weight 60gr

Gross weight 450gr

Volume 0,012 m³

CE IP20



876/14 V

Net weight 350gr

Gross weight 850gr

Volume 0,0095 m³

CE IP20

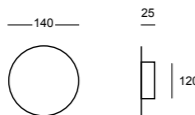

876/45 C

Net weight 80gr

Gross weight 650gr

Volume 0,014 m³

CE IP20

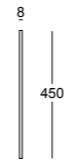

876/1 S

220-240 V - 1 E27 LED

Net weight 200gr

Gross weight 900gr

Volume 0,013 m³

Lamp supplied without bulbs

CE IP20

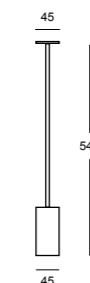

876/90 C

CE IP20

L: 8mm - H: 900mm

Net weight 160gr

Gross weight 1100gr

Volume 0,020 m³

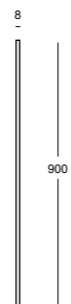

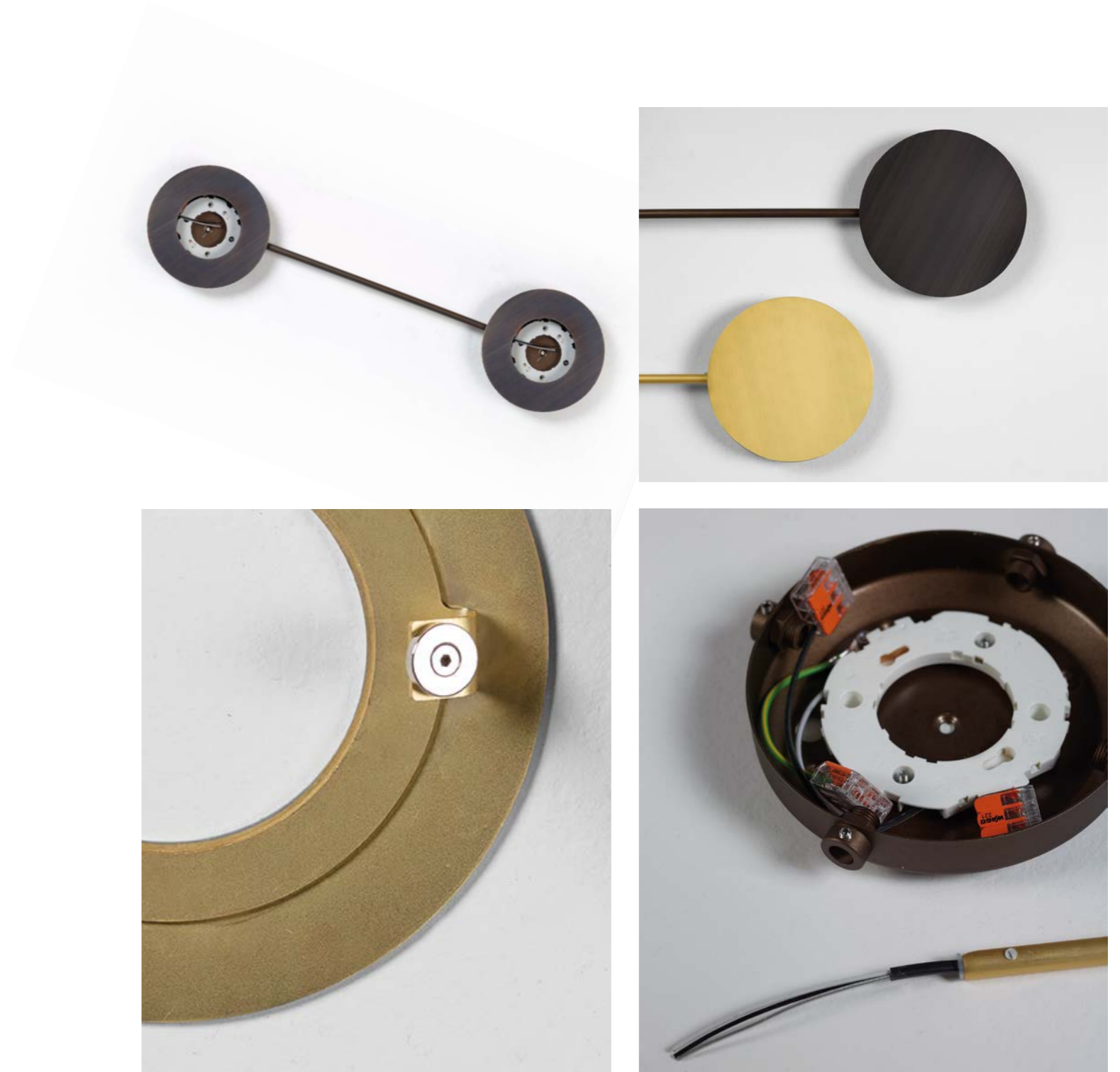

Grazie ai morsetti automatici e ai magneti integrati, l'installazione è molto semplice, garantendo una connessione stabile e affidabile. Con un design elegante e una facilità d'uso senza pari, questa lampada si distingue per la sua praticità e funzionalità

Thanks to the automatic clamps and integrated magnets, installation is very simple, ensuring a stable and reliable connection. With an elegant design and unparalleled ease of use, this lamp stands out for its practicality and functionality

Dank der automatischen Klemmen und der integrierten Magnete ist die Installation sehr einfach und gewährleistet eine stabile und zuverlässige Verbindung. Mit einem eleganten Design und einer unvergleichlichen Benutzerfreundlichkeit zeichnet sich diese Lampe durch ihre Praktikabilität und Funktionalität aus

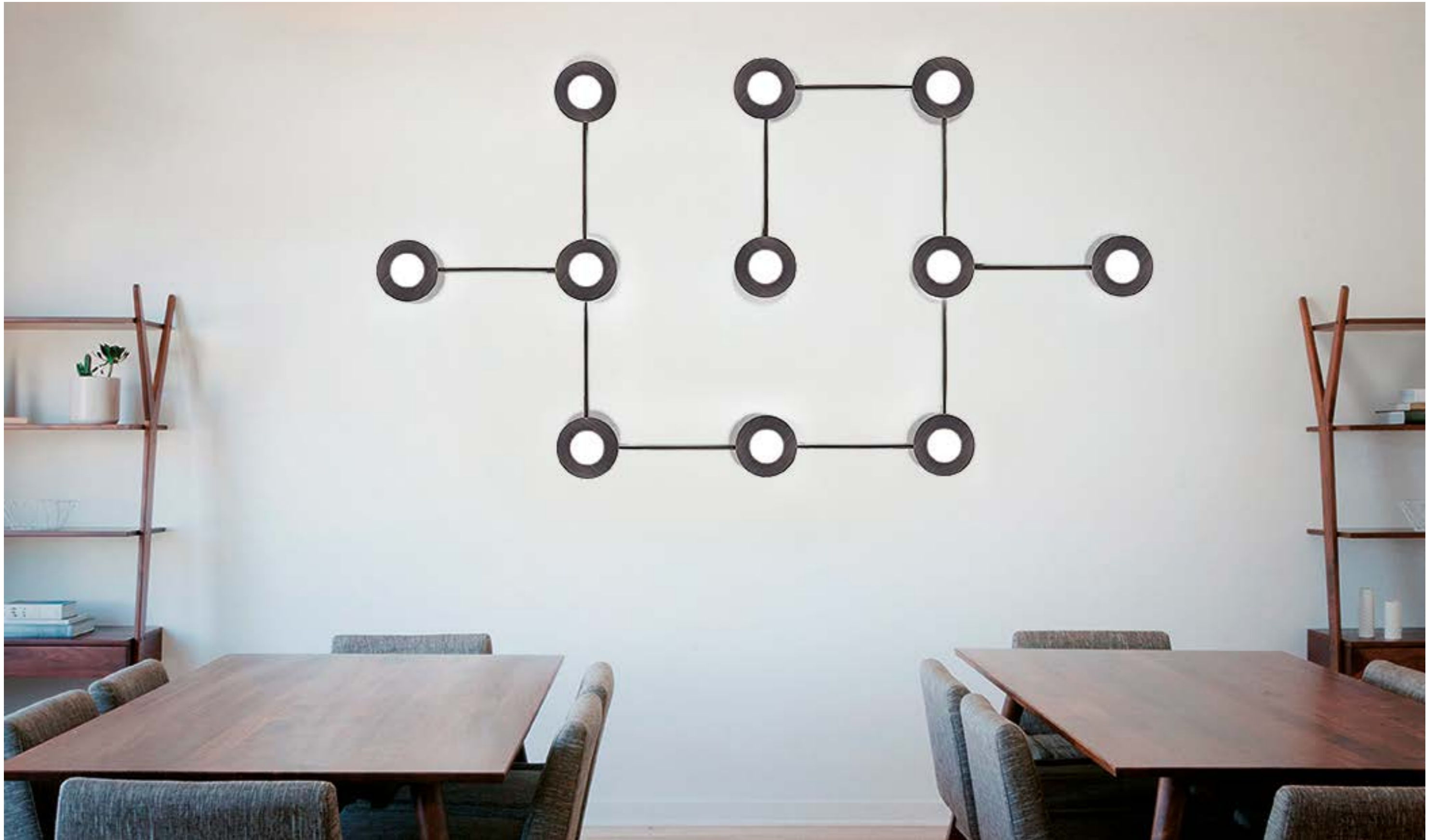

Vintage | Ceiling - Suspension - Wall



Systems collection

Lucilla System

design by C. Cattaneo

Collezione Lucilla, dove l'illuminazione diventa un'arte personalizzabile. Lucilla System rappresenta l'apice dell'innovazione nel mondo dell'illuminazione, con un sistema che si adatta alle tue esigenze in modo semplice e intuitivo.

Il cuore di Lucilla System è la sua personalizzazione senza limiti. Grazie al collegamento facile tramite jack, potrai creare configurazioni luminose su misura con un gesto. La praticità e l'efficienza si fondono, permettendoti di esplorare le potenzialità luminose del tuo spazio con estrema facilità.

Il profilo rotante a 360° di Lucilla System offre una flessibilità senza precedenti. Sperimenta la libertà di dirigere la luce in ogni direzione desiderata, creando atmosfere uniche e coinvolgenti. La versatilità di Lucilla System si espande ulteriormente con la possibilità di vari snodi per installazioni personalizzate. Ogni dettaglio è progettato per adattarsi al tuo stile e alle tue esigenze, consentendoti di creare installazioni luminose straordinarie che riflettono la tua personalità.

Sia che tu desideri illuminare un punto specifico o creare un'installazione complessa, Lucilla System è la risposta alle tue esigenze. Questa collezione è pensata per superare i confini dell'illuminazione tradizionale, portando la luce dove desideri con facilità e stile.

Lucilla Collection, where lighting becomes a customizable art. Lucilla System represents the pinnacle of innovation in the world of lighting, with a system that adapts to your needs in a simple and intuitive way.

The heart of Lucilla System is its limitless customization. Thanks to easy jack connections, you can create tailor-made lighting configurations with a simple gesture. Practicality and efficiency merge, allowing you to explore the luminous potential of your space with extreme ease.

The 360° rotating profile of Lucilla System offers unprecedented flexibility. Experience the freedom to direct light in every desired direction, creating unique and engaging atmospheres. The versatility of Lucilla System expands further with the possibility of various joints for customized installations. Every detail is designed to adapt to your style and needs, enabling you to create extraordinary lighting installations that reflect your personality.

Whether you want to illuminate a specific point or create a complex installation, Lucilla System is the answer to your needs. This collection is designed to transcend the boundaries of traditional lighting, bringing light where you want it with ease and style.

Lucilla-Kollektion, wo Beleuchtung zu einer anpassbaren Kunst wird. Lucilla System repräsentiert die Spitze der Innovation in der Welt der Beleuchtung, mit einem System, das sich auf einfache und intuitive Weise an Ihre Bedürfnisse anpasst.

Das Herzstück von Lucilla System ist seine grenzenlose Anpassungsfähigkeit. Dank einfacher Jack-Verbindungen können Sie mit einer einfachen Geste maßgeschneiderte Beleuchtungskonfigurationen erstellen. Praktikabilität und Effizienz verschmelzen und ermöglichen es Ihnen, das luminöse Potenzial Ihres Raums mit äußerster Leichtigkeit zu erkunden.

Das 360°-drehbare Profil von Lucilla System bietet beispiellose Flexibilität. Erleben Sie die Freiheit, das Licht in jede gewünschte Richtung zu lenken und einzigartige, fesselnde Atmosphären zu schaffen. Die Vielseitigkeit von Lucilla System erweitert sich weiter durch die Möglichkeit verschiedener Gelenke für maßgeschneiderte Installationen. Jedes Detail ist darauf ausgelegt, sich Ihrem Stil und Ihren Bedürfnissen anzupassen und Ihnen die Möglichkeit zu bieten, außergewöhnliche Beleuchtungsinstallationen zu schaffen, die Ihre Persönlichkeit widerspiegeln.

Egal, ob Sie einen bestimmten Punkt beleuchten oder eine komplexe Installation erstellen möchten, Lucilla System ist die Antwort auf Ihre Bedürfnisse. Diese Kollektion ist darauf ausgelegt, die Grenzen der traditionellen Beleuchtung zu überschreiten und Licht mit Leichtigkeit und Stil dorthin zu bringen, wo Sie es möchten.







938/200 S

LED 56W 24V 220-240V
 5600lm-3000°K upon request 2700-4000°K
 Net weight 3100gr - Gross weight 4500gr
 Volume m³ 0.06

Dimmable **PUSH**
 IP20

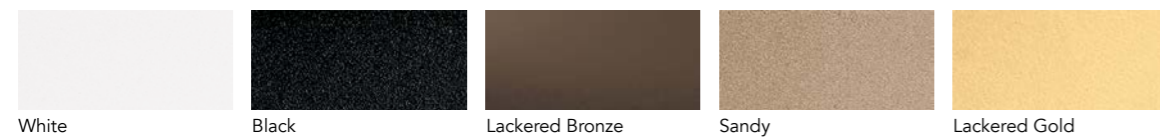
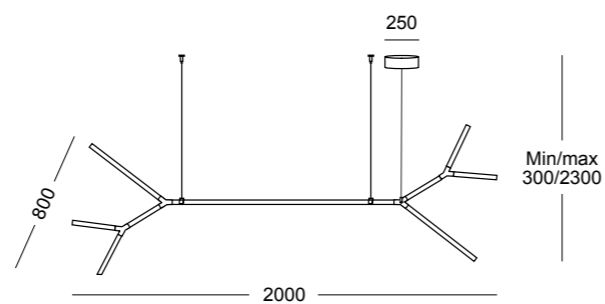

**A richiesta tutte le misure possono essere personalizzate.
 On demand all sizes can be customised.
 Alle Größen können auf Anfrage personalisiert werden.**



938/160 S

LED 40W 24V Dc 220 - 240V
 4000lm 3000°K upon request 2700°/4000°K
 Net weight 1600gr - Gross weight 3000gr
 Volume m³ 0.06

Dimmable **PUSH**
 IP20

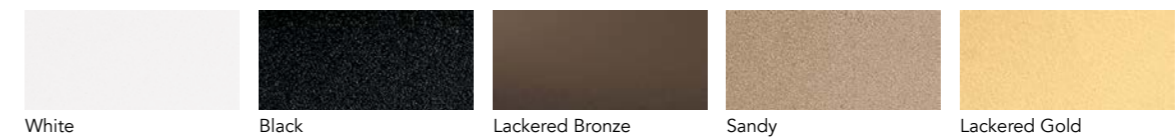
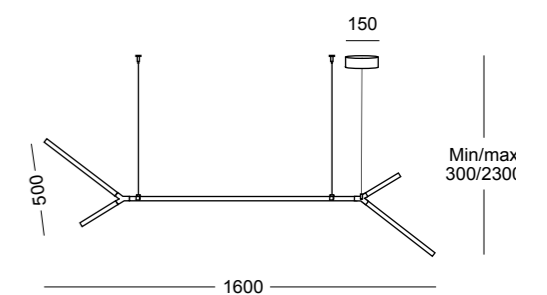

**A richiesta tutte le misure possono essere personalizzate.
 On demand all sizes can be customised.
 Alle Größen können auf Anfrage personalisiert werden.**

938/100 S

LED 26W 24V Dc 220 - 240V

2600lm 3000°K upon request 2700°/4000°K

Net weight 1360gr - Gross weight 2500gr

Volume m³ 0.06

 PUSH

 IP20

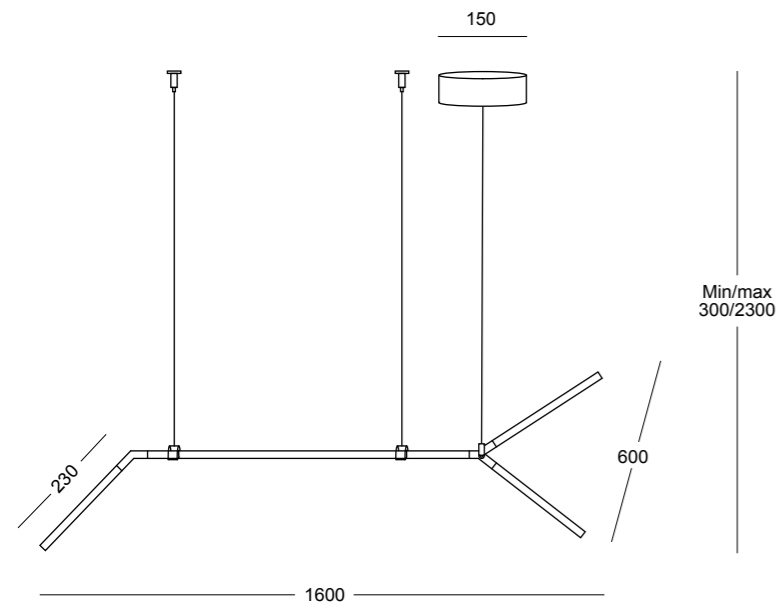

A richiesta tutte le misure possono essere personalizzate.
All sizes can be customized upon request.
Alle Größen können auf Anfrage personalisiert werden.

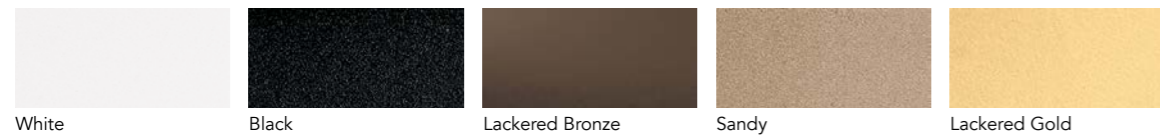

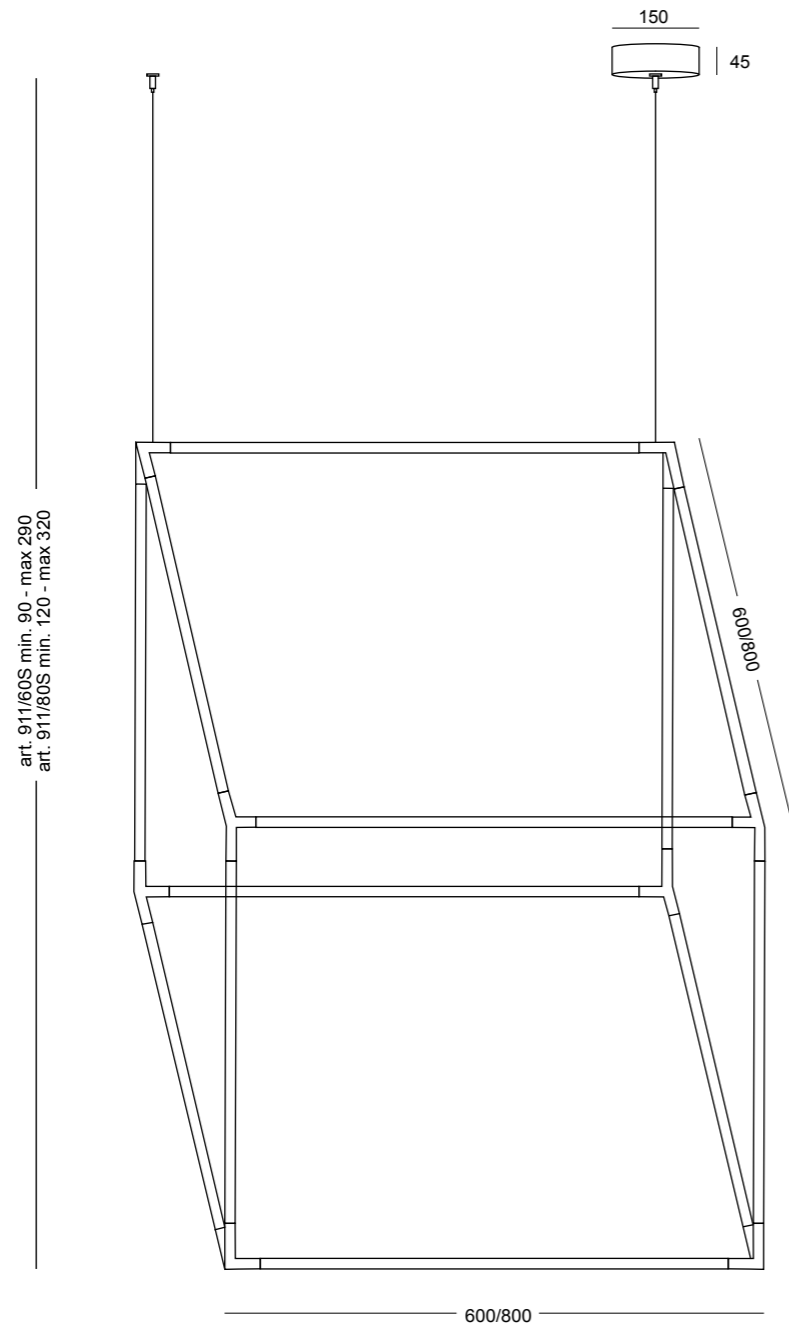

911/60S

LED 140W 24V Dc 220 - 240V
 14000lm 3000°K upon request 2700°/4000°K
 Net weight 4200gr - Gross weight 6200gr
 Volume m³ 0.06



CE IP20

911/80S

LED 188W 24V Dc 220 - 240V
 19200lm 3000°K upon request 2700°/4000°K
 Net weight 5000gr - Gross weight 7500gr
 Volume m³ 0.06



CE IP20

A richiesta tutte le misure possono essere personalizzate.
All sizes can be customized upon request.
Alle Größen können auf Anfrage personalisiert werden.

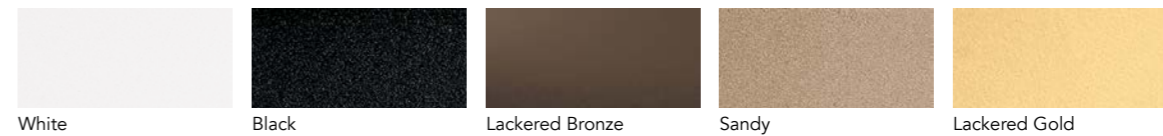
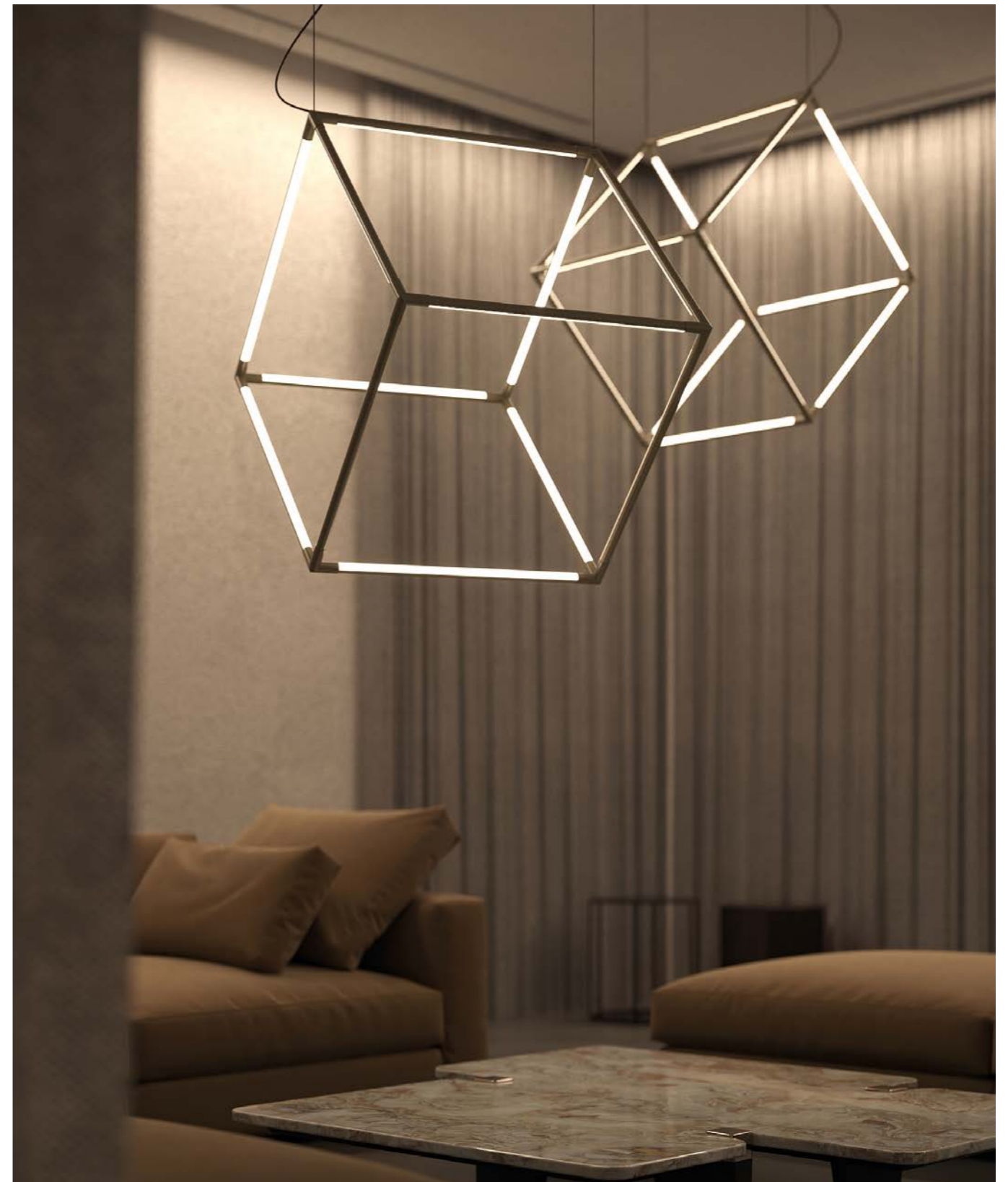



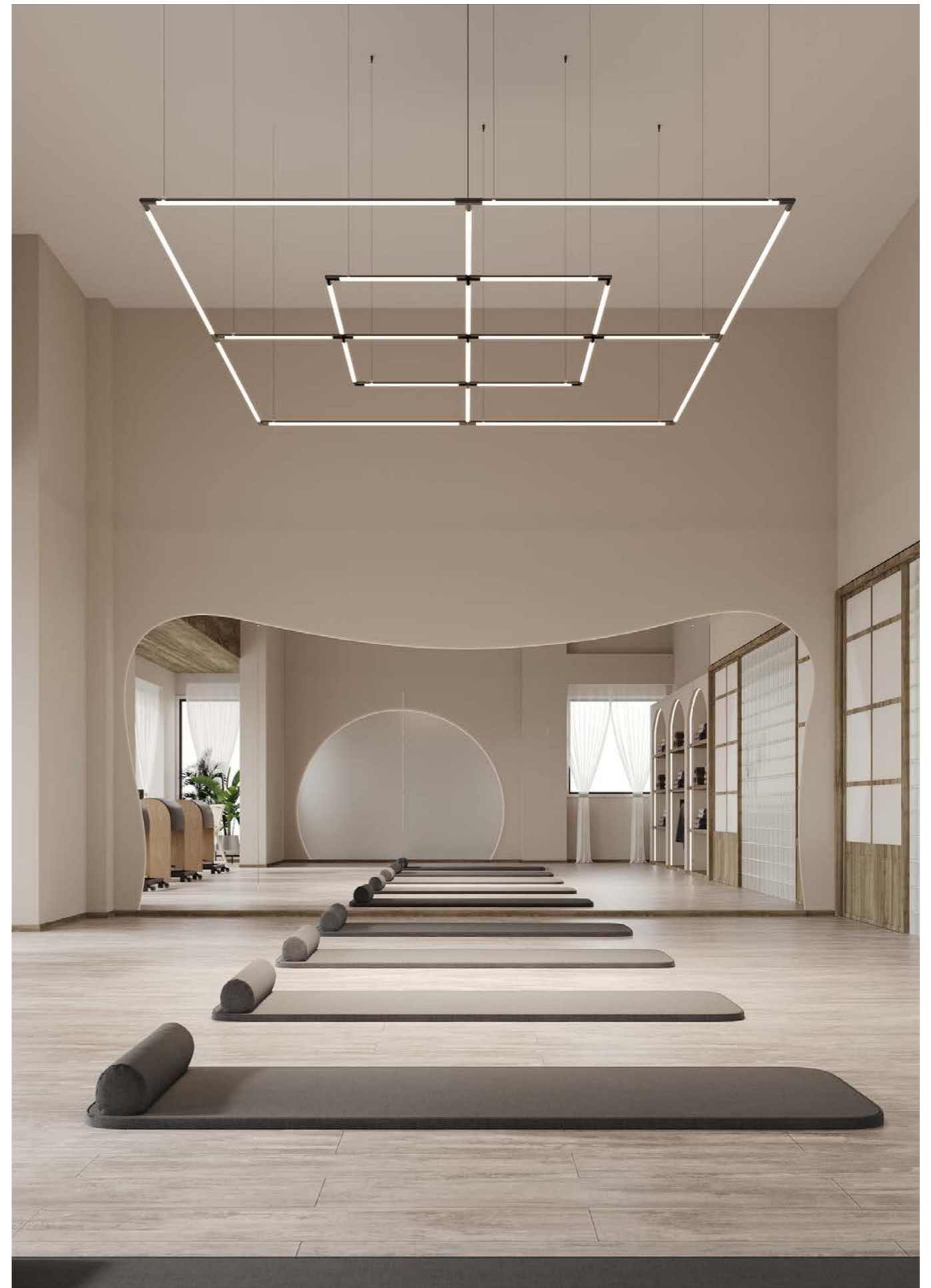









Esempi d'installazione personalizzata

Examples of customized installation - Beispiele für kundenspezifische Installationen

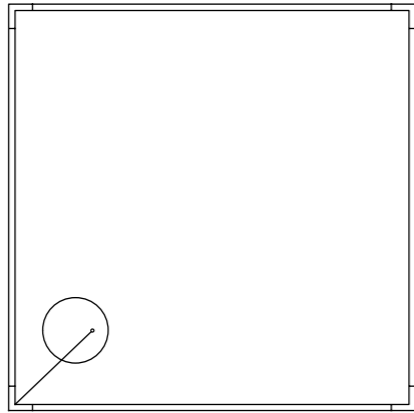

Module S905/L
N°1 pz

Module S906/L
N°3 pz



Module 907/25R



Module 908/B
N°4 pz



Module 905/80PR
N°4 pz

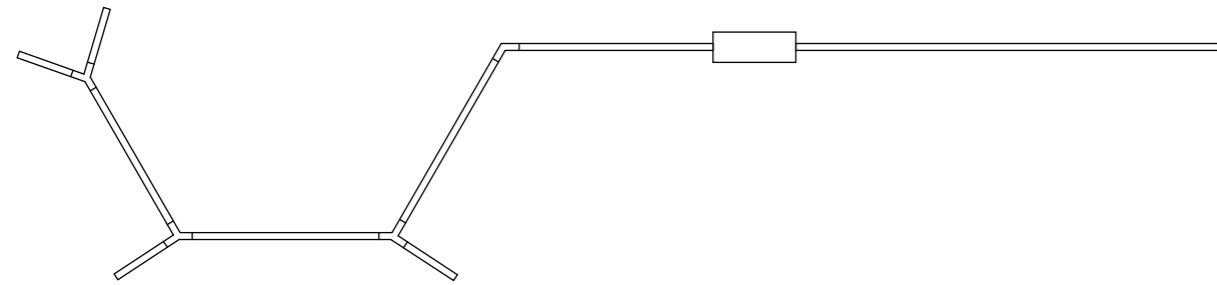

Module S906/E
N°1 pz

Module 906/B
N°3 pz



Module 908/2R
N°1 pz



Module 908/A
N°9 pz



Module
1 - 906/60PR
1 - 906/50PR
2 - 906/40PR



Module
1 - 905/2000PR
4 - 905/20PR

Lucilla System

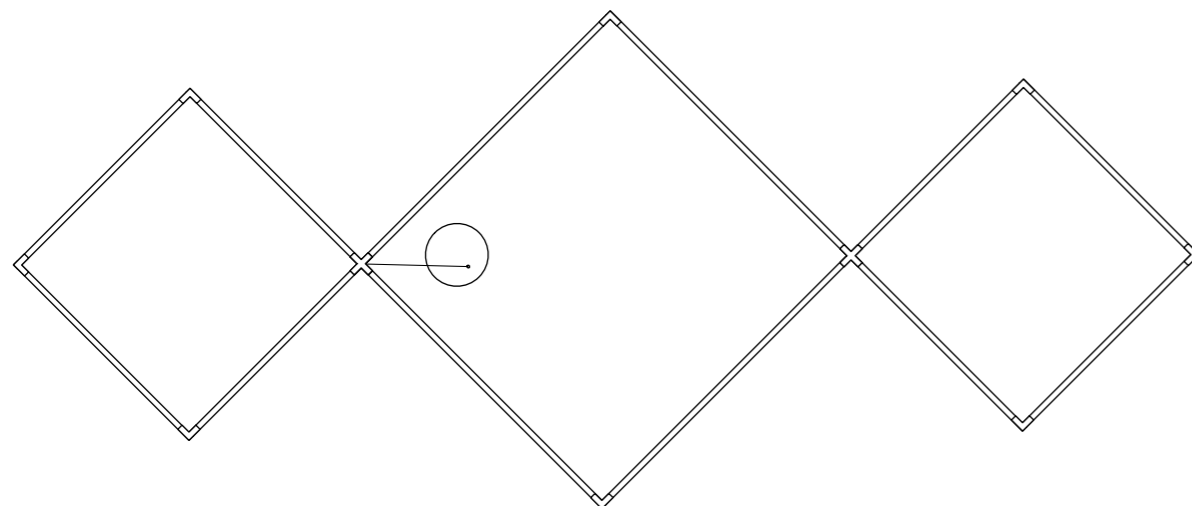

Module S906/L
N°8 pz

Module S906/C
N°1 pz

Module S905/C
N°1 pz



Module 907/25R



Module 908/B
N°10 pz



Module 906/50PR
N°8 pz







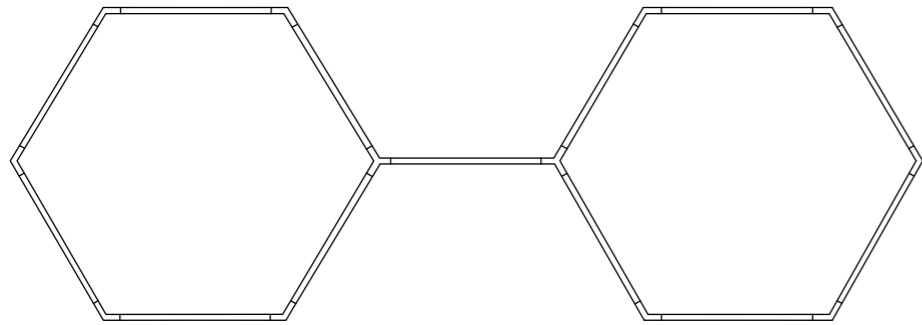

Module 906/70PR
N°4 pz





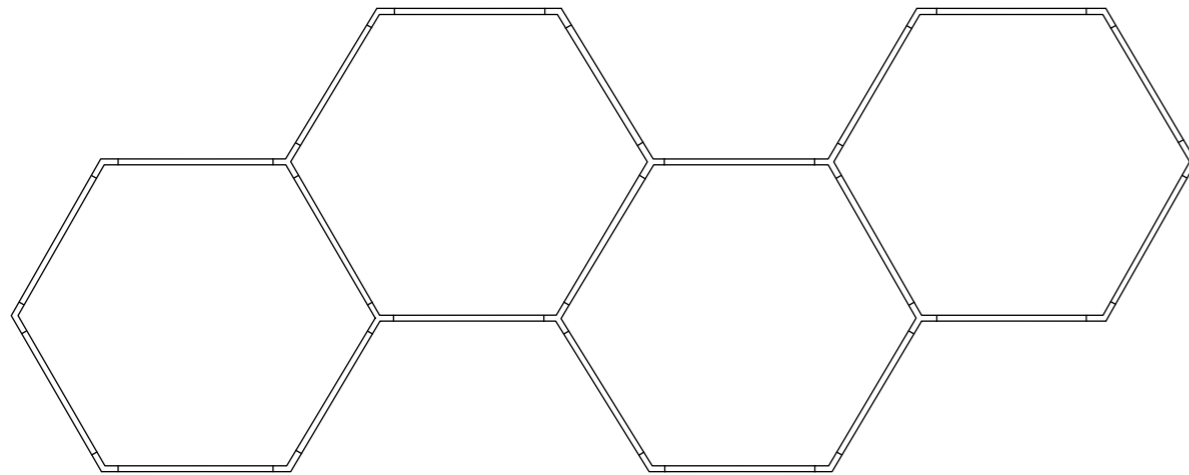

Esempi d'installazione personalizzata

Examples of customized installation - Beispiele für kundenspezifische Installationen







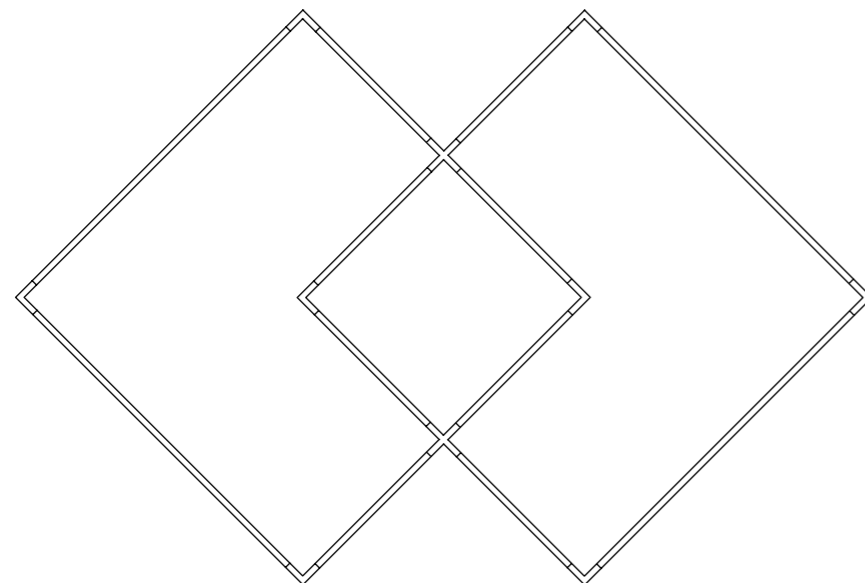

- 
Module S906/E
N°10 pz
- 
Module 906/B
N°1 pz
- 
Module 905/B
N°1 pz
- 
Module 907/25R
- 
Module 908/A
N°13 pz
- 
Module 906/50PR
N°13 pz



- 
Module S906/E
N°12 pz
- 
Module S905/B
N°4 pz
- 
Module 905/B
N°2 pz
- 
Module 907/25R
N°2 pz
- 
Module 908/A
N°21 pz
- 
Module 906/60PR
N°21 pz



- 
Module 906/L
N°7 pz
- 
Module 905/L
N°1 pz
- 
Module S906/C
N°2 pz
- 
Module 907/25R
N°2 pz
- 
Module 908/B
N°6 pz
- 
Module 906/30PR
N°8 pz
- 
Module 906/60PR
N°4 pz

Esempi d'installazione personalizzata

Examples of customized installation - Beispiele für kundenspezifische Installationen

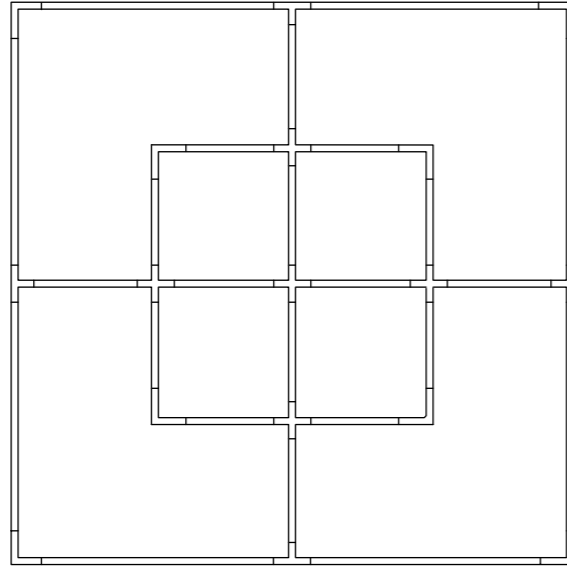

Module 906/L
N°7 pz



Module 905/L
N°1 pz



Module S906/T
N°4 pz



Module S906/C
N°4 pz



Module S905/C
N°1 pz



Module 907/25R
N°2 pz



Module 908/B
N°8 pz



Module 906/30PR
N°16 pz



Module 906/60PR
N°8 pz

Colori disponibili in tutte le installazioni

Colors available in all installations - Farben in allen Installationen verfügbar

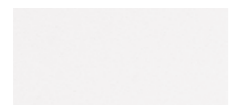

White



Black



Lackered Bronze



Sandy



Lackered Gold



Esempi d'installazione personalizzata

Examples of customised installation - Beispiele für kundenspezifische Installationen

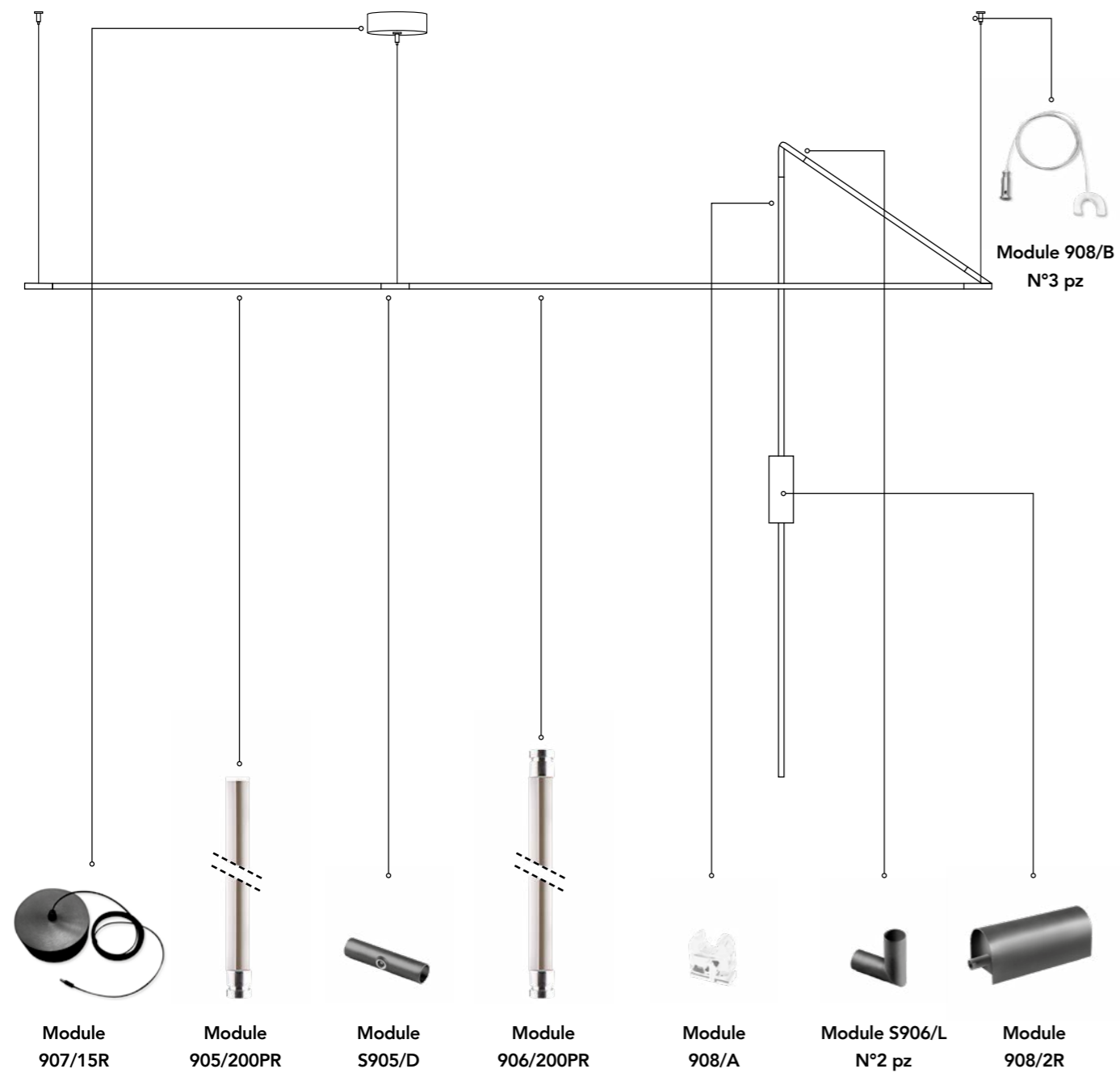

A richiesta tutte le misure possono essere personalizzate.
 On demand all sizes can be customised.
 Alle Größen können auf Anfrage personalisiert werden.

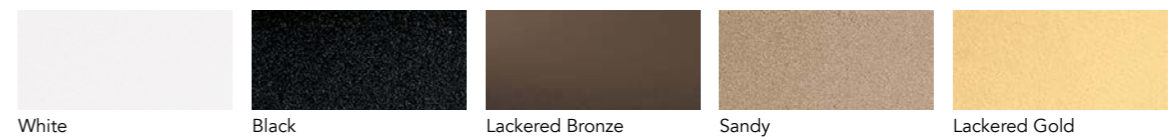
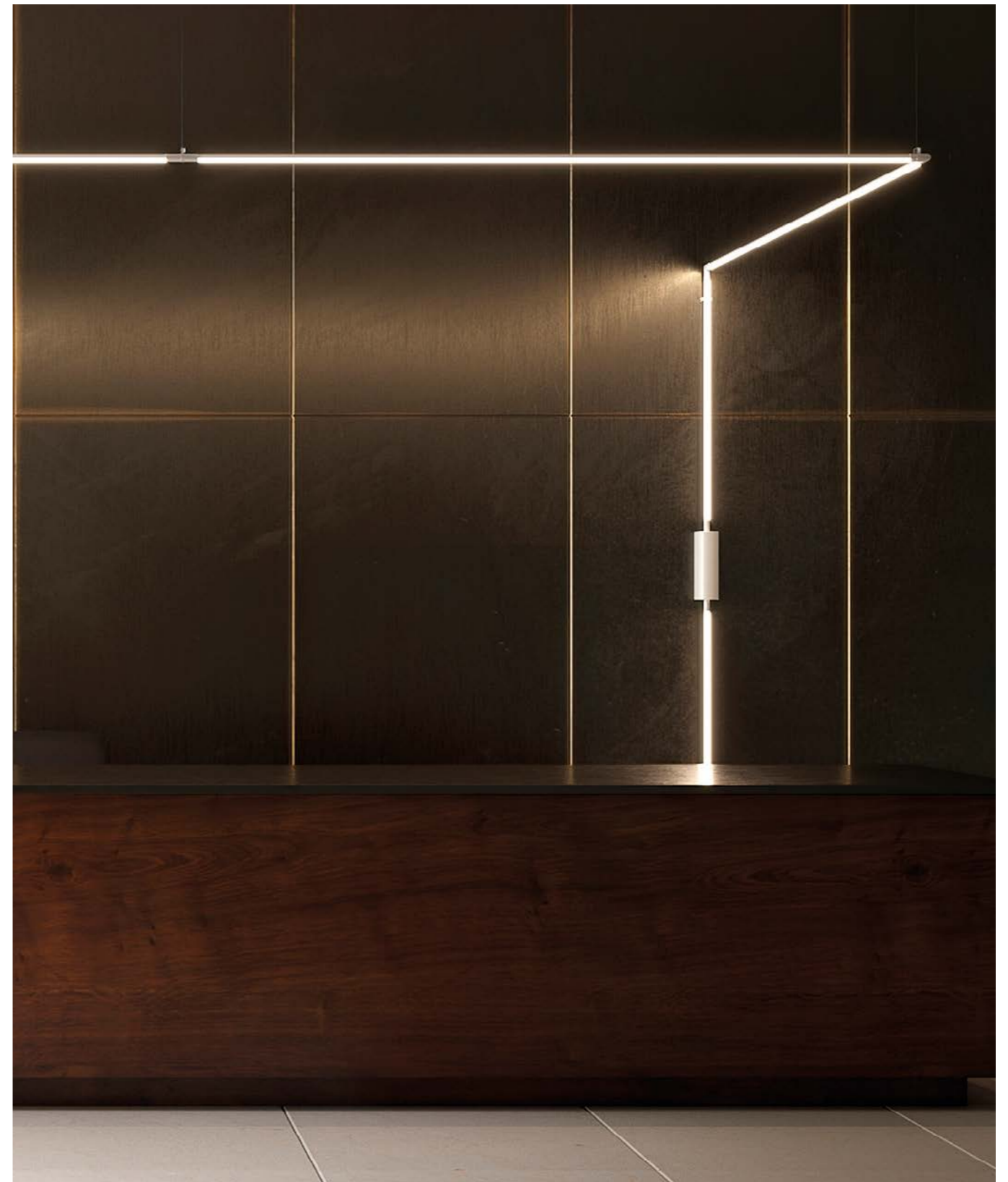

939/100SP

LED 26W 24V Dc 220 - 240V

2600lm 3000°K upon request 2700°/4000°K

Net weight 1260gr - Gross weight 1950r

Volume m³ 0.108

 PUSH

  IP20

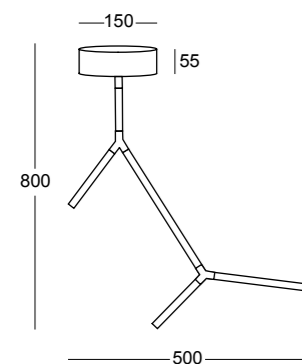

Lucilla System

**A richiesta tutte le misure possono essere personalizzate.
On demand all sizes can be customised.
Alle Größen können auf Anfrage personalisiert werden.**

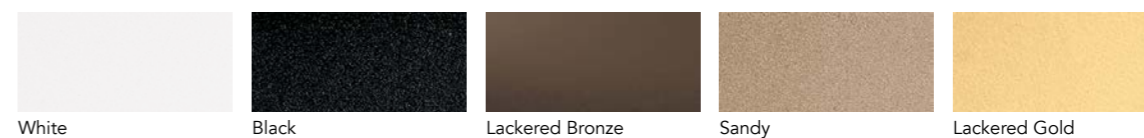



910/1S

LED 44W 24V Dc 220 - 240V
 19200lm 3000°K upon request 2700°/4000°K
 Net weight 1390gr - Gross weight 2000gr
 Volume m³ 0.108
 Dimmable PUSH
 CE IP20

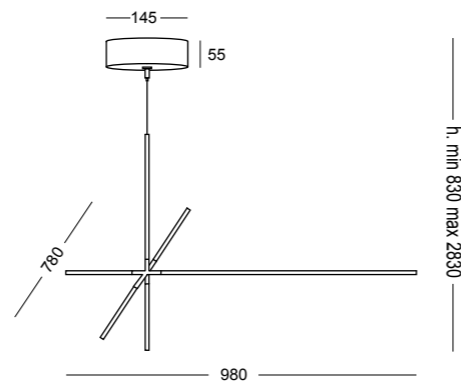

910/1P

LED 44W 24V Dc 220 - 240V
 19200lm 3000°K upon request 2700°/4000°K
 Net weight 1390gr - Gross weight 2000gr
 Volume m³ 0.108
 Dimmable PUSH
 CE IP20

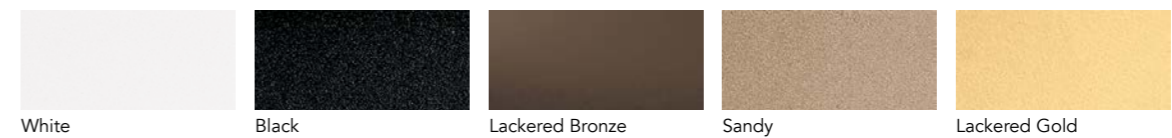
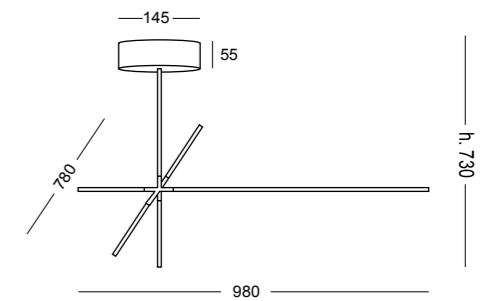

Moduli



Module

- 905/20PR LED 3,92W 24V 400lm Net weight 74.0gr
- 905/30PR LED 5,88W 24V 600lm Net weight 96.5gr
- 905/40PR LED 7,84W 24V 800lm Net weight 118.5gr
- 905/50PR LED 9,8W 24V 1000lm Net weight 141.0gr
- 905/60PR LED 11,76W 24V 1200lm Net weight 163.5gr
- 905/70PR LED 13,72W 24V 1400lm Net weight 186.0gr
- 905/80PR LED 15,68W 24V 1600lm Net weight 208.5gr
- 905/90PR LED 17,64W 24V 1800lm Net weight 231.0gr
- 905/100PR LED 19,6W 24V 2000lm Net weight 253.5gr
- 905/110PR LED 21,56W 24V 2200lm Net weight 276.0gr
- 905/120PR LED 23,52W 24V 2400lm Net weight 298.5gr
- 905/130PR LED 25,48W 24V 2600lm Net weight 321.0gr
- 905/140PR LED 27,44W 24V 2800lm Net weight 343.5gr
- 905/150PR LED 29,4W 24V 3000lm Net weight 366.0gr
- 905/160PR LED 31,36W 24V 3200lm Net weight 388.5gr
- 905/170PR LED 33,32W 24V 3400lm Net weight 411.0gr
- 905/180PR LED 35,28W 24V 3600lm Net weight 433.5gr
- 905/190PR LED 37,24W 24V 3800lm Net weight 456.0gr
- 905/200PR LED 39,2W 24V 4000lm Net weight 478.5gr

Module

- 906/20PR LED 3,92W 24V 400lm Net weight 90.5gr
- 906/30PR LED 5,88W 24V 600lm Net weight 112.5gr
- 906/40PR LED 7,84W 24V 800lm Net weight 134.5gr
- 906/50PR LED 9,8W 24V 1000lm Net weight 156.5gr
- 906/60PR LED 11,76W 24V 1200lm Net weight 178.5gr
- 906/70PR LED 13,72W 24V 1400lm Net weight 200.5gr
- 906/80PR LED 15,68W 24V 1600lm Net weight 222.5gr
- 906/90PR LED 17,64W 24V 1800lm Net weight 244.5gr
- 906/100PR LED 19,6W 24V 2000lm Net weight 266.5gr
- 906/110PR LED 21,56W 24V 2200lm Net weight 288.5gr
- 906/120PR LED 23,52W 24V 2400lm Net weight 310.5gr
- 906/130PR LED 25,48W 24V 2600lm Net weight 332.5gr
- 906/140PR LED 27,44W 24V 2800lm Net weight 354.5gr
- 906/150PR LED 29,4W 24V 3000lm Net weight 376.5gr
- 906/160PR LED 31,36W 24V 3200lm Net weight 398.5gr
- 906/170PR LED 33,32W 24V 3400lm Net weight 420.5gr
- 906/180PR LED 35,28W 24V 3600lm Net weight 442.5gr
- 906/190PR LED 37,24W 24V 3800lm Net weight 464.5gr
- 906/200PR LED 39,2W 24V 4000lm Net weight 486.5gr

3000°K upon request 2700/4000°K



Montaggio facile con innesto jack che consente una rapida installazione.
Grazie alla sua versatilità si può ruotare e creare scenari con luce diretta e/o indiretta.

Easy mounting with a jack plug that allows for quick installation.
Thanks to its versatility, it can be tilted, rotated and create scenarios with direct and/or indirect light.

Einfache Montage mit einem Jack-Stecker, der eine schnelle Installation ermöglicht.
Dank ihrer Vielseitigkeit kann sie gekippt und gedreht werden und Szenarien mit direktem und/oder indirektem Licht schaffen.

Moduli senza ingresso alimentazione - Module without Stromeingang - Module ohne Stromeingang



- Module S906/D**
Ø20-h90
net weight 55gr
- Module S906/L**
Ø20-h53x53
net weight 50gr
- Module S906/T**
Ø20-h90x53
net weight 75gr
- Module S906/A**
Ø20-h53x53x53
net weight 78gr
- Module S906/C**
Ø20-h90x90
net weight 98gr
- Module S906/DC**
Ø20-h110x90
net weight 156gr
- Module S906/B**
Ø20-h103
net weight 89gr
- Module S906/E**
Ø20-h90
net weight 56gr

Moduli con ingresso alimentazione - Module mit Stromeingang - Module mit Stromeingang

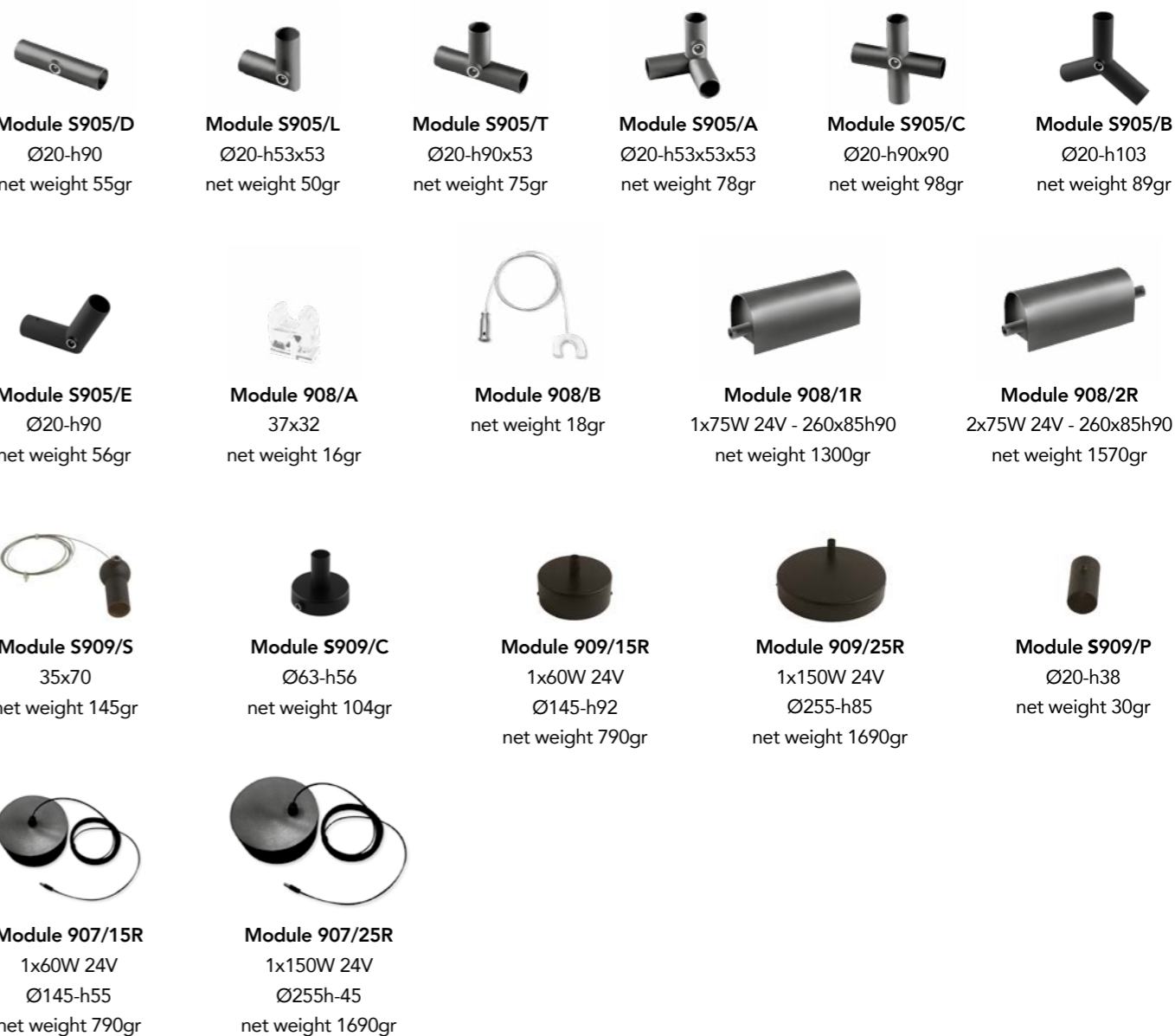

- Module S905/D**
Ø20-h90
net weight 55gr
- Module S905/L**
Ø20-h53x53
net weight 50gr
- Module S905/T**
Ø20-h90x53
net weight 75gr
- Module S905/A**
Ø20-h53x53x53
net weight 78gr
- Module S905/C**
Ø20-h90x90
net weight 98gr
- Module S905/B**
Ø20-h103
net weight 89gr
- Module S905/E**
Ø20-h90
net weight 56gr
- Module 908/A**
37x32
net weight 16gr
- Module 908/B**
net weight 18gr
- Module 908/1R**
1x75W 24V - 260x85h90
net weight 1300gr
- Module 908/2R**
2x75W 24V - 260x85h90
net weight 1570gr
- Module S909/S**
35x70
net weight 145gr
- Module S909/C**
Ø63-h56
net weight 104gr
- Module 909/15R**
1x60W 24V
Ø145-h92
net weight 790gr
- Module 909/25R**
1x150W 24V
Ø255-h85
net weight 1690gr
- Module S909/P**
Ø20-h38
net weight 30gr
- Module 907/15R**
1x60W 24V
Ø145-h55
net weight 790gr
- Module 907/25R**
1x150W 24V
Ø255h-45
net weight 1690gr

Lucilla floor

design by C. Cattaneo

Lucilla, elegante e lineare, è la lampada da terra adatta ad ogni ambiente. Disponibile singola o doppia con altezze diverse, è dotata di dimmer per illuminare l'ambiente in base alle proprie preferenze. Grazie alla sua versatilità si può inclinare, ruotare e creare scenari con luce diretta e/o indiretta.

Lucilla, elegant and linear, is the floor lamp suitable for any environment. Available as a single or double lamp with different heights, it is equipped with a dimmer to light the room according to your preferences. Thanks to its versatility, it can be tilted, rotated and create scenarios with direct and/or indirect light.

Lucilla, elegant und linear, ist die Stehleuchte, die sich für jede Umgebung eignet. Sie ist als Einzel- oder Doppelleuchte in verschiedenen Höhen verfügbar und mit einem Dimmer ausgestattet, um den Raum nach den eigenen Vorlieben zu beleuchten. Wegen ihrer Vielseitigkeit kann sie gekippt und gedreht werden und Szenarien mit direktem und/oder indirektem Licht schaffen.





Lucilla | Floor

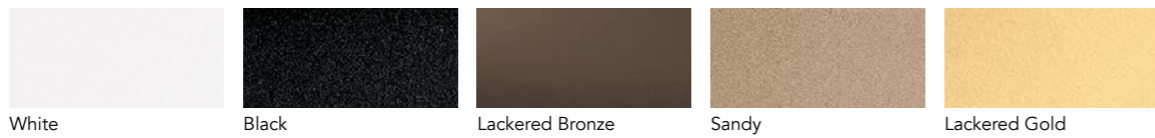
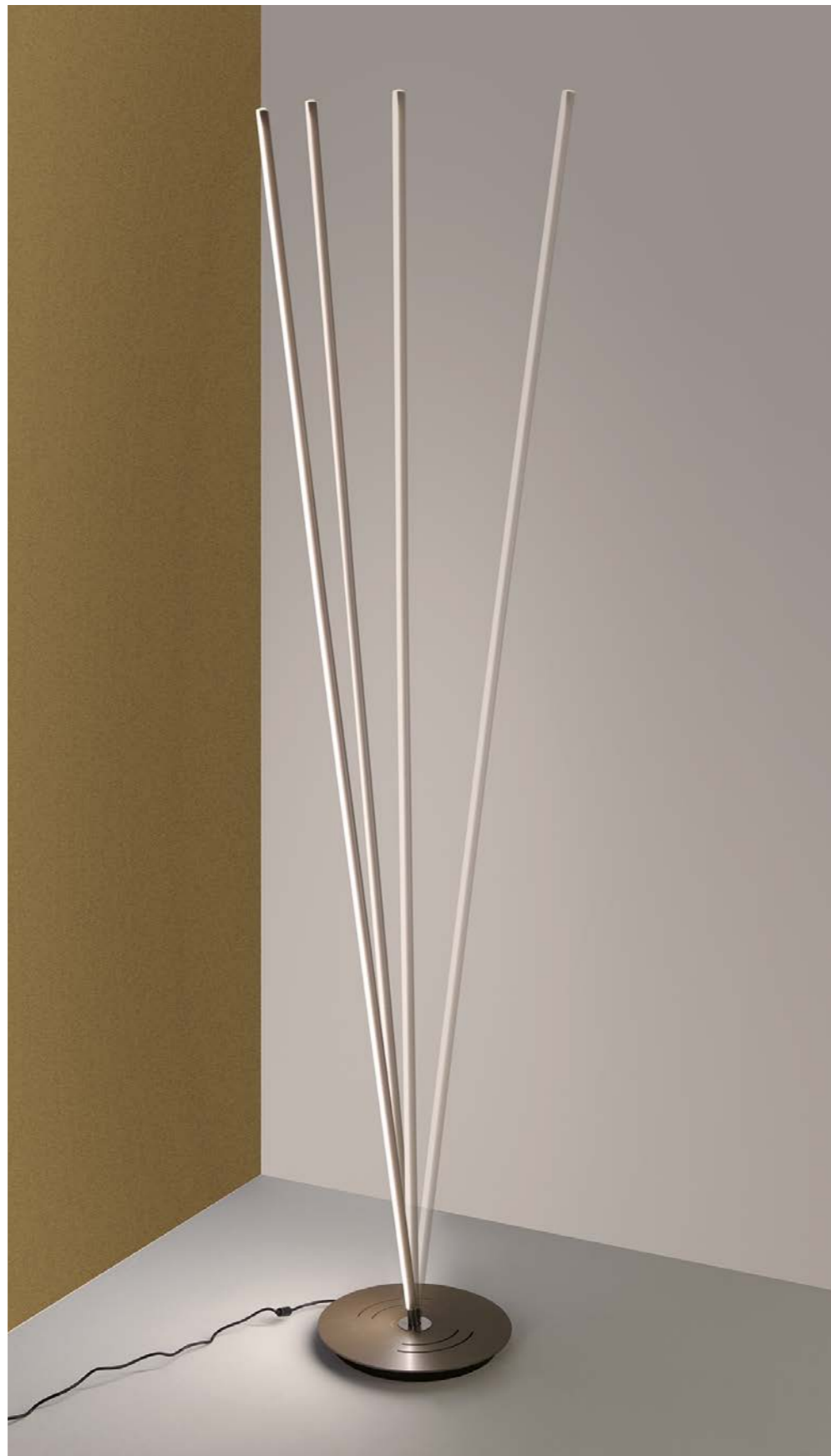

White

Black

Lacked Bronze

Sandy

Lacked Gold



905/200 T

LED 38W 24V Dc 220 - 240V
 4000lm 3000°K upon request 2700°/4000°K
 Net weight 3950gr - Gross weight 5300gr
 Volume m³ 0.06

CE IP20

2 boxes

Dimmable

remote control

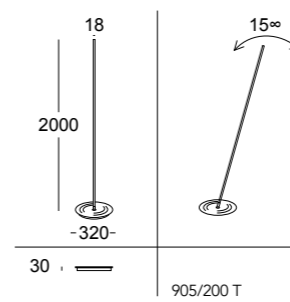

905/200 T



905/180 T

LED 34W 24V Dc 220 - 240V
 3600lm 3000°K upon request 2700°/4000°K
 Net weight 3800gr - Gross weight 5150gr
 Volume m³ 0.06

CE IP20

2 boxes

Dimmable

remote control

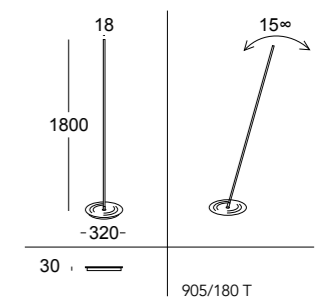

905/180 T

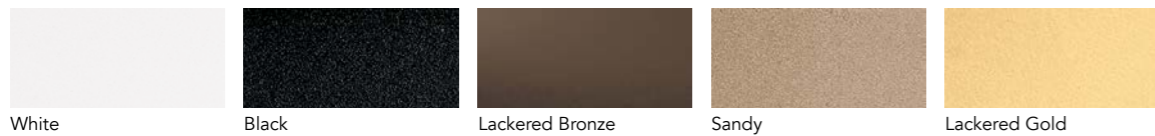

White

Black

Lackered Bronze

Sandy

Lackered Gold

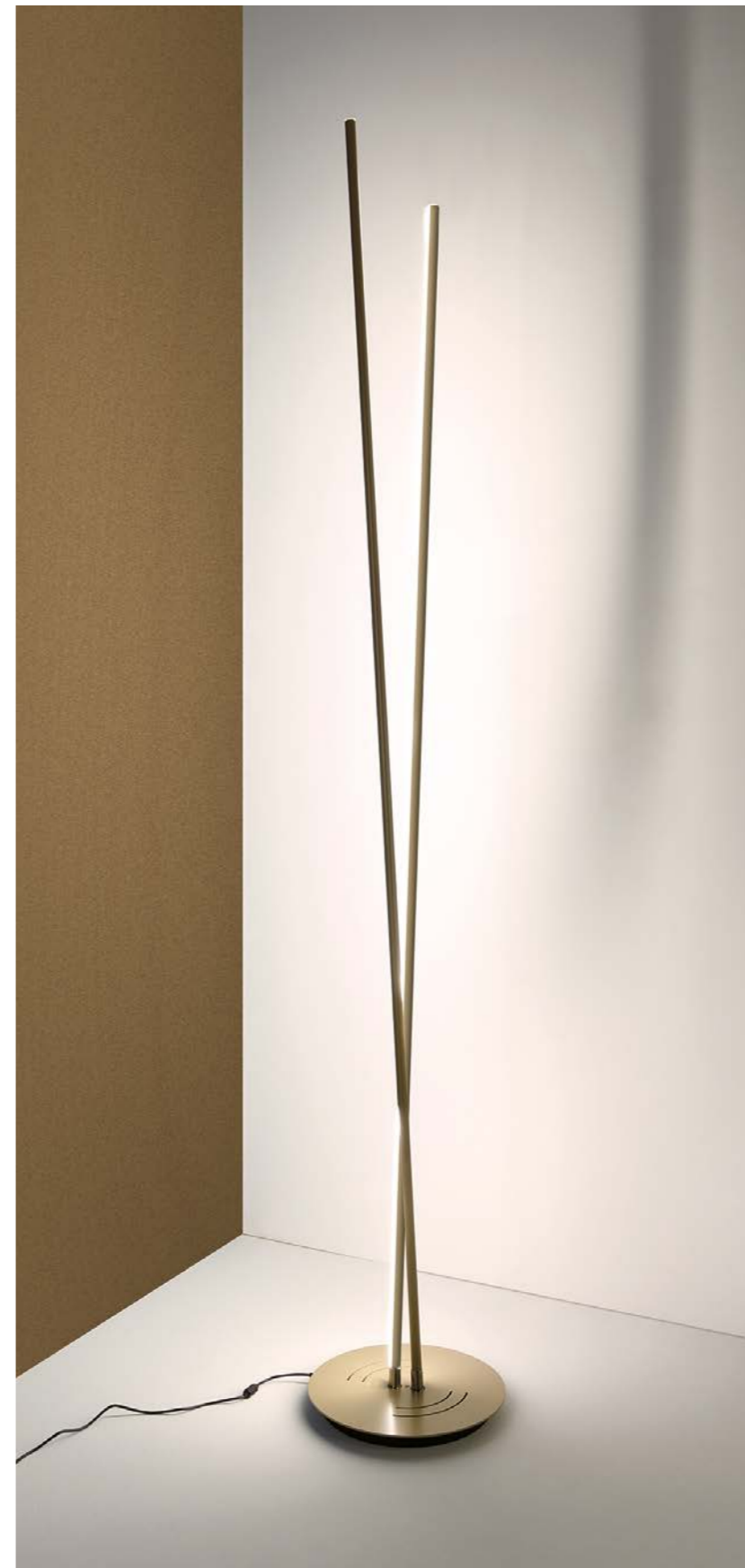

905/18.20 T

LED 72W 24V Dc 220 - 240V
 7600lm 3000°K upon request 2700°/4000°K
 Net weight 4400gr - Gross weight 5750gr
 Volume m³ 0.06

CE IP20

2 boxes

Dimmable

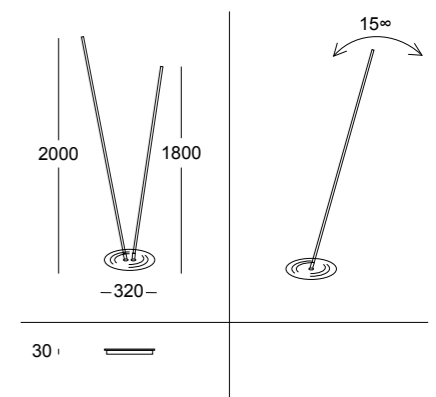

remote control

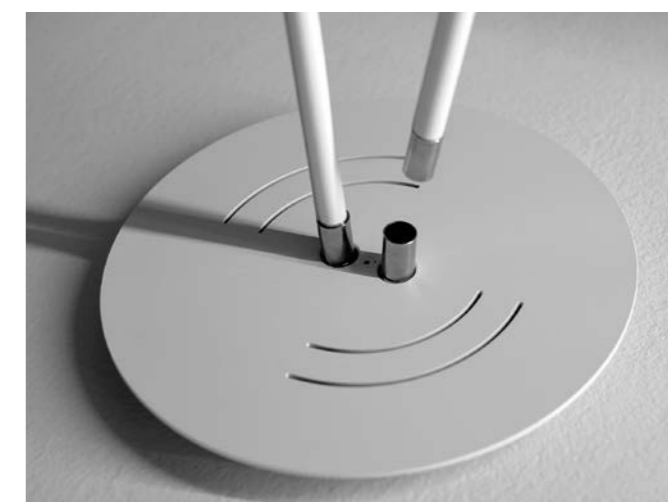
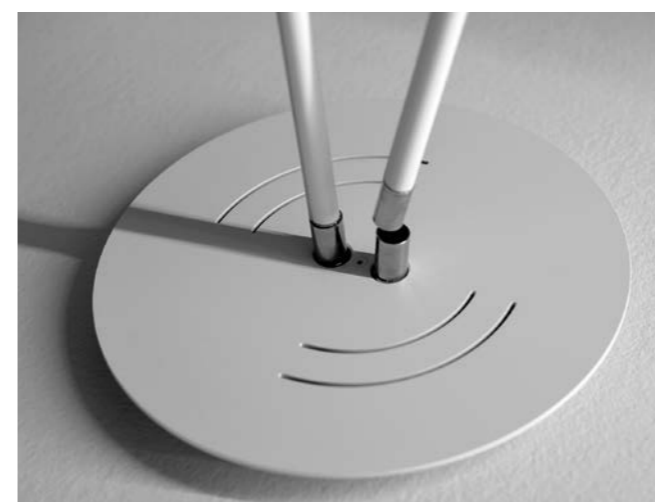
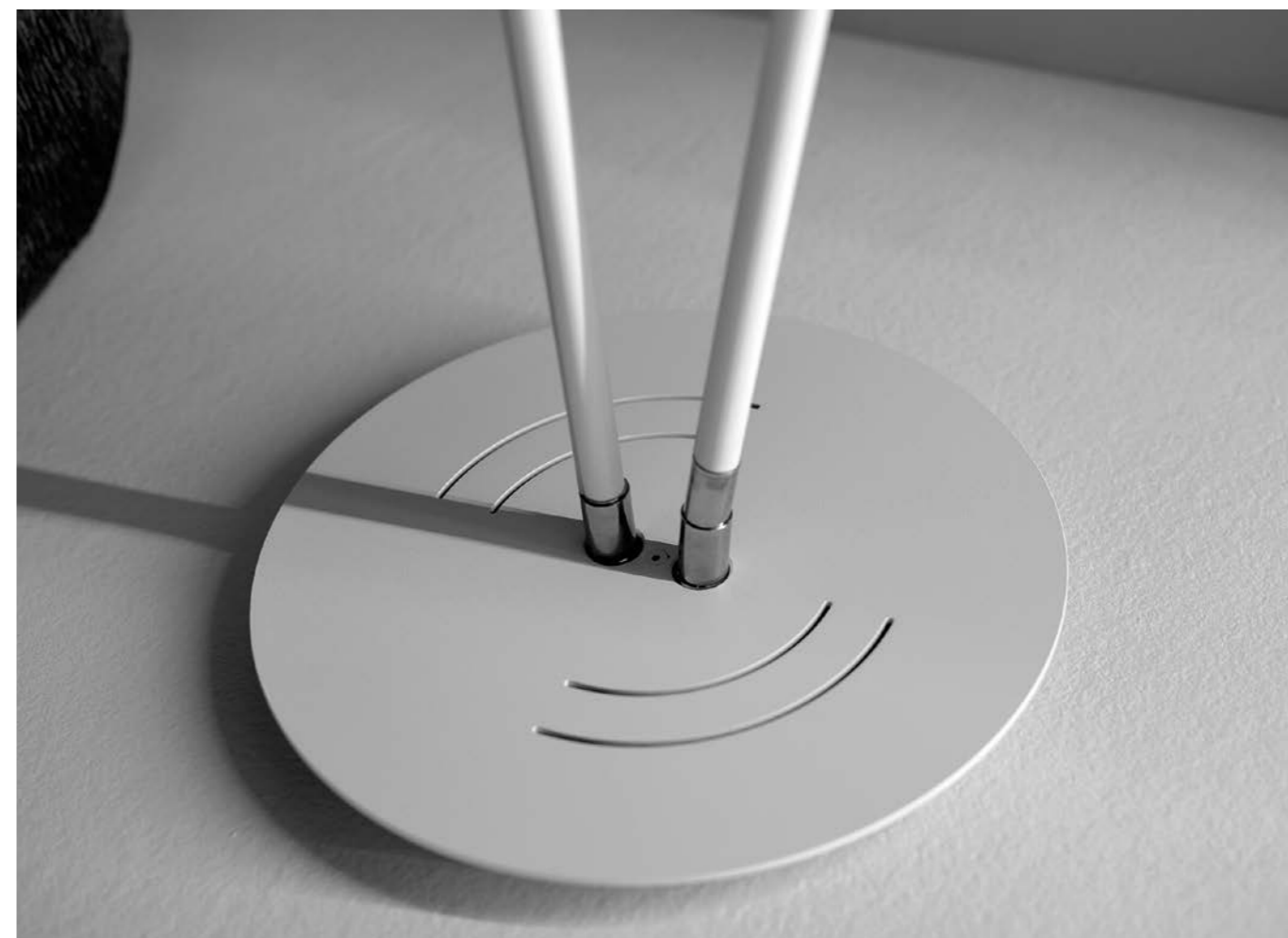

Montaggio facile con innesto jack che consente una rapida installazione.
Grazie alla sua versatilità si può inclinare, ruotare e creare scenari con luce diretta e/o indiretta.

*Easy mounting with a jack plug that allows for quick installation.
Thanks to its versatility, it can be tilted, rotated and create scenarios with direct and/or indirect light.*

*Einfache Montage mit einem Klinkenstecker, der eine schnelle Installation ermöglicht.
Wegen ihrer Vielseitigkeit kann sie gekippt und gedreht werden und Szenarien mit direktem
und/oder indirektem Licht schaffen.*

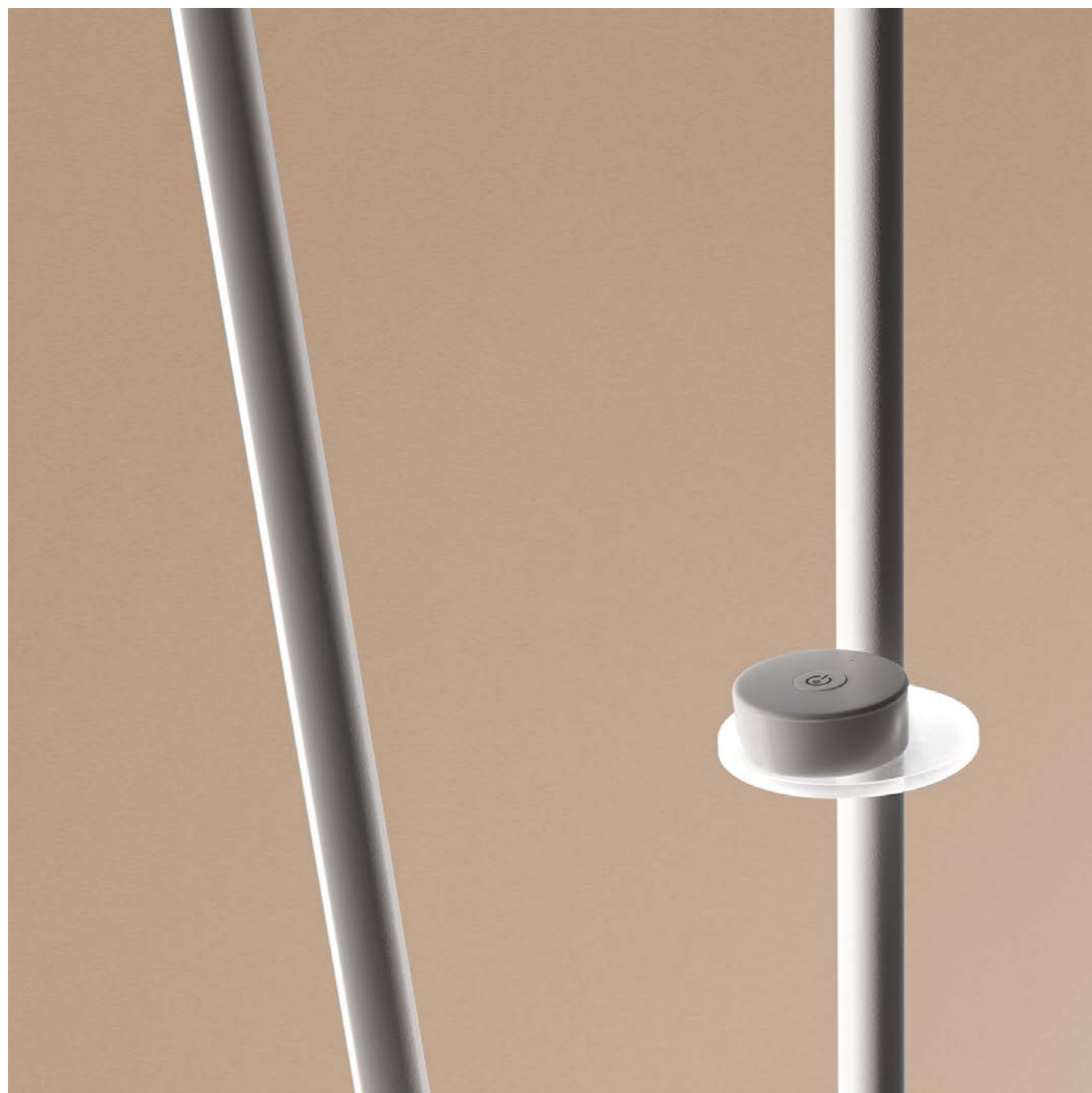

Lucilla è dimmerabile con il telecomando incluso, che si può tenere sulla lampada o staccare.

Lucilla is dimmable with the included remote control, which can be held on the lamp or removed.

Lucilla ist dimmbar mit der mitgelieferten Fernbedienung, die an der Leuchte befestigt oder abgenommen werden kann.

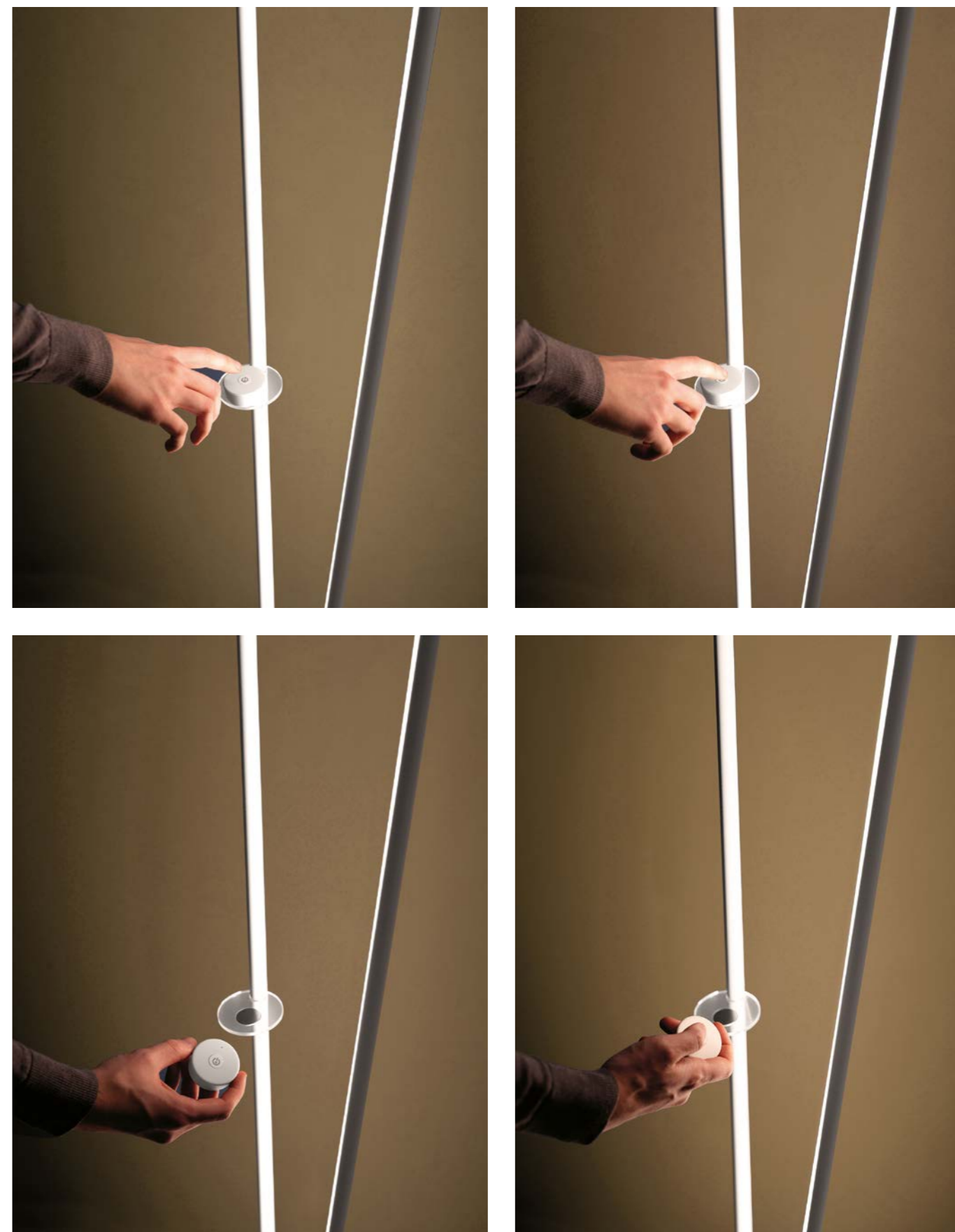

Lucilla suspension

design by C. Cattaneo

Una lampada versatile e dinamica, che nella sua leggerezza, permette semplicemente ruotandola di ottenere luce diretta o indiretta adeguandosi all'ambiente e alle esigenze illuminotecniche. Grazie alla sua linea minimal e alla varietà di colorazioni Lucilla si integra perfettamente sia in ambienti stile industrial, che in quelli più classici.

A versatile and dynamic lamp, which, in its lightness, allows simply by rotating it to obtain direct or indirect light, adapting to the environment and lighting requirements. Thanks to its minimal line and the variety of colours, Lucilla fits perfectly into both industrial and classic style environments.

Eine vielseitige und dynamische Leuchte, die es durch ihre Leichtigkeit ermöglicht, durch einfaches Drehen direktes oder indirektes Licht zu erhalten, das sich an die Umgebung und die Beleuchtungsanforderungen anpasst. Dank seiner minimalistischen Linie und der Farbvielfalt fügt sich Lucilla sowohl in industrielle als auch in klassische Umgebungen ein.





905/120 S

LED 23W 24V Dc 220 - 240V
2400lm 3000°K upon request 2700°/4000°K
Net weight 1150gr - Gross weight 1850gr
Volume m³ 0.036
CE IP20
Dimmable PHASE-CUT DIMMING

905/140 S

LED 27W 24V Dc 220 - 240V
2800lm 3000°K upon request 2700°/4000°K
Net weight 1200gr - Gross weight 1930gr
Volume m³ 0.040
CE IP20
Dimmable PHASE-CUT DIMMING

905/180 S

LED 34W 24V Dc 220 - 240V
3600lm 3000°K upon request 2700°/4000°K
Net weight 1250gr - Gross weight 1980gr
Volume m³ 0.053
CE IP20
Dimmable PHASE-CUT DIMMING

905/200 S

LED 38W 24V Dc 220 - 240V
4000lm 3000°K upon request 2700°/4000°K
Net weight 1370gr - Gross weight 2100gr
Volume m³ 0.053
CE IP20
Dimmable PHASE-CUT DIMMING

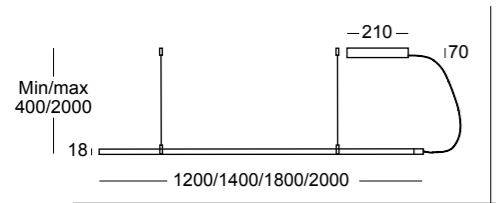

905/120 S
905/140 S
905/180 S
905/200 S

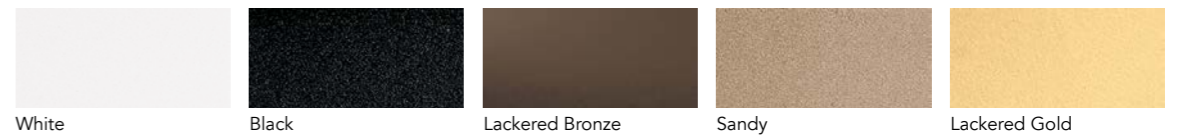

Lucilla wall, ceiling

design by C. Cattaneo

Lampada da parete e plafone, versatile a luce diretta e/o indiretta. Disponibile in diverse misure e colorazioni con 1 o 2 luci

Adjustable wall and ceiling lamp, versatile for direct and/or indirect light. Available in different sizes and colours with 1 or 2 lights.

Wandleuchte, vielseitig einsetzbar mit direktem und/oder indirektem Licht. Erhältlich in verschiedenen Größen und Farben mit 1 oder 2 Leuchten.



905/60 PA1

LED 12W 24V Dc 220 - 240V
1200lm 3000°K upon request 2700°/4000°K
Net weight 830gr - Gross weight 1300gr
Volume m³ 0.016
CE IP20

905/60 PA2

LED 24W 24V Dc 220 - 240V
2400lm 3000°K upon request 2700°/4000°K
Net weight 1660gr - Gross weight 2300gr
Volume m³ 0.020
CE IP20

905/80 PA1

LED 15W 24V Dc 220 - 240V
1500lm 3000°K upon request 2700°/4000°K
Net weight 880gr - Gross weight 1300gr
Volume m³ 0.026
CE IP20

905/80 PA2

LED 30W 24V Dc 220 - 240V
3000lm 3000°K upon request 2700°/4000°K
Net weight 1870gr - Gross weight 2470gr
Volume m³ 0.030
CE IP20

905/100 PA1

LED 20W 24V Dc 220 - 240V
2000lm 3000°K upon request 2700°/4000°K
Net weight 9000gr - Gross weight 1300gr
Volume m³ 0.026
CE IP20

905/100 PA2

LED 40W 24V Dc 220 - 240V
4000lm 3000°K upon request 2700°/4000°K
Net weight 1870gr - Gross weight 2560gr
Volume m³ 0.030
CE IP20

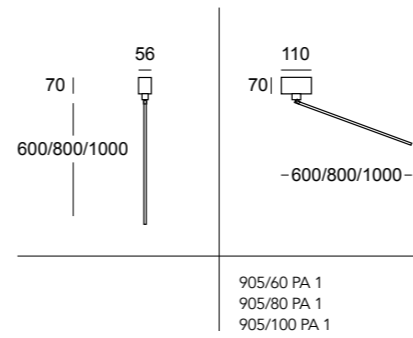

905/60 PA 1
905/80 PA 1
905/100 PA 1

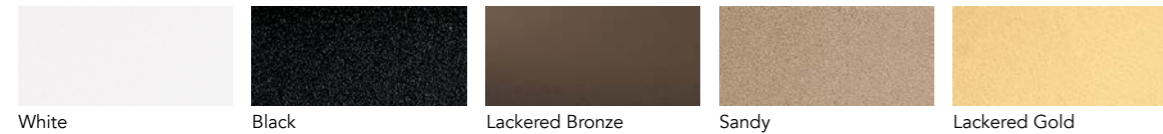



905/60.80 PA2

LED 28W 24V Dc 220 - 240V
2800lm 3000°K upon request 2700°/4000°K
Net weight 1720gr - Gross weight 2320gr
Volume m³ 0.030
CE IP20

905/60.100 PA2

LED 32W 24V Dc 220 - 240V
3200lm 3000°K upon request 2700°/4000°K
Net weight 1770gr - Gross weight 2470gr
Volume m³ 0.030
CE IP20

905/80.100 PA2

LED 36W 24V Dc 220 - 240V
3600lm 3000°K upon request 2700°/4000°K
Net weight 1820gr - Gross weight 2510gr
Volume m³ 0.030
CE IP20

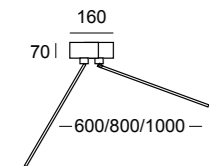
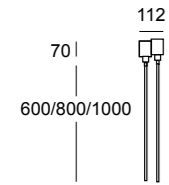

905/60.80 PA2
905/60.100 PA2
905/80.100 PA2

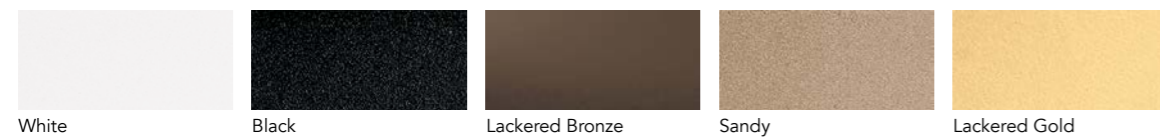





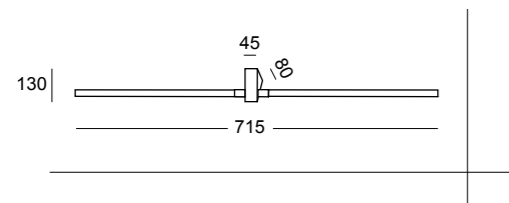

915/60 PA2

LED 12W 24V Dc 220 - 240V
 1200lm 3000°K upon request 2700°/4000°K
 Net weight 900gr - Gross weight 1900gr
 Volume m³ 0.030
 CE IP20

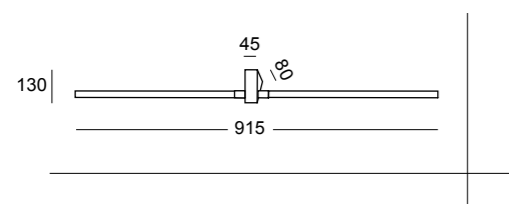

915/80 PA2

LED 16W 24V Dc 220 - 240V
 1600lm 3000°K upon request 2700°/4000°K
 Net weight 950gr - Gross weight 1950gr
 Volume m³ 0.030
 CE IP20

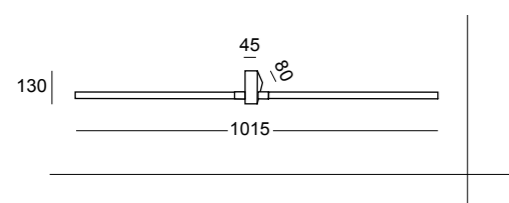

915/100 PA2

LED 20W 24V Dc 220 - 240V
 2000lm 3000°K upon request 2700°/4000°K
 Net weight 1000gr - Gross weight 2000gr
 Volume m³ 0.030
 CE IP20

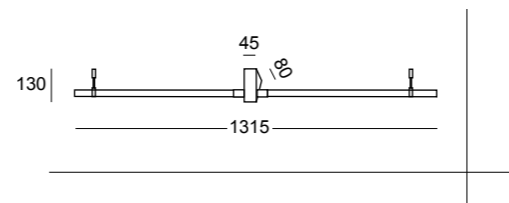

915/120 PA2

LED 24W 24V Dc 220 - 240V
 2400lm 3000°K upon request 2700°/4000°K
 Net weight 1030gr - Gross weight 2150gr
 Volume m³ 0.030
 CE IP20

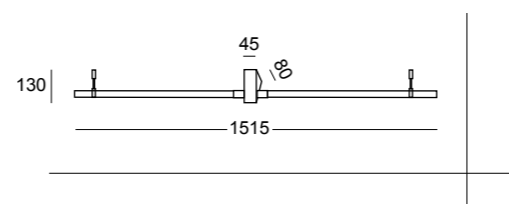

915/140 PA2

LED 28W 24V Dc 220 - 240V
 2800lm 3000°K upon request 2700°/4000°K
 Net weight 1100gr - Gross weight 2320gr
 Volume m³ 0.030
 CE IP20

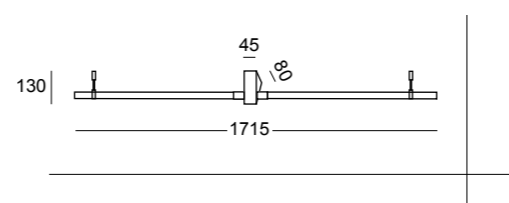

915/160 PA2

LED 32W 24V Dc 220 - 240V
 3200lm 3000°K upon request 2700°/4000°K
 Net weight 1150gr - Gross weight 2370gr
 Volume m³ 0.030
 CE IP20

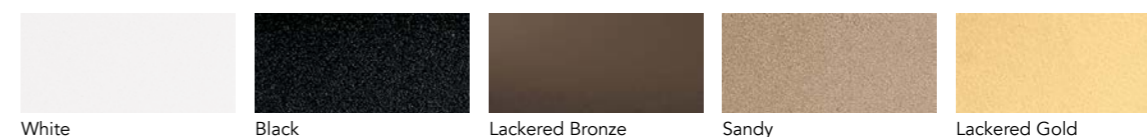
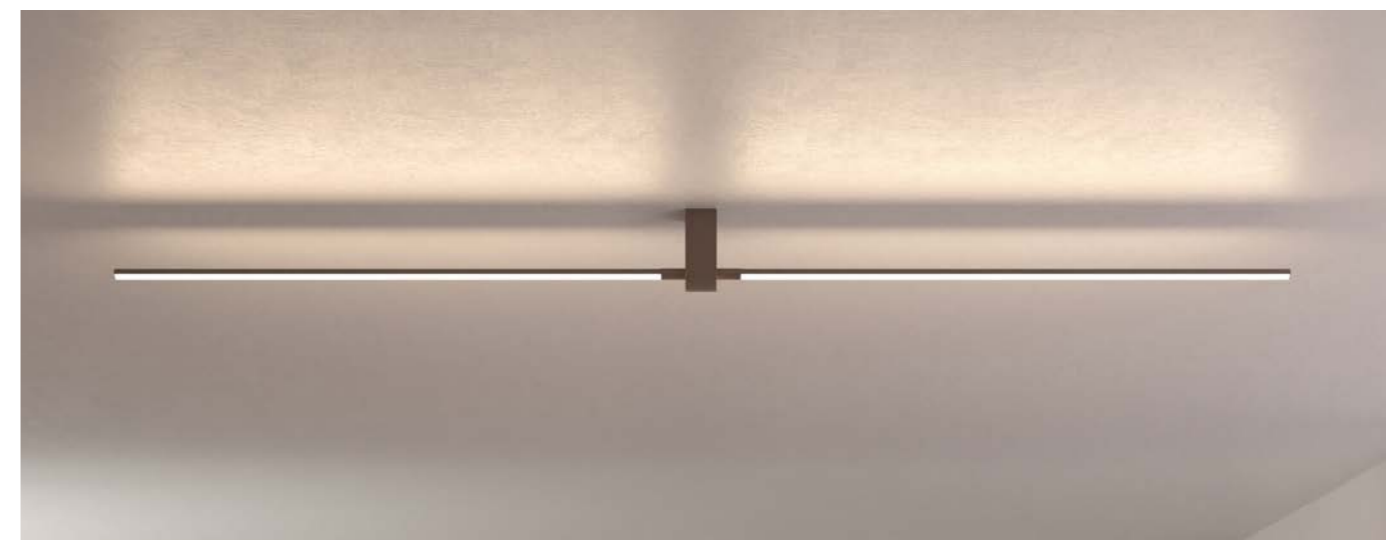

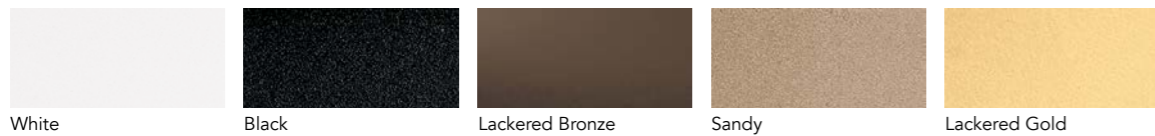

White

Black

Lackered Bronze

Sandy

Lackered Gold

915/160 TP

LED 32W 24V Dc 220 - 240V
 3200lm 3000°K upon request 2700°/4000°K
 Net weight 1155gr - Gross weight 2038gr
 Volume m³ 0.014

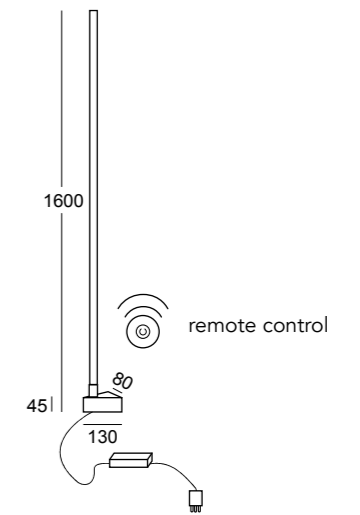

915/180 TP

LED 36W 24V Dc 220 - 240V
 3600lm 3000°K upon request 2700°/4000°K
 Net weight 1235gr - Gross weight 2118gr
 Volume m³ 0.014

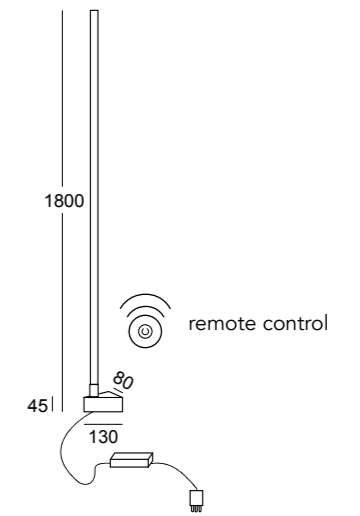

915/200 TP

LED 40W 24V Dc 220 - 240V
 4000lm 3000°K upon request 2700°/4000°K
 Net weight 1315gr - Gross weight 2198gr
 Volume m³ 0.014

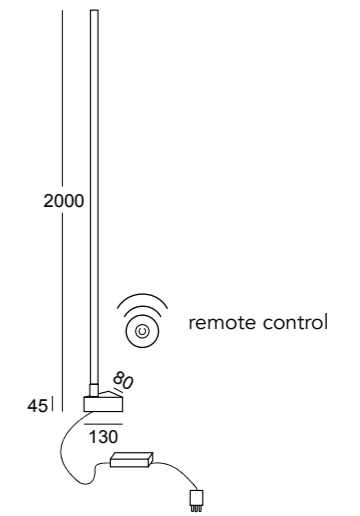

Easy System

design by C. Cattaneo

Sistema a sospensione personalizzabile.
Grazie alla sua struttura il sistema Easy System
ti permette di raggiungere luoghi d'illuminazione
lontani dal tuo punto luce creando piacevoli
installazioni.

*Suspended system that can be customised.
Thanks to its peculiar structure, Easy System makes
it possible to bring light away from light sources,
creating nice installations.*

*Flexibles System von Hängelampen, das einfach
an persönliche Bedürfnisse angepasst werden kann.
Die Struktur des Easy System bietet die Möglichkeit,
das Licht weit weg vom Stromverteiler zu tragen und
faszinierende Installationsformen zu kreieren.*



Drop

design by C. Cattaneo

Sospensione in alluminio tornito dalla classica forma di una goccia verniciato nelle colorazioni bianco, sabbia, nero, grigio e nei nuovi colori oro, bronzo, argento e ardesia, fornita di un led da 8w 900 lumen dotata internamente di un rocchetto per il recupero del cavo in eccesso (fino a 2 metri) e con collegamento tramite jack per un veloce e sicuro collegamento alla sua base con alimentatore.

Suspension lamp in turned aluminium in the classic drop shape painted in white, sand, black, grey and in the new colours gold, bronze, silver and slate, equipped with an 8W 900 lumen LED with an internal reel for recovering the excess cable (up to 2 metres) and with a jack connection for a fast and safe connection to its base with power supply.

Hängeleuchte aus gedrehtem Aluminium in klassischer Tropfenform, lackiert in den Farben Weiß, Sand, Schwarz, Grau und in den neuen Farben Gold, Bronze, Silber und Schiefer, ausgestattet mit einer 8W LED mit 900 Lumen, mit interner Kabelaufwicklung für die Rückgewinnung des überschüssigen Kabels (bis zu 2 Meter) und mit einem Klinkenanschluss für eine schnelle und sichere Verbindung zum Sockel mit Stromversorgung.



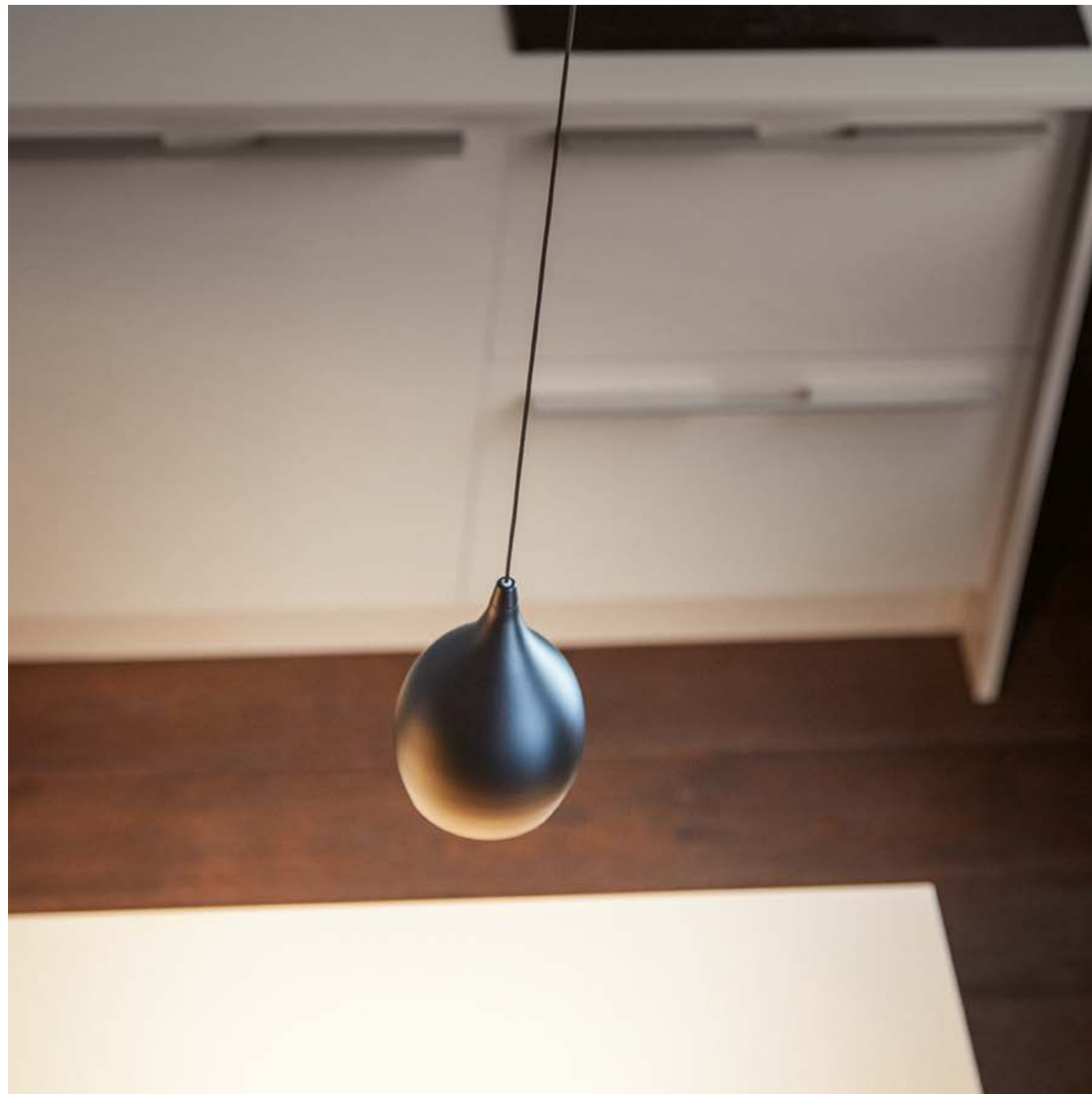

Module
786/13 S 2m / 3m / 5m / 7m / 10m
 LED 8W 700mA CC 900lm 3000°K
 upon request 2700°/4000° K
 Net weight 370gr - Gross weight 750gr
 Volume m³ 0,0084
 push or dali dimming

CE  IP20

Standard colours

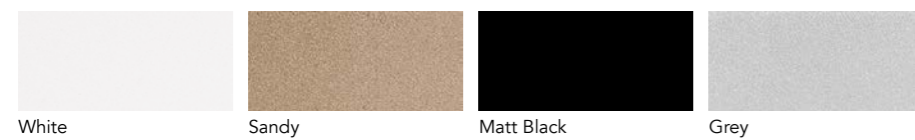

White Sandy Matt Black Grey

Module to be completed with
 one of the bases on page 460

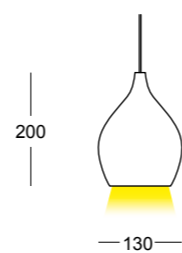

Module
787/13 S 2m / 3m / 5m / 7m / 10m
 LED 8W 700mA CC 900lm 3000°K
 upon request 2700°/4000° K
 Net weight 370gr - Gross weight 750gr
 Volume m³ 0,0084
 push or dali dimming

CE  IP20

Special colours

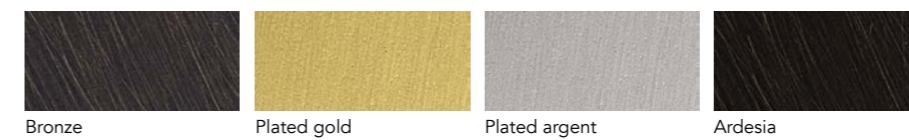

Bronze Plated gold Plated argent Ardesia

Module to be completed with
 one of the bases on page 460

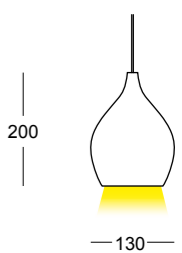





Mini Soft

design by C. Cattaneo

Sospensione in alluminio tornito verniciato nelle colorazioni bianco, sabbia, nero, grigio e nei nuovi colori oro, bronzo, argento e ardesia, fornita di un led da 8w 900 lumen dotata internamente di un rocchetto per il recupero del cavo in eccesso (fino a 2 metri) e con collegamento tramite jack per un veloce e sicuro collegamento alla sua base con alimentatore.

Suspension in turned aluminium painted in white, sand, black, grey and in the new colours gold, bronze, silver and slate, equipped with an 8w 900 lumen LED with an internal reel for recovering the excess cable (up to 2 metres) and with a jack connection for a fast and safe connection to its base with power supply.

Aufhängung aus gedrehtem Aluminium, lackiert in den Farben Weiß, Sand, Schwarz, Grau und in den neuen Farben Gold, Bronze, Silber und Schiefer, ausgestattet mit einer 8W 900 Lumen LED mit interner Kabelaufwicklung für die Rückgewinnung des überschüssigen Kabels (bis zu 2 Meter) und mit einem Klinkenanschluss für einen schnellen und sicheren Anschluss an die Basis mit Stromversorgung.





Module

785/16 S 2m / 3m / 5m / 7m / 10m

LED 8W 700mA CC 900lm 3000°K

upon request 2700°/4000° K

Net weight 320gr - Gross weight 730gr

Volume m³ 0,0084

 push or dali dimming

CE  IP20

Standard colours



White

Sandy

Matt Black

Grey

Module to be completed with one of the bases on page 460

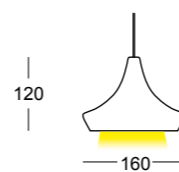

Module

788/16 S 2m / 3m / 5m / 7m / 10m

LED 8W 700mA CC 900lm 3000°K

upon request 2700°/4000° K

Net weight 320gr - Gross weight 730gr

Volume m³ 0,0084

 push or dali dimming

CE  IP20

Special colours



Bronze

Plated gold

Plated argent

Ardesia

Module to be completed with one of the bases on page 460

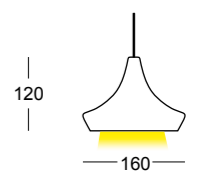







Time

design by C. Cattaneo

Sospensione in alluminio tornito verniciato nelle colorazioni bianco, sabbia, nero, grigio e nei nuovi colori oro, bronzo, argento e ardesia, fornita di un led da 8w 900 lumen dotata internamente di un rocchetto per il recupero del cavo in eccesso (fino a 2 metri) e con collegamento tramite jack per un veloce e sicuro collegamento alla sua base con alimentatore.

Suspension in turned aluminium painted in white, sand, black, grey and in the new colours gold, bronze, silver and slate, equipped with an 8w 900 lumen LED with an internal reel for recovering the excess cable (up to 2 metres) and with a jack connection for a fast and safe connection to its base with power supply.

Aufhängung aus gedrehtem Aluminium, lackiert in den Farben Weiß, Sand, Schwarz, Grau und in den neuen Farben Gold, Bronze, Silber und Schiefer, ausgestattet mit einer 8W 900 Lumen LED mit interner Kabelaufwicklung für die Rückgewinnung des überschüssigen Kabels (bis zu 2 Meter) und mit einem Klinkenanschluss für einen schnellen und sicheren Anschluss an die Basis mit Stromversorgung.





Module

783/11S 2m / 3m / 5m / 7m / 10m

LED 8W 700mA CC 900lm 3000°K

upon request 2700°/4000° K

Net weight 370gr - Gross weight 680gr

Volume m³ 0,0069

 push or dali dimming

CE  IP20

Standard colours



White

Sandy

Matt Black

Grey

Module to be completed with one of the bases on page 460



Module

789/11S 2m / 3m / 5m / 7m / 10m

LED 8W 700mA CC 900lm 3000°K

upon request 2700°/4000° K

Net weight 370gr - Gross weight 680gr

Volume m³ 0,0069

 push or dali dimming

CE  IP20

Special colours



Bronze

Plated gold

Plated argent

Ardesia

Module to be completed with one of the bases on page 460



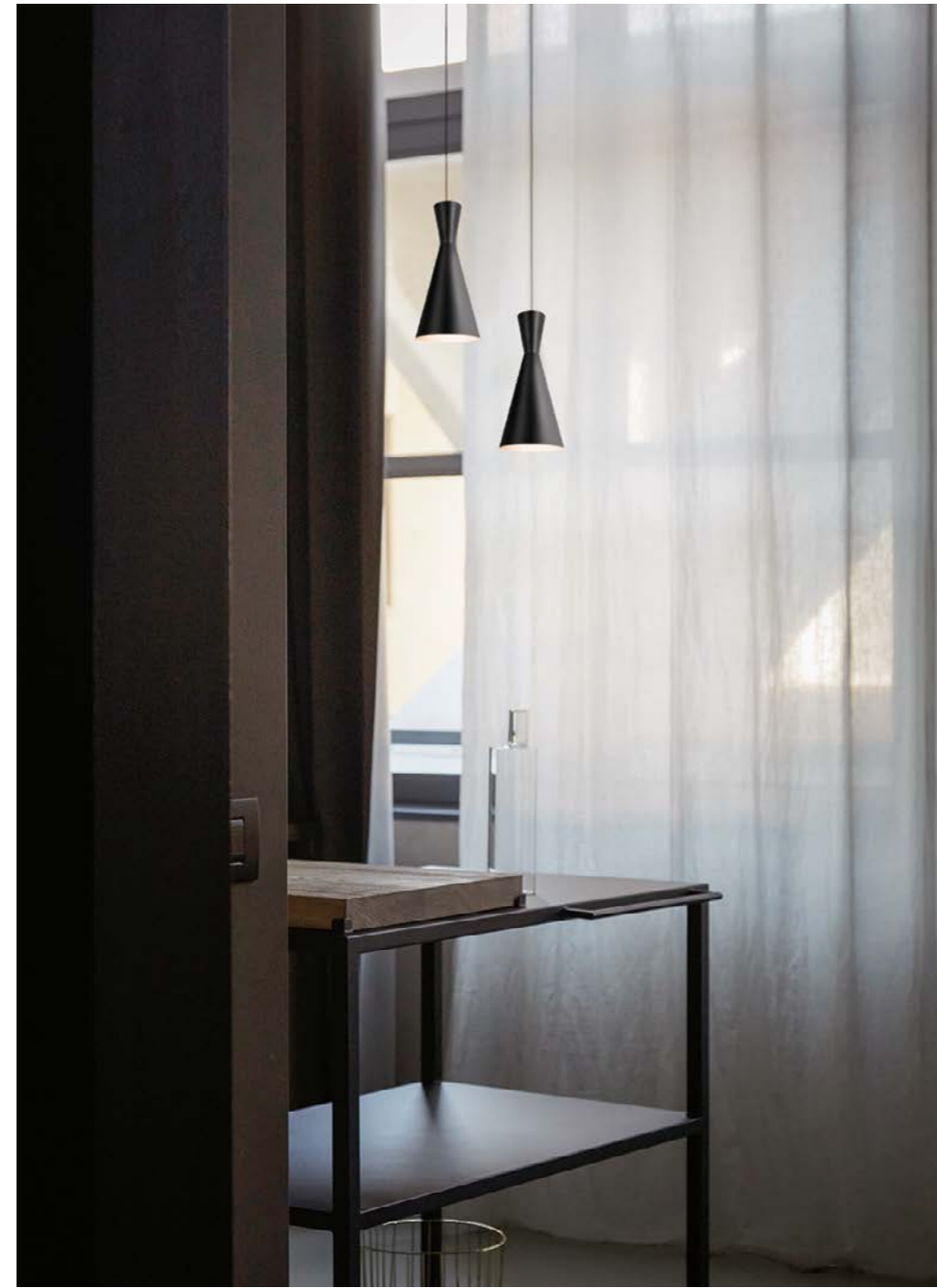
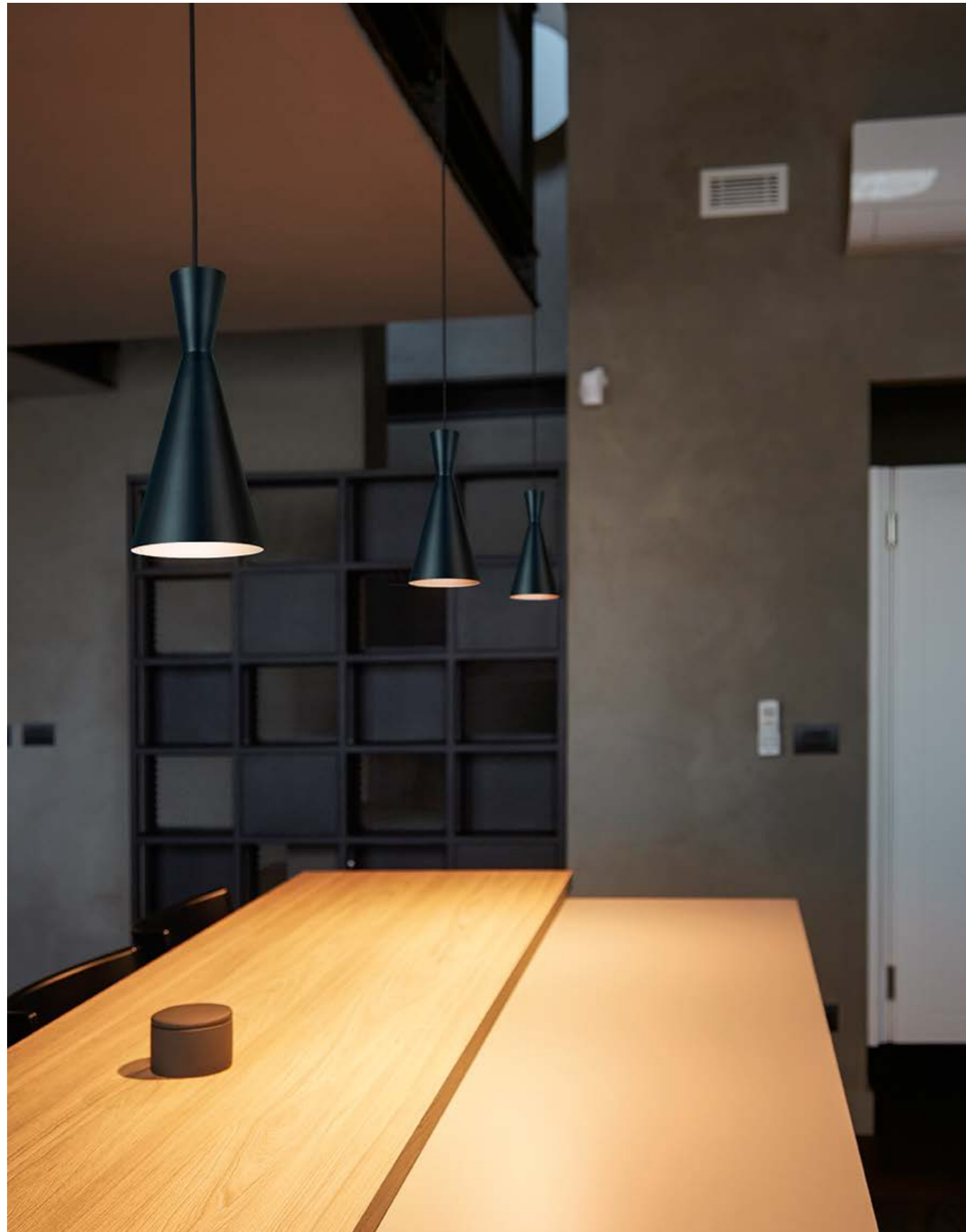

Mini Mercury

design by C. Cattaneo

Sospensione in vetro soffiato in color biancolatte fornita di un led da 8w 900 lumen dotata internamente di un rocchetto per il recupero del cavo in eccesso (fino a 2 metri) e con collegamento tramite jack per un veloce e sicuro collegamento alla sua base con alimentatore.

Suspension with blown glass diffuser in milky-white color, equipped with an 8w 900 lumens led internally equipped with a spool for the recovery of excess cable (up to 2 metres) and with connection via jack for a fast and secure connection to its power supply.

Aufhängung aus geblasenem Glas in milchweißer Farbe, ausgestattet mit einer LED von 8W 900 Lumen, die intern mit einer Spule zur Rückgewinnung von überschüssigem Kabel (bis zu 2 Meter) und mit Anschluss über Buchse für eine schnelle und sichere Verbindung mit dem Sockel mit Stromversorgung ausgestattet ist.





Module

784/16 S 2m / 3m / 5m / 7m / 10m

LED 8W 700mA CC 900lm 3000°K

upon request 2700°/4000° K

Net weight 710gr - Gross weight 1070gr

Volume m³ 0,0084

 push or dali dimming

CE  IP20

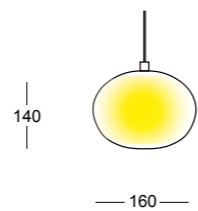

Module to be completed with
one of the bases on page 460

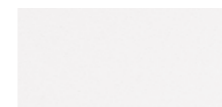

White



Stretch

design by C. Cattaneo

Sospensione in alluminio verniciato nelle colorazioni bianco, sabbia, nero, grigio e nei nuovi colori oro, bronzo, argento e ardesia, fornita di un led da 8w 900 lumen dotata internamente di un rocchetto per il recupero del cavo in eccesso (fino a 2 metri) e con collegamento tramite jack per un veloce e sicuro collegamento alla sua base con alimentatore.

Suspension lamp in painted aluminium in white, sand, black, grey and the new colours gold, bronze, silver and slate, equipped with an 8W 900 lumen LED, internally equipped with a reel for recovering the excess cable (up to 2 metres) and with a jack connection for a fast and safe connection to its base with power supply.

Hängeleuchte aus lackiertem Aluminium in den Farben Weiß, Sand, Schwarz, Grau und den neuen Farben Gold, Bronze, Silber und Schiefer, ausgestattet mit einer 8W-LED mit 900 Lumen, intern ausgestattet mit einer Rolle für die Rückgewinnung des überschüssigen Kabels (bis zu 2 Meter) und mit einem Klinkenanschluss für eine schnelle und sichere Verbindung zur Basis mit Stromversorgung.

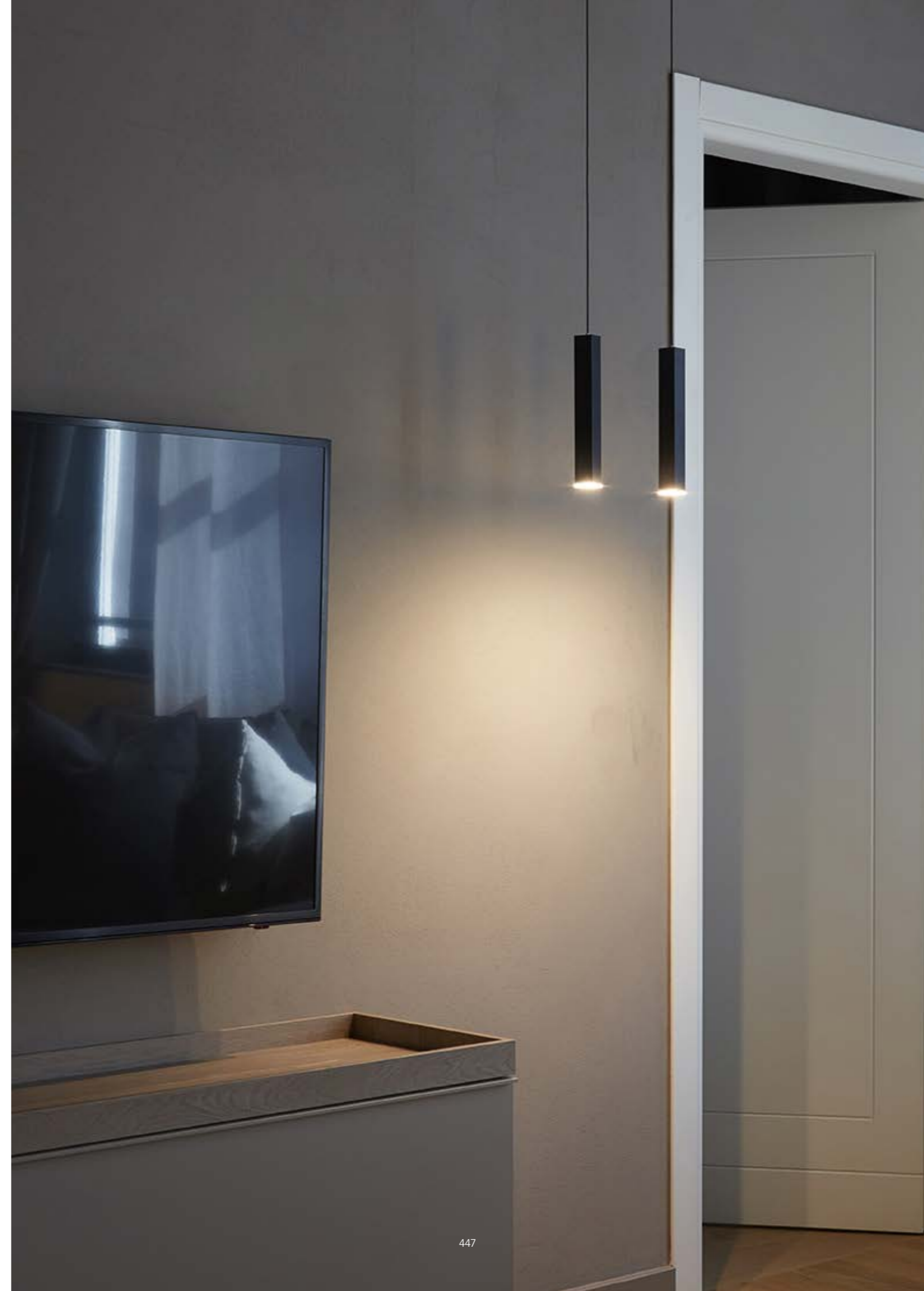

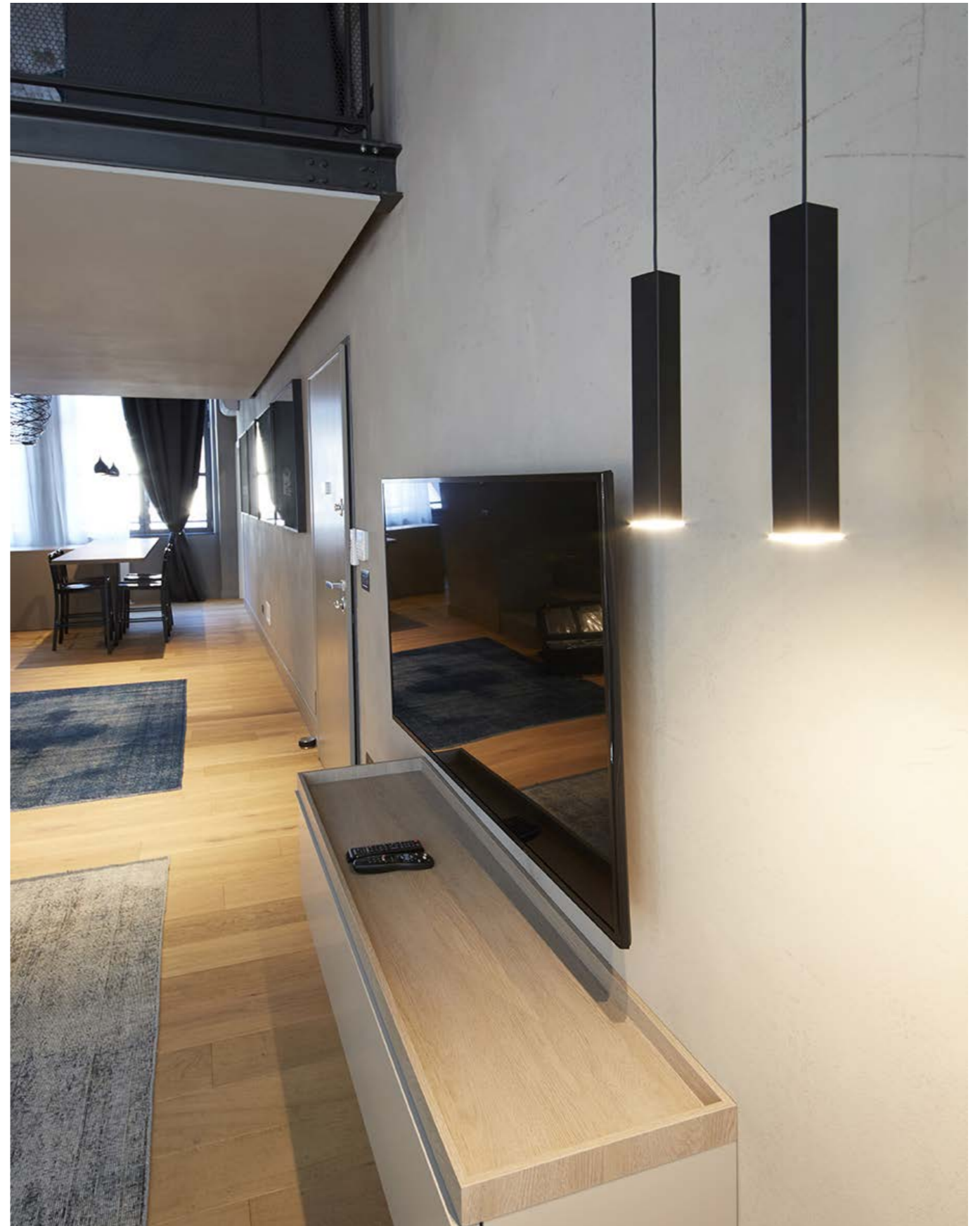

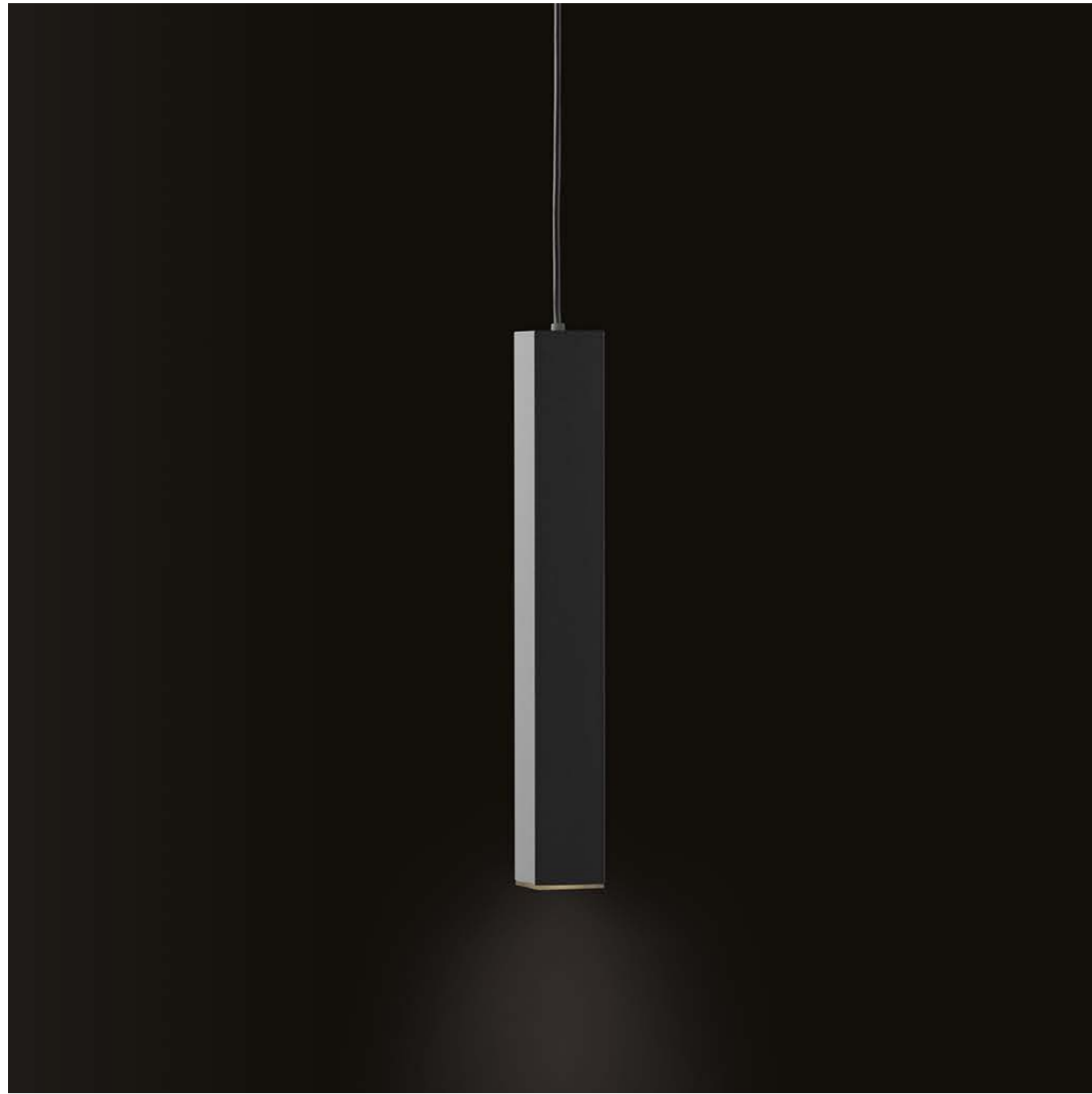

Module
776/1 S 2m / 3m / 5m / 7m / 10m
 LED 8W 700mA CC 900lm 3000°K
 upon request 2700°/4000° K
 Net weight 340gr - Gross weight 470gr
 Volume m³ 0,0010
 push or dali dimming

CE  IP20

Standard colours

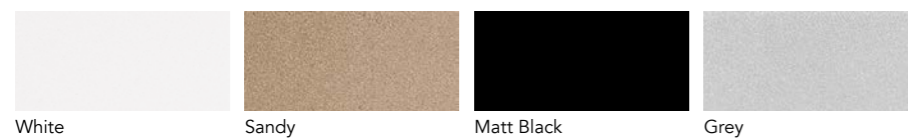

White Sandy Matt Black Grey

Module to be completed with one of the bases on page 460

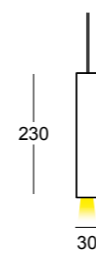

Module
769/1 S 2m / 3m / 5m / 7m / 10m
 LED 8W 700mA CC 900lm 3000°K
 upon request 2700°/4000° K
 Net weight 340gr - Gross weight 470gr
 Volume m³ 0,0010
 push or dali dimming

CE  IP20

Special colours

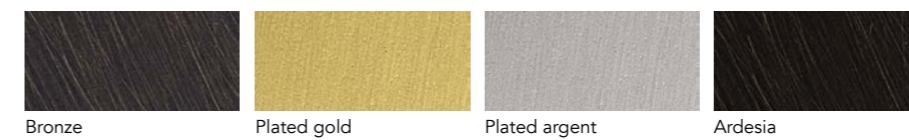

Bronze Plated gold Plated argent Ardesia

Module to be completed with one of the bases on page 460

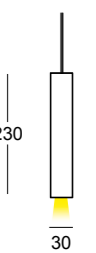

E.R.

design by C Cattaneo

Sospensione in alluminio verniciato nelle colorazioni bianco, sabbia, nero, grigio e nei nuovi colori oro, bronzo, argento e ardesia, fornita di un led da 8w 900 lumen dotata internamente di un rocchetto per il recupero del cavo in eccesso (fino a 2 metri) e con collegamento tramite jack per un veloce e sicuro collegamento alla sua base con alimentatore.

Suspension lamp in painted aluminium in white, sand, black, grey and the new colours gold, bronze, silver and slate, equipped with an 8W 900 lumen LED, internally equipped with a reel for recovering the excess cable (up to 2 metres) and with a jack connection for a fast and safe connection to its base with power supply.

Hängeleuchte aus lackiertem Aluminium in den Farben Weiß, Sand, Schwarz, Grau und den neuen Farben Gold, Bronze, Silber und Schiefer, ausgestattet mit einer 8W-LED mit 900 Lumen, intern ausgestattet mit einer Rolle für die Rückgewinnung des überschüssigen Kabels (bis zu 2 Meter) und mit einem Klinkenanschluss für eine schnelle und sichere Verbindung zur Basis mit Stromversorgung.



Module

848/30S 2m/3m/5m/7m/10m

LED 8W 700mA CC 900lm 3000°K

upon request 2700°/4000°K

Net weight 265gr - Gross weight 480gr

Volume m³ 0,009

 push or dali dimming

CE  IP20



Module

848/45S 2m/3m/5m/7m/10m

LED 8W 700mA CC 900lm 3000°K

upon request 2700°/4000°K

Net weight 265gr - Gross weight 480gr

Volume m³ 0,009

 push or dali dimming

CE  IP20

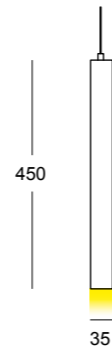

Module

847/30S 2m/3m/5m/7m/10m

LED 8W 700mA CC 900lm 3000°K

upon request 2700°/4000°K

Net weight 265gr - Gross weight 480gr

Volume m³ 0,009

 push or dali dimming

CE  IP20



Module

847/45S 2m/3m/5m/7m/10m

LED 8W 700mA CC 900lm 3000°K

upon request 2700°/4000°K

Net weight 265gr - Gross weight 480gr

Volume m³ 0,009

 push or dali dimming

CE  IP20

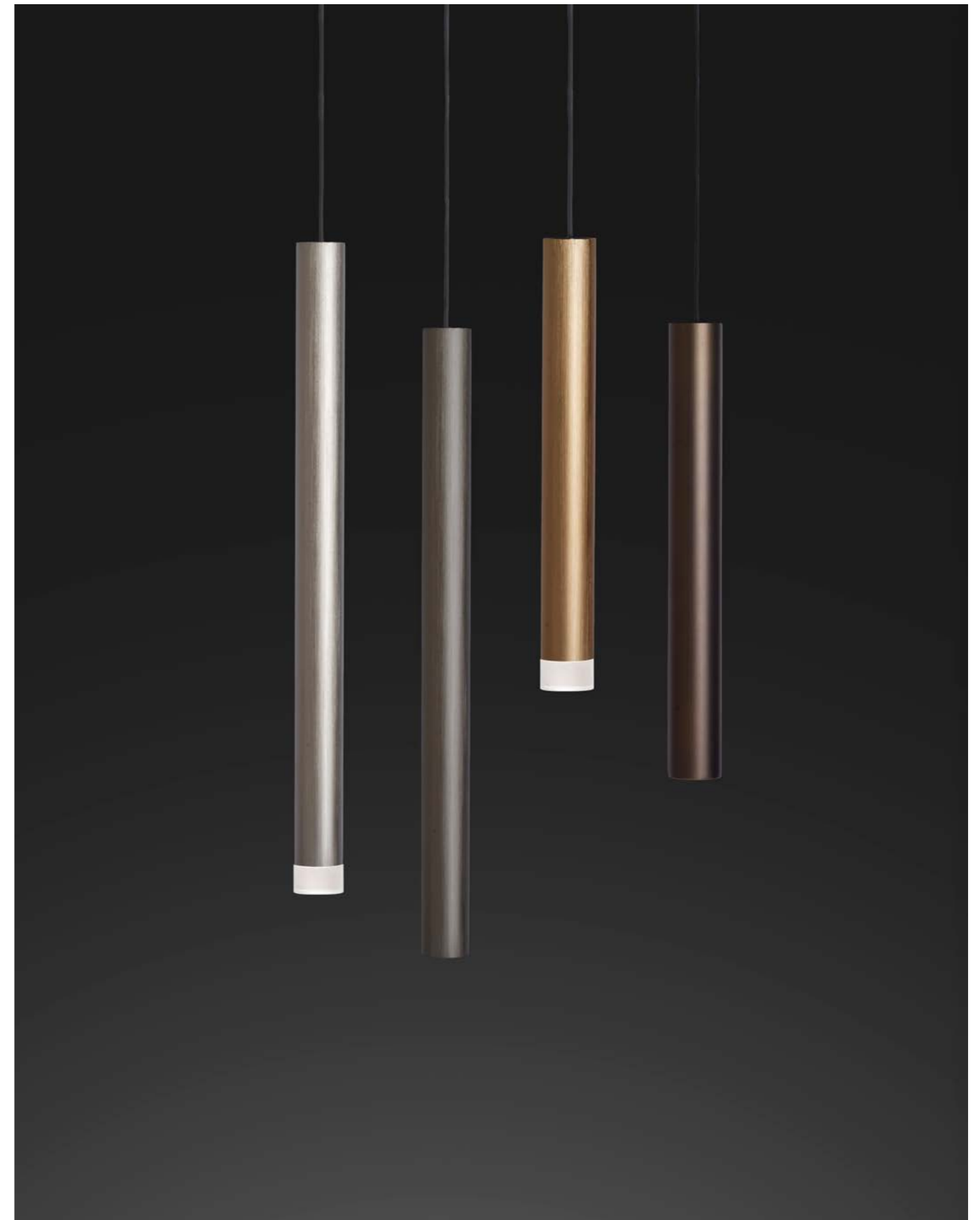
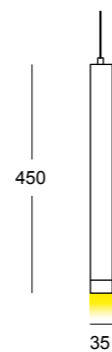

Special colours

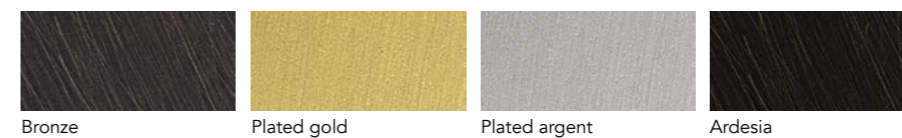

Module to be completed with one of the bases on page 460



Module

849/30S 2m/3m/5m/7m/10m

LED 8W 700mA CC 900lm 3000°K

upon request 2700°/4000°K

Net weight 265gr - Gross weight 480gr

Volume m³ 0,009

 push or dali dimming

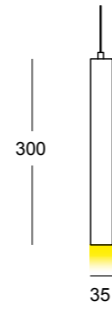

Module

849/45S 2m/3m/5m/7m/10m

LED 8W 700mA CC 900lm 3000°K

upon request 2700°/4000°K

Net weight 265gr - Gross weight 480gr

Volume m³ 0,009

 push or dali dimming

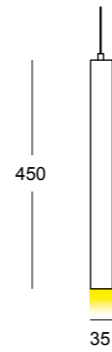

Module

850/30S 2m/3m/5m/7m/10m

LED 8W 700mA CC 900lm 3000°K

upon request 2700°/4000°K

Net weight 265gr - Gross weight 480gr

Volume m³ 0,009

 push or dali dimming

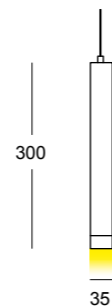

Module

850/45S 2m/3m/5m/7m/10m

LED 8W 700mA CC 900lm 3000°K

upon request 2700°/4000°K

Net weight 265gr - Gross weight 480gr

Volume m³ 0,009

 push or dali dimming

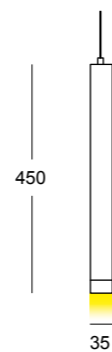

Standard colours



Module to be completed with one of the bases on page 460

Base for 1 module

776/1 R

Net weight 330gr
Gross weight 480g
Volume m³ 0.0046

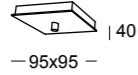

Up to 1 modules



Bases with side exits

776/16 R

Net weight 910gr
Gross weight 1070gr
Volume m³ 0.0024

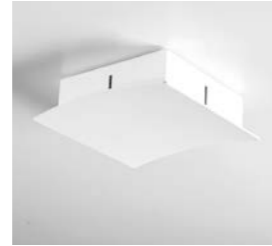

2 to 4 modules

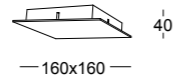

776/20 R

Net weight 1310gr
Gross weight 1850gr
Volume m³ 0.0024

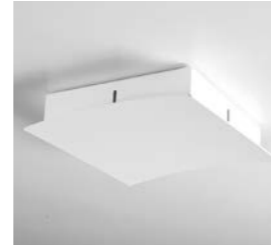

5 to 8 modules

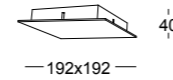

Concealed spool for recovery of excess cable

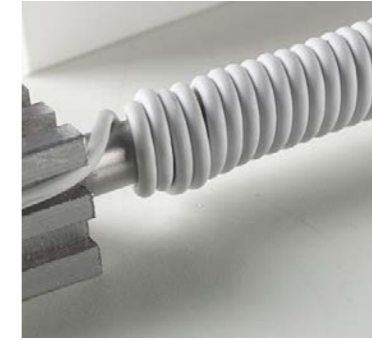

Cable Holder

776/1RC

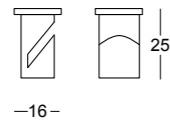
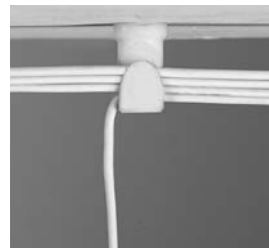

Bases with side and central descent

776/16TC

Net weight 910gr
Gross weight 1070gr
Volume m³ 0.0024



2 to 4 modules

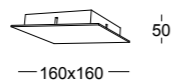

776/20TC

Net weight 1310gr
Gross weight 1850gr
Volume m³ 0.0024

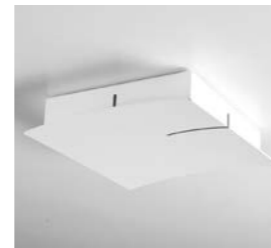

5 to 8 modules

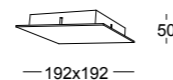

Fast opening and jack connection for easy installation



Recessed base

776/1I

Hole 35 mm.

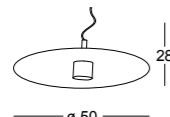

RECESSED BASE

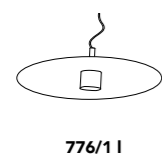

+

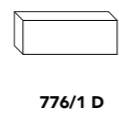

+

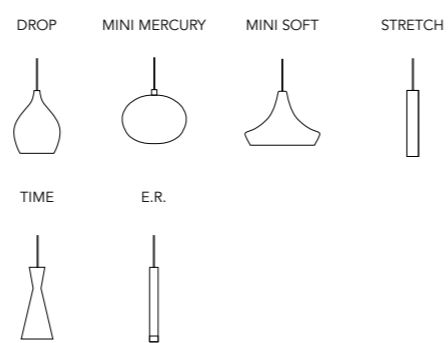

=

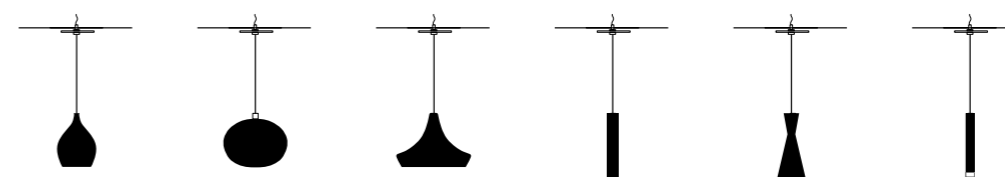

BASE FOR 1 MODULE

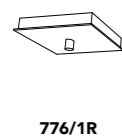

+

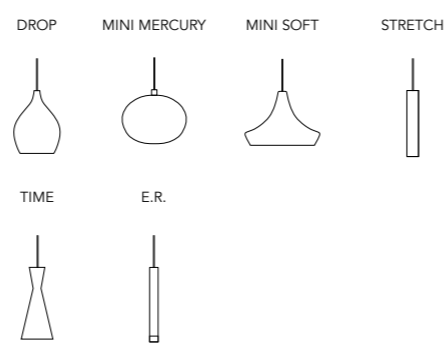

=

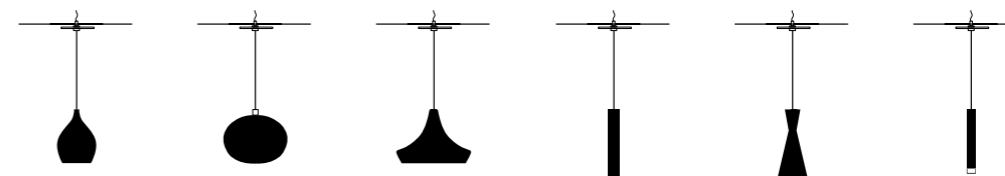

BASE WITH SIDE EXITS
2 to 4 modules



+

CABLE HOLDER
max 4 cables

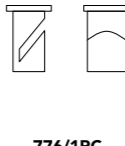

+

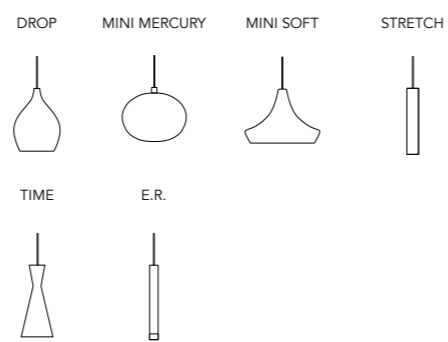

=

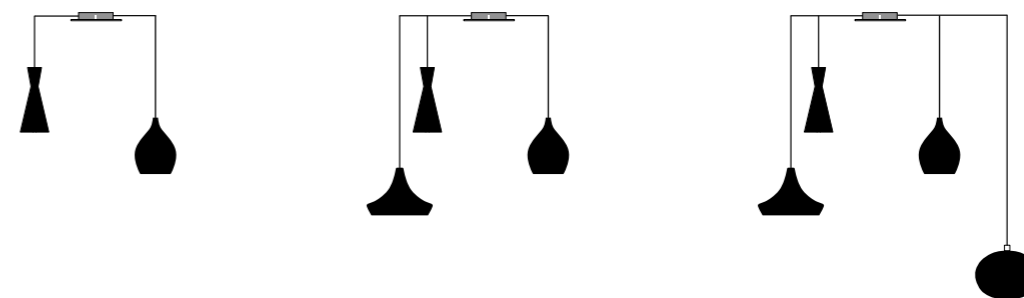

BASE WITH SIDE EXITS
5 to 8 modules

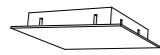

776/20R

+

CABLE HOLDER
max 4 cables

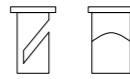

776/1RC

+

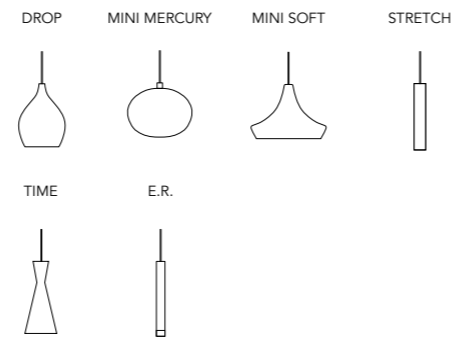

=

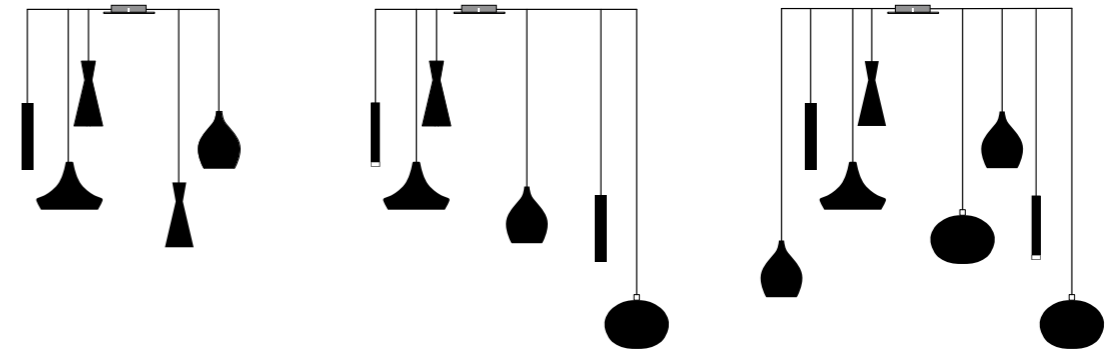

BASE WITH SIDE AND CENTRAL DESCENT
2 to 4 modules



776/16TC

+

CABLE HOLDER
max 4 cables

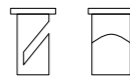

776/1RC

+

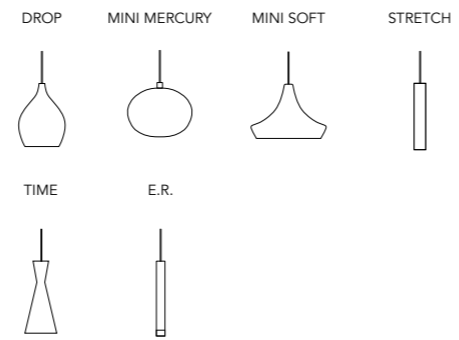

=

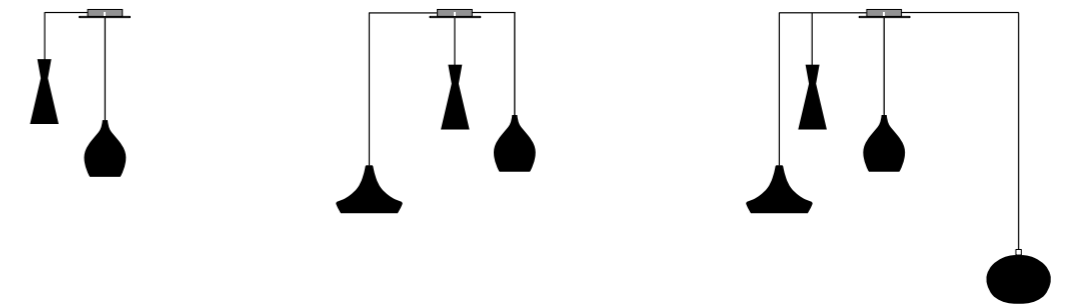

BASE WITH SIDE AND CENTRAL DESCENT
5 to 8 modules



776/20TC

+

CABLE HOLDER
max 4 cables

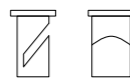

776/1RC

+

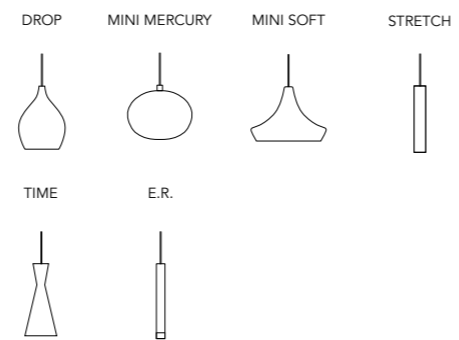

=

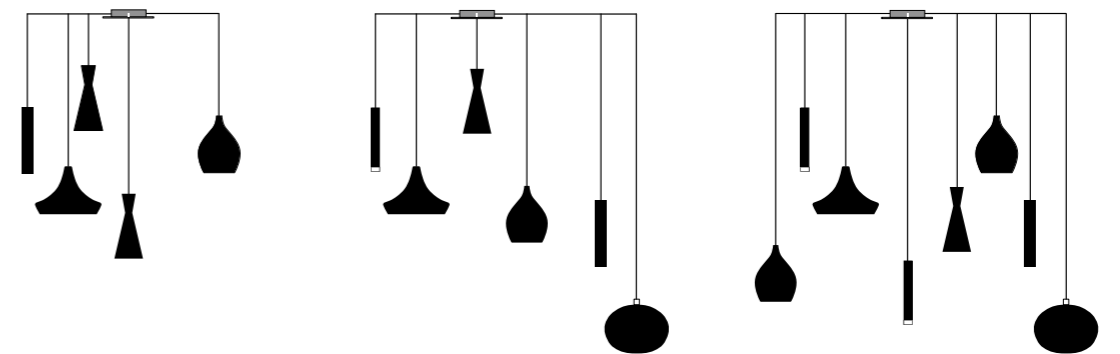

Head System

design C. Cattaneo

Crea la tua luce: sistema a sospensione con diverse forme compatibili. Incluso 3 lenti con differenti angolazioni, o diffusori per creare i tuoi punti di accento o la tua atmosfera.

Create your light: suspended system with several shapes, compatible with one another. To let you create your main lighting points or your atmosphere, three lens with different angles or diffusers are included.

Erstellen Sie Ihre eigene Lichtquelle. Pendelsysteme mit verschiedenen kompaktieblen Formen, inklusive 3 Linsen mit unterschiedlichen Strahlungswinkeln, sowie Lichtpunkte aus Glas können der Atmosphäre neue Akzente geben.



Nuts

design by C. Cattaneo

Sospensione in alluminio verniciato nelle colorazioni bianco, sabbia, nero, grigio e nei nuovi colori oro, bronzo, argento e ardesia, fornita di un led da 14w 1500 lumen dotata internamente di un rocchetto per il recupero del cavo in eccesso (fino a 2 metri) e di un appiglio esterno per potere inclinare la lampada con un gioco di cavi ed orientare la luce dove serve con collegamento tramite jack per un veloce e sicuro collegamento alla sua base con alimentatore.

Suspension lamp in painted aluminium in white, sand, black, grey and the new colours gold, bronze, silver and slate, equipped with a 14W 1500 lumen LED with a reel inside for recovering the excess cable (up to 2 metres) and an external handle to be able to tilt the lamp with a play of cables and direct the light where it is needed with a jack connection for fast and safe connection to its base with ballast.

Hängeleuchte aus lackiertem Aluminium in den Farben Weiß, Sand, Schwarz, Grau und den neuen Farben Gold, Bronze, Silber und Schiefer, ausgestattet mit einer LED mit 14W 1500 Lumen, mit einer inneren Kabelrolle zum Auffangen des überschüssigen Kabels (bis zu 2 Meter) und einem äußeren Griff, um die Leuchte mit einem Spiel von Kabeln kippen zu können und das Licht dorthin zu lenken, wo es benötigt wird, mit einem Klinkenanschluss für einen schnellen und sicheren Anschluss an die Basis mit Vorschaltgerät.





Module
780/14 S 3m / 5m / 7m / 10m / 15m
 LED 14W 700mA CC 1500lm 3000°K
 Net weight 665gr - Gross weight 1087gr
 Volume m³ 0,0084
 Dimmable 0 ~ 10VDC, or 10V PWM signal
 push or dali dimming upon request
 CE IP20

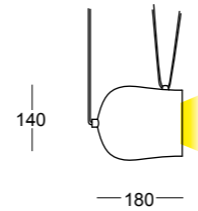

Standard colours

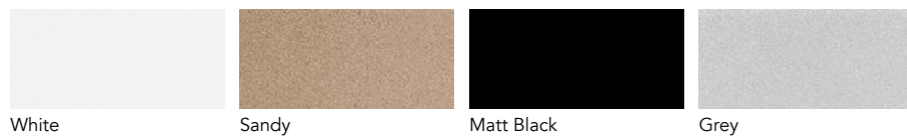

Module to be completed with one of the bases on page 482



Module
680/14 S 3m / 5m / 7m / 10m / 15m
 LED 14W 700mA CC 1500lm 3000°K
 Net weight 665gr - Gross weight 1087gr
 Volume m³ 0,0084
 Dimmable 0 ~ 10VDC, or 10V PWM signal
 push or dali dimming upon request
 CE IP20

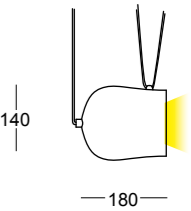

Special colours

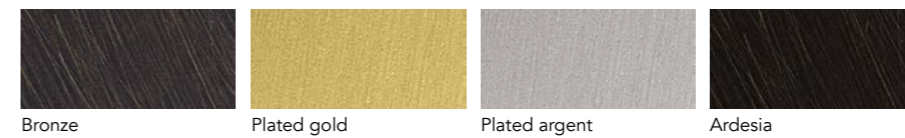

Module to be completed with one of the bases on page 482



Ball

design by C. Cattaneo

Sospensione in alluminio verniciato nelle colorazioni bianco, sabbia, nero, grigio e nei nuovi colori oro, bronzo, argento e ardesia, fornita di un led da 14w 1500 lumen dotata internamente di un rocchetto per il recupero del cavo in eccesso (fino a 2 metri) e di un appiglio esterno per potere inclinare la lampada con un gioco di cavi ed orientare la luce dove serve con collegamento tramite jack per un veloce e sicuro collegamento alla sua base con alimentatore.

Suspension lamp in painted aluminium in white, sand, black, grey and the new colours gold, bronze, silver and slate, equipped with a 14W 1500 lumen LED with a reel inside for recovering the excess cable (up to 2 metres) and an external handle to be able to tilt the lamp with a play of cables and direct the light where it is needed with a jack connection for fast and safe connection to its base with ballast.

Hängeleuchte aus lackiertem Aluminium in den Farben Weiß, Sand, Schwarz, Grau und den neuen Farben Gold, Bronze, Silber und Schiefer, ausgestattet mit einer LED mit 14W 1500 Lumen, mit einer inneren Kabelrolle zum Auffangen des überschüssigen Kabels (bis zu 2 Meter) und einem äußeren Griff, um die Leuchte mit einem Spiel von Kabeln kippen zu können und das Licht dorthin zu lenken, wo es benötigt wird, mit einem Klinkenanschluss für einen schnellen und sicheren Anschluss an die Basis mit Vorschaltgerät.





Module

865/18 S 3m / 5m / 7m / 10m / 15m

LED 14W 700mA CC 1500lm 3000°K

Net weight 700gr - Gross weight 1150gr

Volume m³ 0,0084

 0 ~ 10VDC, or 10V PWM signal
push or dali dimming upon request

CE  IP20

Standard colours



White

Sandy

Matt Black

Grey

Module to be completed with
one of the bases on page 482

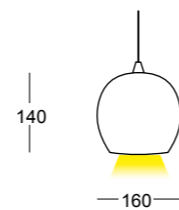

Module

665/18 S 3m / 5m / 7m / 10m / 15m

LED 14W 700mA CC 1500lm 3000°K

Net weight 700gr - Gross weight 1150gr

Volume m³ 0,0084

 0 ~ 10VDC, or 10V PWM signal
push or dali dimming upon request

CE  IP20

Special colours

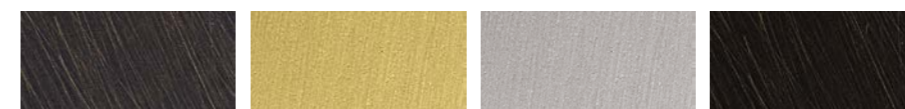

Bronze

Plated gold

Plated argent

Ardesia

Module to be completed with
one of the bases on page 482

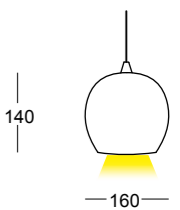

Cone

design by C. Cattaneo

Sospensione in alluminio verniciato nelle colorazioni bianco, sabbia, nero e grigio fornita di un led da 14w 1500 lumen dotata internamente di un rocchetto per il recupero del cavo in eccesso (fino a 2 metri) e di un appiglio esterno per potere inclinare la lampada con un gioco di cavi ed orientare la luce dove serve con collegamento tramite jack per un veloce e sicuro collegamento alla sua base con alimentatore.

Suspension in aluminium painted in white, sandy, black and grey colours equipped with a 14W 1500 lumens led equipped internally with a spool for the recovery of the excess cable (up to 2 metres) and with an external hook to be able to tilt the lamp with a play of cables and orient the light where it is needed. Jack connection for a quick and safe connection to its power supply.

Aufhängung aus lackiertem Aluminium in den Farben Weiß, Sand, Schwarz und Grau, ausgestattet mit einer 14 W 1500 Lumen LED, die intern mit einer Spule zur Rückgewinnung des überschüssigen Kabels (bis zu 2 Meter) und mit einem externen Handgriff ausgestattet ist, um die Lampe mit einem Kabelspiel kippen und das Licht dort ausrichten zu können, wo es benötigt wird, mit einem Klinkenanschluss für eine schnelle und sichere Verbindung zu ihrem Sockel mit einem Netzteil.





Module

867/12 S 3m / 5m / 7m / 10m / 15m

LED 14W 700mA CC 1500lm 3000°K

Net weight 570gr - Gross weight 870gr

Volume m³ 0,0069

Dimmable 0 ~ 10VDC, or 10V PWM signal
push or dali dimming upon request

CE IP20

Standard colours



White Sandy Matt Black Grey

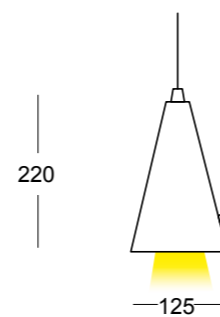

Module to be completed with
one of the bases on page 482



Module

667/12 S 3m / 5m / 7m / 10m / 15m

LED 14W 700mA CC 1500lm 3000°K

Net weight 570gr - Gross weight 870gr

Volume m³ 0,0069

Dimmable 0 ~ 10VDC, or 10V PWM signal
push or dali dimming upon request

CE IP20

Special colours

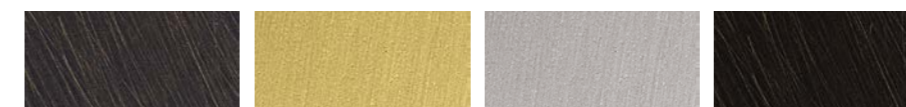

Bronze Plated gold Plated argent Ardesia

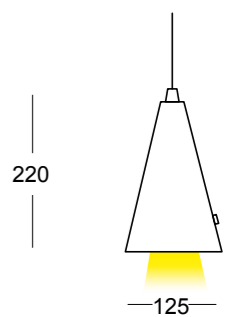

Module to be completed with
one of the bases on page 482

Base for 1 module

780/1 R

Net weight 910gr
Gross weight 1070gr
Volume m³ 0.0024

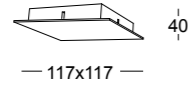

Up to 1 module



Bases with side exits

780/16 R

Net weight 1140gr
Gross weight 1293gr
Volume m³ 0.0024



1 to 3 modules

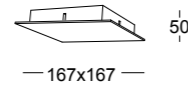

780/20 R

Net weight 2000gr
Gross weight 2600gr
Volume m³ 0.021

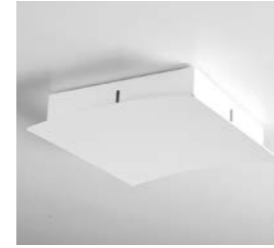

2 to 6 modules

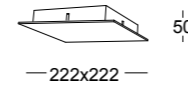

Cable Holder

776/1 RC

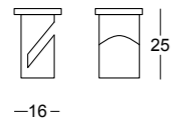
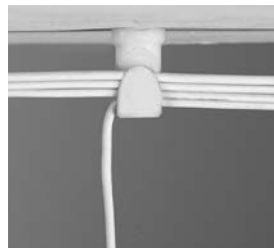

Bases with side and central descent

780/16 TC

Net weight 1140gr
Gross weight 1293gr
Volume m³ 0.0024



1 to 3 modules

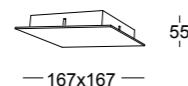

780/20 TC

Net weight 2000gr
Gross weight 2600gr
Volume m³ 0.021

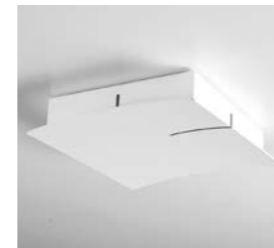

2 to 6 modules

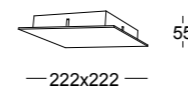

Head System Kit



120° without lens



Support for lens



28° lens



37° lens



50° lens



Concealed spool for recovery of excess cable

BASE FOR 1 MODULE



780/1R

+

CABLE HOLDER
max 4 cables



776/1RC

+

BALL



CONE



NUTS

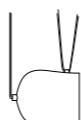

=

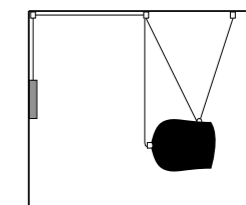
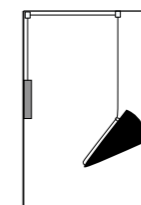
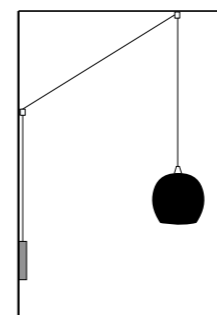

BASE WITH SIDE EXITS
up to 3 modules



780/16R

+

CABLE HOLDER
max 4 cables

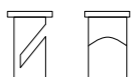

776/1RC

+

BALL



CONE



NUTS

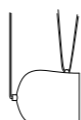

=

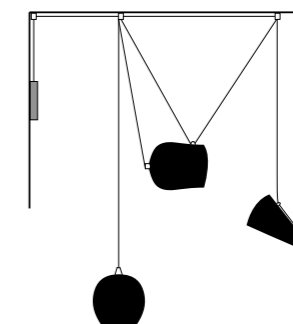
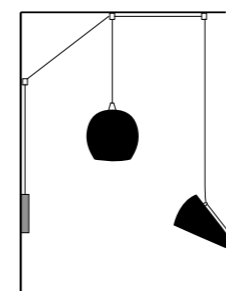

BASE WITH SIDE EXITS
4 to 6 modules



780/20R

+

CABLE HOLDER
max 4 cables

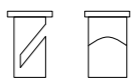

776/1RC

+

BALL



CONE



NUTS

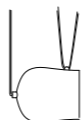

=

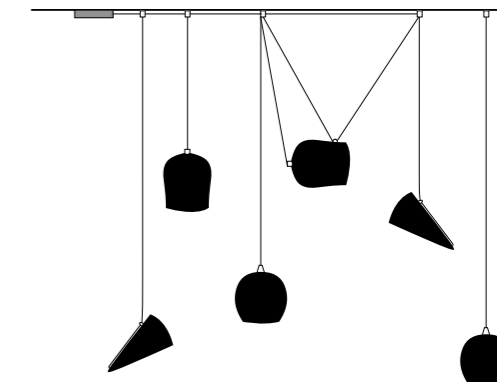
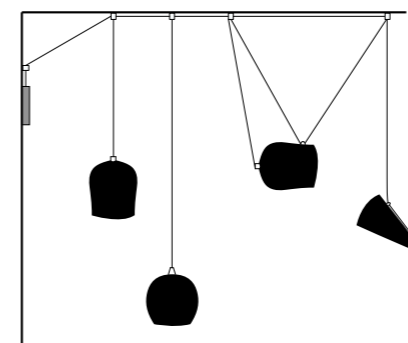

**BASE WITH SIDE
AND CENTRAL DESCENT**
up to 3 modules



780/16TC

+

CABLE HOLDER
max 4 cables

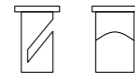

776/1RC

+

BALL



CONE



NUTS



=

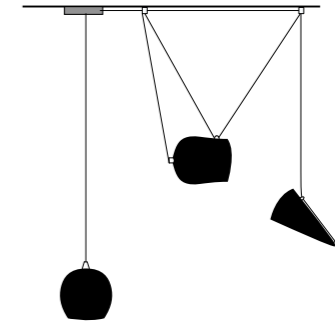
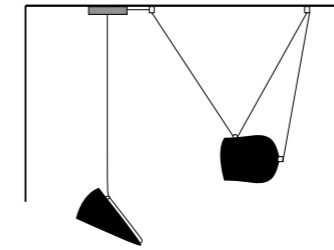

**BASE WITH SIDE
AND CENTRAL DESCENT**
4 to 6 modules



780/20TC

+

CABLE HOLDER
max 4 cables

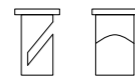

776/1RC

+

BALL



CONE



NUTS



=

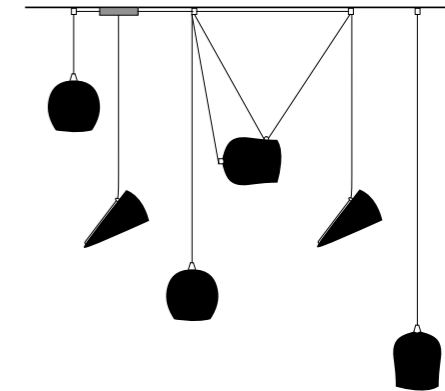
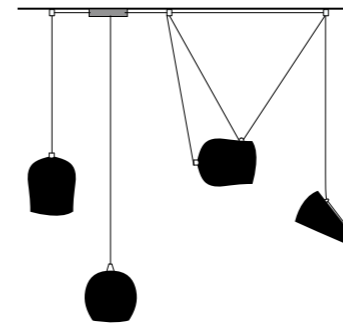

alphabetical index

ABBRACCIO	770/21 A	219
ABBRACCIO	770/36 A	219
ABBRACCIO	770/70 A	219
ADJUSTABLE	137/150 A	294
BALL	665/18 S	477
BALL	865/18 S	476
BASALT	897/60 P	169
BIQUADRO	879/60 S	199
BISCOTTO	765/60 PA	265
BISCOTTO	765/100 PA	265
BISCOTTO	765/100 S	263
BISCOTTO	765/130 PA	265
BISCOTTO	765/130 S	263
BOLLE	755/30 PA	289
BOLLE	755/30 S	287
BOLLE	755/60 PA	289
BOLLE	755/60 S	287
CENTRELINE	890/40 PA	202
CENTRELINE	890/70 PA	202
CENTRELINE	890/100 PA	202
CLEO	796/50 PA	24
CLEO	796/60 PA	24
CLEO	796/80 PA	24
CLEO	797/50 PA	28
CLEO	797/60 PA	28
CLEO	797/80 PA	28
CLOUD	708/50 S	309
CLOUD	713/50 S	309
CONE	667/12 S	481
CONE	867/12 S	480
CUBICK	767/5 A	233
CUBICK	767/5 L	238
CUBICK	767/7 A	233
CUBICK	767/7 L	238
CUBICK	767/9 A	233
CUBICK	767/9 L	238
CUBICK	768/5 P	234
CUBICK	768/5 S	237
CUBICK	768/7 P	234

CUBICK	768/7 S	237
CUBICK	768/9 P	234
CUBICK	768/9 S	237
CUBICK	899/5 A	231
CUBICK	899/7 A	231
CUBICK	899/9 A	231
DOMINO	871/20 PA	315
DOMINO	871/60 PA	314
DOMINO	872/20 C	315
DROP	786/13S	418
DROP	787/13 S	419
E.R.	847/30 S	454
E.R.	847/45 S	454
E.R.	848/30 S	454
E.R.	848/45 S	454
E.R.	849/30 S	458
E.R.	849/45S	458
E.R.	850/30 S	458
E.R.	850/45 S	458
EASY SYSTEM	776/1 D	460
EASY SYSTEM	776/1I	460
EASY SYSTEM	776/1 R	460
EASY SYSTEM	776/1RC	460
EASY SYSTEM	776/16 R	460
EASY SYSTEM	776/16 TC	460
EASY SYSTEM	776/20 R	460
EASY SYSTEM	776/20TC	460
FUORISQUADRA	764/25 PA	259
FUORISQUADRA	764/35 PA	259
FUORISQUADRA	764/50 PA	259
FUORISQUADRA	764/50 S	257
FUORISQUADRA	764/64 PA	259
FUORISQUADRA	764/64 S	257
FUORISQUADRA	764/100 PA	259
FUORISQUADRA	764/100 S	257
HEAD SYSTEM	780/1 R	482
HEAD SYSTEM	776/1 RC	482
HEAD SYSTEM	780/16 R	482
HEAD SYSTEM	780/16 TC	482

HEAD SYSTEM	780/20 R	482
HEAD SYSTEM	780/20 TC	482
HERON	810/15 R2	119
HERON	810/15 R3	119
HERON	810/75 ADS	107
HERON	810/75 PA	113
HERON	810/95 ADS	107
HERON	810/95 M	119
HERON	810/95 PA	113
HERON	810/95 S	118
HERON	810/120 ADS	107
HERON	810/120 M	119
HERON	810/120 PA	113
HERON	810/120 S	118
KAMI	791/30 A	90
KAMI	791/90 S	87
KAMI	791/120 S	87
KAMI	891/30A	91
KAMI	891/90 S	87
KAMI	891/120 S	87
KAMI UP&DOWN	991/120 S	79
KAMI UP&DOWN	992/120 S	78
KATANA	870/100 S	99
KATANA	870/100 S2	99
KATANA	870/130 S	99
KATANA	870/130 S2	99
KATANA	970/100 S	95
KATANA	970/100 S2	95
KATANA	970/130 S	95
KATANA	970/130 S2	95
LOGICA	925/130 S	74
LOGICA	925/150 S	74
LOGICA	926/130S	74
LOGICA	926/150 S	74
LOGICA	927/130 S	72
LOGICA	927/150 S	72
LOGICA	928/130 S	72
LOGICA	928/150S	72
LUCILLA	905/60 PA 1	400

alphabetical index

LUCILLA	905/60 PA 2	400
LUCILLA	905/60.100 PA2	404
LUCILLA	905/60.80 PA2	404
LUCILLA	905/80 PA1	400
LUCILLA	905/80 PA2	400
LUCILLA	905/80.100 PA	404
LUCILLA	905/100 PA1	400
LUCILLA	905/100 PA2	400
LUCILLA	905/20 PR	378
LUCILLA	905/30 PR	378
LUCILLA	905/40 PR	378
LUCILLA	905/50 PR	378
LUCILLA	905/60 PR	378
LUCILLA	905/70 PR	378
LUCILLA	905/80 PR	378
LUCILLA	905/90 PR	378
LUCILLA	905/100 PR	378
LUCILLA	905/110 PR	378
LUCILLA	905/120 PR	378
LUCILLA	905/130 PR	378
LUCILLA	905/140 PR	378
LUCILLA	905/150 PR	378
LUCILLA	905/160 PR	378
LUCILLA	905/170 PR	378
LUCILLA	905/180 PR	378
LUCILLA	905/190 PR	378
LUCILLA	905/200 PR	378
LUCILLA	905/120 S	396
LUCILLA	905/140 S	396
LUCILLA	905/160 S	396
LUCILLA	905/180 S	396
LUCILLA	905/200 S	396
LUCILLA	905/180 T	385
LUCILLA	905/18.20 T	387
LUCILLA	905/200 T	385
LUCILLA	906/20 PR	378
LUCILLA	906/30 PR	378
LUCILLA	906/40 PR	378
LUCILLA	906/50 PR	378

LUCILLA	906/60 PR	378
LUCILLA	906/70 PR	378
LUCILLA	906/80 PR	378
LUCILLA	906/90 PR	378
LUCILLA	906/100 PR	378
LUCILLA	906/110 PR	378
LUCILLA	906/120 PR	378
LUCILLA	906/130 PR	378
LUCILLA	906/140 PR	378
LUCILLA	906/150 PR	378
LUCILLA	906/160 PR	378
LUCILLA	906/170 PR	378
LUCILLA	906/180 PR	378
LUCILLA	906/190 PR	378
LUCILLA	906/200 PR	378
LUCILLA	907/15 R	379
LUCILLA	907/25 R	379
LUCILLA	908/1R	379
LUCILLA	908/2R	379
LUCILLA	908/A	379
LUCILLA	908/B	379
LUCILLA	909/15 R	379
LUCILLA	909/25 R	379
LUCILLA	910/1 P	377
LUCILLA	910/1 S	376
LUCILLA	911/60 S	350
LUCILLA	911/80 S	350
LUCILLA	915/60 PA2	410
LUCILLA	915/80 PA2	410
LUCILLA	915/100 PA2	410
LUCILLA	915/120 PA2	410
LUCILLA	915/140 PA2	410
LUCILLA	915/160 PA2	410
LUCILLA	915/160 TP	413
LUCILLA	915/180 TP	413
LUCILLA	915/200 TP	413
LUCILLA	938/100 S	348
LUCILLA	938/160 S	347
LUCILLA	938/200 S	346

LUCILLA	939/100 SP	374
LUCILLA	S905/A	379
LUCILLA	S905/B	379
LUCILLA	S905/C	379
LUCILLA	S905/D	379
LUCILLA	S905/E	379
LUCILLA	S905/L	379
LUCILLA	S905/T	379
LUCILLA	S906/A	379
LUCILLA	S906/B	379
LUCILLA	S906/C	379
LUCILLA	S906/D	379
LUCILLA	S906/DC	379
LUCILLA	S906/E	379
LUCILLA	S906/L	379
LUCILLA	S906/T	379
LUCILLA	S909/C	379
LUCILLA	S909/P	379
LUCILLA	S909/S	379
LUNATICA	792/20 A	38
LUNATICA	792/28 A	38
LUNATICA	793/28 A	38
LUNATICA	794/20 A	34
LUNATICA	794/28 A	34
LUNATICA	795/28 A	34
MICKEY	861/1 L	193
MICKEY	861/1 PA	188
MICKEY	861/3 PA	180
MICKEY	861/4 PA	181
MICKEY	861/6 PA	185
MINI MERCURY	784/16S	442
MINI SOFT	788/16 S	427
MINI SOFT	785/16S	426
NASSA	864/60 S	161
NASSA	864/80 S	161
NINFEA	895/70 P	177
NINFEA	895/90 P	177
NUTS	680 /14 S	471
NUTS	780/14S	470

alphabetical index

NUVOLA	630/30 L .	305
NUVOLA	630/30 PA	301
NUVOLA	630/30 S	299
NUVOLA	630/50 L	305
NUVOLA	630/50 PA	301
NUVOLA	630/50 S	299
OLIMPIA	862/16 PA	135
OLIMPIA TOUCH	862/16 DT	131
OLIMPIA TOUCH	962/16 DT	131
OLIMPIA	962/16PA	135
ORIONE	921/40 PA	44
ORIONE	921/60 PA	44
ORIONE	921/80 PA	44
ORIONE	922/40 PA	46
ORIONE	922/60 PA	46
ORIONE	922/80 PA	46
ORIONE	923/40 PA	48
ORIONE	923/60 PA	48
ORIONE	923/80 PA	48
ORIONE	924/40 PA	50
ORIONE	924/60 PA	50
ORIONE	924/80 PA	50
ORIONE	934/70 SP	60
ORIONE	934/80 SP	60
ORIONE	935/70 SP	62
ORIONE	935/80 SP	62
ORIONE	936/70 SP	64
ORIONE	936/80 SP	64
ORIONE	937/70 SP	66
ORIONE	937/80 SP	66
PLATEAU	773/20 P	271
PLATEAU	773/30 P	271
PLATEAU	773/40 P	271
PLATEAU	773/52 P	271
PLATEAU	773/52 S	269
PLATEAU	773/60 P	271
PLATEAU	773/60 S	269
QUADRETTO	761/10 A	223
RAYS	912/60 PA	154

RAYS	912/60 S	152
RAYS	912/80 PA	154
RAYS	912/80 S	152
RAYS	913/60 PA	157
RAYS	913/60 S	153
RAYS	913/80 PA	157
RAYS	913/80 S	153
RAYS	914/40 PA	156
SESAMO	836/35 PA	210
SESAMO	836/67 PA	210
SESAMO	836/95 PA	210
SESAMO	836/125 PA	210
SESAMO	836/155 PA	210
SMITH	904/2 A	329
SMITH	904/2 P	325
SMITH	904/2 S	323
SMITH	904/4 P	324
SMITH	904/4 S	321
SQUARE	860/20	149
STREET SYSTEM	873/20 PA	245
STREET	873/30 PA	251
STREET	873/45 PA	249
STREET	873/60 PA	253
STREET SYSTEM	873/80 PA	246
STREET SYSTEM	874/20 C	245
STRETCH	776/1S	450
STRETCH	769/1 S	451
TIME	783/11S	436
TIME	789/11 S	437
TRATTO	754/30 A	280
TRATTO	754/30A IP	280
TRATTO	754/30 PA	283
TRATTO	754/30 PA IP	283
TRATTO	754/60 A	279
TRATTO	754/60A IP	279
TRATTO	754/60 PA	283
TRATTO	754/60 PA IP	283
TRATTO	754/90 A	279
TRATTO	754/90A IP	279

TRATTO	754/90 PA	283
TRATTO	754/90 PA IP	283
TRATTO	754/90 S	275
TRATTO	774/60 A	281
TRATTO	774/60A IP	281
TRATTO	774/90 A	281
TRATTO	774/90A IP	281
VINTAGE	876/1 S	334
VINTAGE	876/14 PA	334
VINTAGE	876/14 V	334
VINTAGE	876/30 C	334
VINTAGE	876/45 C	334
VINTAGE	876/90 C	334
VINTAGE	876/CV	334
WATERFALLS	B.151/10	18
WATERFALLS	B.151/20	18
WATERFALLS	B.151/29	18
WATERFALLS	B.151/40	18
WATERFALLS	B.152/90	18
WATERFALLS	D.151/1	19
WATERFALLS	D.151/2	19
WATERFALLS	D.151/3	19
WATERFALLS	M151	19
WATERFALLS	M161	19
WELL	893/40 PA	125

numerical index

ADJUSTABLE	137/150 A	294
NUVOLA	630/30 L	305
NUVOLA	630/30 PA	301
NUVOLA	630/30 S	299
NUVOLA	630/50 L	305
NUVOLA	630/50 PA	301
NUVOLA	630/50 S	299
BALL	665/18 S	477
CONE	667/12 S	481
NUTS	680 /14 S	471
CLOUD	708/50 S	309
CLOUD	713/50 S	309
TRATTO	754/30 A	280
TRATTO	754/30 PA	283
TRATTO	754/30 PA IP	283
TRATTO	754/30 A IP	280
TRATTO	754/60 A	279
TRATTO	754/60 PA	283
TRATTO	754/60 PA IP	283
TRATTO	754/60A IP	279
TRATTO	754/90 A	279
TRATTO	754/90 PA	283
TRATTO	754/90 PA IP	283
TRATTO	754/90 S	275
TRATTO	754/90A IP	279
BOLLE	755/30 PA	289
BOLLE	755/30 S	287
BOLLE	755/60 PA	289
BOLLE	755/60 S	287
QUADRETTO	761/10 A	223
FUORISQUADRA	764/25 PA	259
FUORISQUADRA	764/35 PA	259
FUORISQUADRA	764/50 PA	259
FUORISQUADRA	764/50 S	257
FUORISQUADRA	764/64 PA	259
FUORISQUADRA	764/64 S	257
FUORISQUADRA	764/100 PA	259
FUORISQUADRA	764/100 S	257
BISCOTTO	765/60 PA	265

BISCOTTO	765/100 PA	265
BISCOTTO	765/100 S	263
BISCOTTO	765/130 PA	265
BISCOTTO	765/130 S	263
CUBICK	767/5 L	238
CUBICK	767/7 A	233
CUBICK	767/7 L	238
CUBICK	767/9 A	233
CUBICK	767/9 L	238
CUBICK	768/5 P	234
CUBICK	768/5 S	237
CUBICK	768/7 P	234
CUBICK	768/7 S	237
CUBICK	768/9 P	234
CUBICK	768/9 S	237
STRETCH	769/1 S	451
ABBRACCIO	770/21 A	219
ABBRACCIO	770/36 A	219
ABBRACCIO	770/70 A	219
PLATEAU	773/20 P	271
PLATEAU	773/30 P	271
PLATEAU	773/40 P	271
PLATEAU	773/52 P	271
PLATEAU	773/52 S	269
PLATEAU	773/60 P	271
PLATEAU	773/60 S	269
TRATTO	774/60 A	281
TRATTO	774/60A IP	281
TRATTO	774/90 A	281
TRATTO	774/90A IP	281
EASY SYSTEM	776/1 D	460
EASY SYSTEM	776/1 R	460
HEAD SYSTEM	776/1 RC	482
EASY SYSTEM	776/16 R	460
EASY SYSTEM	776/16 TC	460
EASY SYSTEM	776/1 I	460
EASY SYSTEM	776/1 RC	460
STRETCH	776/1 S	450
EASY SYSTEM	776/20 R	460

EASY SYSTEM	776/20 TC	460
HEAD SYSTEM	780/1 R	482
NUTS	780/14 S	470
HEAD SYSTEM	780/16 R	482
HEAD SYSTEM	780/16 TC	482
HEAD SYSTEM	780/20 R	482
HEAD SYSTEM	780/20 TC	482
TIME	783/11 S	436
MINI MERC.	784/16 S	442
MINI SOFT	785/16 S	426
DROP	786/13 S	418
DROP	787/13 S	419
MINI SOFT	788/16 S	427
TIME	789/11 S	437
KAMI	791/30 A	90
KAMI	791/90 S	87
KAMI	791/120 S	87
LUNATICA	792/20 A	38
LUNATICA	792/28 A	38
LUNATICA	793/28 A	38
LUNATICA	794/20 A	34
LUNATICA	794/28 A	34
LUNATICA	795/28 A	34
CLEO	796/50 PA	24
CLEO	796/60 PA	24
CLEO	796/80 PA	24
CLEO	797/50 PA	28
CLEO	797/60 PA	28
CLEO	797/80 PA	28
HERON	810/15 R2	119
HERON	810/15 R3	119
HERON	810/75 ADS	107
HERON	810/75 PA	113
HERON	810/95 ADS	107
HERON	810/95 M	119
HERON	810/95 PA	113
HERON	810/95 S	118
HERON	810/120 ADS	107
HERON	810/120 M	119

numerical index

HERON	810/120 PA	113
HERON	810/120 S	118
SESAMO	836/35 PA	210
SESAMO	836/67 PA	210
SESAMO	836/95 PA	210
SESAMO	836/125 PA	210
SESAMO	836/155 PA	210
E.R.	847/30 S	454
E.R.	847/45 S	454
E.R.	848/30 S	454
E.R.	848/45 S	454
E.R.	849/30 S	458
E.R.	849/45 S	458
E.R.	850/30 S	458
E.R.	850/45 S	458
SQUARE	860/20	149
MICKEY	861/1 L	193
MICKEY	861/1 PA	188
MICKEY	861/3 PA	180
MICKEY	861/4 PA	181
MICKEY	861/6 PA	185
OLIMPIA TOUCH	862/16 DT	131
OLIMPIA	862/16 PA	135
NASSA	864/60 S	161
NASSA	864/80 S	161
BALL	865/18 S	476
CONE	867/12 S	480
KATANA	870/100 S	99
KATANA	870/100 S2	99
KATANA	870/130 S	99
KATANA	870/130 S2	99
DOMINO	871/20 PA	315
DOMINO	871/60 PA	314
DOMINO	872/20 C	315
STREET SYST.	873/20 PA	245
STREET	873/30 PA	251
STREET	873/45 PA	249
STREET	873/60 PA	253
STREET SYST.	873/80 PA	246

STREET SYST.	874/20 C	245
VINTAGE	876/1 S	334
VINTAGE	876/14 PA	334
VINTAGE	876/14 V	334
VINTAGE	876/30 C	334
VINTAGE	876/45 C	334
VINTAGE	876/90 C	334
VINTAGE	876/CV	334
BIQUADRO	879/60 S	199
CENTRELINE	890/40 PA	202
CENTRELINE	890/70 PA	202
CENTRELINE	890/100 PA	202
KAMI	891/30 A	91
KAMI	891/90 S	87
KAMI	891/120 S	87
WELL	893/40 PA	125
NINFEA	895/70 P	177
NINFEA	895/90 P	177
BASALT	897/60 P	169
CUBICK	899/5 A	231
CUBICK	899/7 A	231
CUBICK	899/9 A	231
SMITH	904/2 A	329
SMITH	904/2 P	325
SMITH	904/2 S	323
SMITH	904/4 P	324
SMITH	904/4 S	321
LUCILLA	905/18.20 T	387
LUCILLA	905/20 PR	378
LUCILLA	905/30 PR	378
LUCILLA	905/40 PR	378
LUCILLA	905/50 PR	378
LUCILLA	905/60 PA 1	400
LUCILLA	905/60 PA 2	400
LUCILLA	905/60 PR	378
LUCILLA	905/60.100 PA2	404
LUCILLA	905/60.80 PA2	404
LUCILLA	905/70 PR	378
LUCILLA	905/80 PA1	400

LUCILLA	905/80 PA2	400
LUCILLA	905/80 PR	378
LUCILLA	905/80.100 PA2	404
LUCILLA	905/90 PR	378
LUCILLA	905/100 PA1	400
LUCILLA	905/100 PA2	400
LUCILLA	905/100 PR	378
LUCILLA	905/110 PR	378
LUCILLA	905/120 PR	378
LUCILLA	905/120 S	396
LUCILLA	905/130 PR	378
LUCILLA	905/140 PR	378
LUCILLA	905/140 S	396
LUCILLA	905/150 PR	378
LUCILLA	905/160 PR	378
LUCILLA	905/160 S	396
LUCILLA	905/170 PR	378
LUCILLA	905/180 PR	378
LUCILLA	905/180 S	396
LUCILLA	905/180 T	385
LUCILLA	905/190 PR	378
LUCILLA	905/200 PR	378
LUCILLA	905/200 S	396
LUCILLA	905/200 T	385
LUCILLA	906/20 PR	378
LUCILLA	906/200 PR	378
LUCILLA	906/30 PR	378
LUCILLA	906/40 PR	378
LUCILLA	906/50 PR	378
LUCILLA	906/60 PR	378
LUCILLA	906/70 PR	378
LUCILLA	906/80 PR	378
LUCILLA	906/90 PR	378
LUCILLA	906/100 PR	378
LUCILLA	906/110 PR	378
LUCILLA	906/120 PR	378
LUCILLA	906/130 PR	378
LUCILLA	906/140 PR	378
LUCILLA	906/150 PR	378

numerical index

LUCILLA	906/160 PR	378
LUCILLA	906/170 PR	378
LUCILLA	906/180 PR	378
LUCILLA	906/190 PR	378
LUCILLA	907/15 R	379
LUCILLA	907/25 R	379
LUCILLA	908/1R	379
LUCILLA	908/2R	379
LUCILLA	908/A	379
LUCILLA	908/B	379
LUCILLA	909/15 R	379
LUCILLA	909/25 R	379
LUCILLA	910/1 P	377
LUCILLA	910/1 S	376
LUCILLA	911/60 S	350
LUCILLA	911/80 S	350
RAYS	912/60 PA	154
RAYS	912/60 S	152
RAYS	912/80 PA	154
RAYS	912/80 S	152
RAYS	913/60 PA	157
RAYS	913/60 S	153
RAYS	913/80 PA	157
RAYS	913/80 S	153
RAYS	914/40 PA	156
LUCILLA	915/60 PA2	410
LUCILLA	915/80 PA2	410
LUCILLA	915/100 PA2	410
LUCILLA	915/120 PA2	410
LUCILLA	915/140 PA2	410
LUCILLA	915/160 PA2	410
LUCILLA	915/160 TP	413
LUCILLA	915/180 TP	413
LUCILLA	915/200 TP	413
ORIONE	921/40 PA	44
ORIONE	921/60 PA	44
ORIONE	921/80 PA	44
ORIONE	922/40 PA	46
ORIONE	922/60 PA	46

ORIONE	922/80 PA	46
ORIONE	923/40 PA	48
ORIONE	923/60 PA	48
ORIONE	923/80 PA	48
ORIONE	924/40 PA	50
ORIONE	924/60 PA	50
ORIONE	924/80 PA	50
LOGICA	925/130 S	74
LOGICA	925/150 S	74
LOGICA	926/130 S	74
LOGICA	926/150 S	74
LOGICA	927/130 S	72
LOGICA	927/150 S	72
LOGICA	928/130 S	72
LOGICA	928/150S	72
ORIONE	934/70 SP	60
ORIONE	934/80 SP	60
ORIONE	935/70 SP	62
ORIONE	935/80 SP	62
ORIONE	936/70 SP	64
ORIONE	936/80 SP	64
ORIONE	937/70 SP	66
ORIONE	937/80 SP	66
LUCILLA	938/100 S	348
LUCILLA	938/160 S	347
LUCILLA	938/200 S	346
LUCILLA	939/100 SP	374
OLIMPIA TOUCH	962/16 DT	131
OLIMPIA	962/16PA	135
KATANA	970/100 S	95
KATANA	970/100 S2	95
KATANA	970/130 S	95
KATANA	970/130 S2	95
KAMI UP&DOWN	991/120 S	79
KAMI UP&DOWN	992/120 S	78
WATERFALLS	B.151/10	18
WATERFALLS	B.151/20	18
WATERFALLS	B.151/29	18
WATERFALLS	B.151/40	18

WATERFALLS	B.152/90	18
WATERFALLS	D.151/1	19
WATERFALLS	D.151/2	19
WATERFALLS	D.151/3	19
WATERFALLS	M151	19
WATERFALLS	M161	19
LUCILLA	S905/A	379
LUCILLA	S905/B	379
LUCILLA	S905/C	379
LUCILLA	S905/D	379
LUCILLA	S905/E	379
LUCILLA	S905/L	379
LUCILLA	S905/T	379
LUCILLA	S906/A	379
LUCILLA	S906/B	379
LUCILLA	S906/C	379
LUCILLA	S906/D	379
LUCILLA	S906/DC	379
LUCILLA	S906/E	379
LUCILLA	S906/L	379
LUCILLA	S906/T	379
LUCILLA	S909/C	379
LUCILLA	S909/P	379
LUCILLA	S909/S	379



Design Materiali Funzionalità

Design • Materials • Functionality
Design • Materialien • Funktionalität

L'innovativa ricerca di materiali con i propri collaboratori personalizza i prodotti, aiutando il cliente in una scelta mirata al proprio stile. Alta qualità e buon Design Italiano caratterizzano il team di artigiani che collaborano con Cattaneo Illuminazione progettando con eleganza lo "Spazio illuminazione" per trasformare il lavoro in un vero e proprio laboratorio di idee.

The innovative research for materials in cooperation with its own partners personalizes the products, helping customers choosing the most suitable fitting for their style. High quality and good Italian Design distinguish the team of artisans cooperating with Cattaneo Illuminazione, who elegantly design the "Lighting Field" transforming work into a real ideas workshop.

Die innovative Suche nach Materialien mit ihren Mitarbeitern ermöglicht Ihnen der Produkte zu anpassen. Es hilft dem Kunden, eine Wahl nach seinem eigenen Stil zu treffen. Hohe Qualität und gutes italienisches Design zeichnen aus das Team von Handwerkern, die mit Cattaneo zusammenarbeiten. Der "Lichtraum" ist elegant gestaltet. Die Arbeit wird so zu einem echten Ideenlabor.

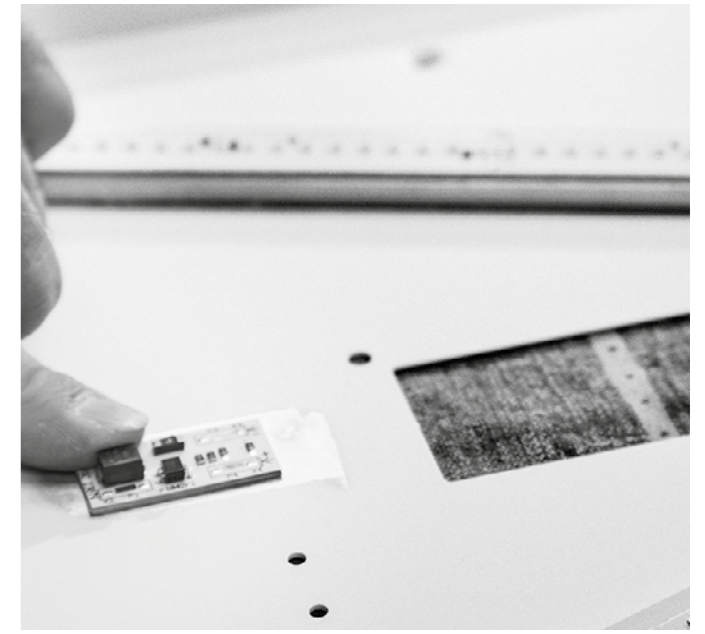

Le tecnologie ci aiutano a vivere i nostri attimi quotidiani e anche nell'illuminazione la ricerca e lo sviluppo di nuovi sistemi illuminanti ha permesso a Cattaneo Illuminazione di creare e ottimizzare nuovi apparecchi, attenti, non solo alle esigenze del mercato, ma anche alla giusta relazione tra persona, ambiente e corretta visione della luce.

La sinergia tra creatività e tecnologia ha potuto creare lampade a basso consumo energetico e a LED con alte prestazioni illuminotecniche, che grazie all'utilizzo di schermi protettivi e alla ricerca nella disposizione del bulbo illuminante, permettono un' ergonomica e corretta illuminazione nell'ambiente.

Da oltre quarant'anni, Cattaneo Illuminazione propone creazioni che scaturiscono dalla fantasia e dalla manualità di qualificati artigiani italiani. La ricerca estetica, l' attenta selezione dei materiali, accurata esecuzione

Technology helps us in our daily lives; as for lighting, research and development have allowed Cattaneo Illuminazione to design and optimize new light fixtures focusing not only on the needs of the market, but also on the right balance among people, interiors and suitable lighting solutions. Synergy between creativity and technology has led to the design of low-energy and high-performance LED fittings, equipped with appropriate screens and specially-positioned bulbs so as to ensure a suitable ergonomic interior lighting.

For over forty years, Cattaneo Illuminazione has been offering lighting creations arising from the imagination and craftsmanship of skilled Italian artisans. Aesthetic research, careful selection of materials and accurate finishes are combined to offer top quality products, exclusively made

Technologien helfen unsere alltaeglichen Momente zu leben, das gilt auch fuer die Beleuchtung die durch Forschung, Entwicklung und Ausruestung neuer Beleuchtungssysteme von Cattaneo Illuminazione nicht nur auf die Marktbeduefnisse sondern auch auf die Beziehung zwischen Mensch, Umwelt und die richtige Vision von Licht konzipiert sind. Durch die Sinergie von Kreativitaet und Technologien ist es gelungen, energieeffiziente Lampen und LED Beleuchtung mit hoher Leistung, ausgestattet mit einer Schutzscheibe und der richtigen Anordnung der Gluehbirne, eine optimale Beleuchtung und ergonomische Umwelt zu ermöglichen.

Seit über vierzig Jahren bietet Cattaneo Illuminazione, Kreationen, welche aus der Phantasie und Kunstfertigkeit des Italienischen Handwerk, entstehen. Das Aussehen, die sorgfältige Auswahl der Materialien, präzise

delle finiture: tutto ciò consente di offrire prodotti di alta qualità, che vengono sempre realizzati esclusivamente in Italia ed in Europa.

Con l'esperienza e l'organizzazione Cattaneo Illuminazione offre un full-service all'installatore o architetto, in modo tale che questi possano arricchire e integrare nel proprio progetto maggiori informazioni per i loro clienti. La velocità del customer services è lo strumento preferito dalla Cattaneo illuminazione per poter creare un rapporto di fiducia e professionalità con il cliente, ed è proprio da questo atteggiamento che scaturiscono idee e progetti interessanti soprattutto nell'ambito della fornitura di hotel, open space e grandi installazioni.

L'entusiasmo di Cattaneo illuminazione vuole essere: "La scintilla di creatività che dall'Italia illumina il mondo".

in Italy and Europe. Thanks to its experience and organization, Cattaneo Illuminazione can provide architects and installers with a full service, including extensive project and technical support. A prompt customer service is of the utmost importance for Cattaneo Illuminazione to establish a trustworthy, professional relationship with its customers, which is the basis of interesting ideas and projects, especially as far as hotels, open spaces and large installations are concerned.

Cattaneo Illuminazione is the spark of Italian creativity that lights up the world.

Ausführungen, all dies ermöglicht es uns, qualitativ hochwertige Produkte anzubieten, die ausschliesslich in Europa und Italien hergestellt werden.

Basierend auf die Erfahrung und der Organisation bietet Cattaneo Illuminazione einen umfassenden Service fuer Installateure und Architekten, damit deren Kundenprojekte entsprechend bereichert, sowie mit mehr Informationen entsprechend integriert werden koennen. Die Geschwindigkeit und ein ausgepraegter Customer Service ist fuer Cattaneo Illuminazione, der entscheidende Aspekt, eine professionelle Vertrauensbasis mit den Kunden zu schaffen, um Ideen und interessante Projekte, vor allem in der Ausstattung von Hotel, Freiflächen und großen Installationen, zu entwickeln.

Ein Funken an Kreativitaet welcher von Italien aus die Welt beleuchtet entspricht dem Entusiasmo von Cattaneo Illuminazione.

Graphic design
Alessandra Carù

Photography
Bordegoni

Copyright © Cattaneo sas 2024

Reference images by gracious permission
of our customers

Cattaneo Illuminazione si riserva la facoltà
di modificare, in qualsiasi momento e senza
preavviso, le caratteristiche tecniche
dei modelli illustrati nel presente catalogo.
I colori si intendono indicativi.

*Cattaneo illuminazione reserves the right
to change the technical features
of the items in the catalogue at any time
without prior notice.
The colours shown are intended to show
the approximate colour of the finish.*

*Cattaneo Illuminazioni behält sich
das Recht vor, jederzeit und ohne
vorherige Ankündigung, die technischen
Eigenschaften der Modelle in diesem
Katalog zu modifizieren.
Die Farben sind indikativ.*

Cattaneo sas

Via P. da Volpedo, 10
20092 Cinisello Balsamo - Milano - Italy
t. (+39) 02 6604.6582
t. (+39) 02 6601.8303
cattaneo@cattaneo.it
export@cattaneo.it

www.cattaneo.it